



Description

The CYT6118 is an efficient linear voltage regulator. It has extra low dropout voltage. At light loads the typical dropout voltage is 4.6mV, at full load the typical dropout voltage is 300mV. The output voltage accuracy is better than 2%.

The CYT6118 has low ground current, so it can help prolong battery life. The CYT6118 is specially designed for hand-held, battery-powered devices.

Features

- Typical 90mV dropout voltage at 150mA.
- Guaranteed 500mA output over the full operating temperature range.
- Low 300mV typical dropout voltage at full load.
- Extremely tight load and line regulation.
- Low temperature coefficient.
- Current and thermal limiting.
- No-load stability.
- Standard SOT-89-3 package.

Pin Configuration

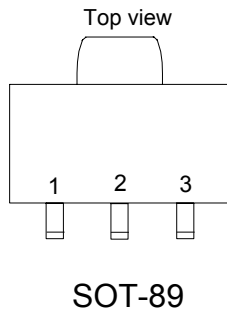

Applications

- Active SCSI terminators.
- Post regulators for switching supplies.
- Battery chargers.
- High-efficiency linear power supplies.
- Computer motherboard, display, graphic card DC/DC converter, such as 5V to 3.3V, 3.3V to 2.8V or 3.3V to 2.5V.

Typical Application

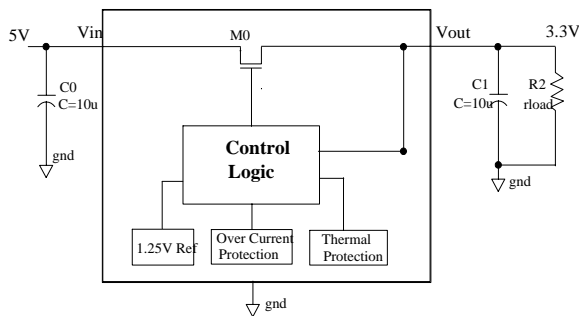

Ordering Information

- CYT6118
- ↑↑↑ PIN (1=>3): 1. G: OUT/GND/IN
 - ↑↑↑ Package Type: 1. K: SOT-89-3L
 - ↑↑↑ Output Voltage: 1. A: $V_{OUT} = 3.3V$
 - 2. B: $V_{OUT} = 2.8V$
 - 3. C: $V_{OUT} = 2.5V$
 - 4. D: $V_{OUT} = 1.8V$
 - 5. E: $V_{OUT} = 1.5V$



500mA CMOS LDO Regulator

CYT6118

Absolute Maximum Ratings⁽¹⁾

Supply Input Voltage (V_{IN}) -0.7V to +7V
 Power Dissipation (P_D) Internally Limited⁽³⁾
 Junction Temperature (T_J) 0°C to +125°C
 Lead Temperature (soldering, 5 sec.) 260°C
 Storage Temperature (T_S) -10°C to +150°C

Operating Ratings⁽²⁾

Supply Input Voltage (V_{IN}) +2.5V to +6V
 Junction Temperature (T_J) 0°C to +125°C
 Package Thermal
 Resistance 120°C /W

Electrical Characteristics

$V_{IN} = V_{OUT} + 1.0V$; $C_{OUT} = 4.7\mu F$, $I_{OUT} = 10mA$; $T_J = 25^\circ C$; unless otherwise specified.

Symbol	Parameter	Conditions	Min	Typ	Max	Units	
V_{OUT}	Output Voltage Accuracy	CYT6118-1.5V	1.470	1.5	1.530	V	
		CYT6118-1.8V	1.764	1.8	1.836		
		CYT6118-2.5V	2.450	2.5	2.550		
		CYT6118-2.8V	2.744	2.8	2.856		
		CYT6118-3.3V	3.234	3.3	3.366		
$\Delta V_{OUT} / \Delta T$	Output Voltage Temperature Coefficient	Note 4	--	40	--	ppm/°C	
$\Delta V_{OUT} / V_{OUT}$	Line Regulation	$V_{IN} = V_{OUT} + 1V$ to 5.5V	--	0.3	--	%	
$\Delta V_{OUT} / V_{OUT}$	Load Regulation ⁽⁵⁾	$I_{OUT} = 10mA$ to 500mA ⁽⁵⁾	--	0.5	--	%	
$V_{IN} - V_{OUT}$	Dropout Voltage ⁽⁶⁾	$V_{OUT} < 2V$	$I_{OUT} = 10mA$	--	9	--	mV
			$I_{OUT} = 150mA$	--	175	--	
			$I_{OUT} = 500mA$	--	530	--	
		$V_{OUT} > 2V$	$I_{OUT} = 10mA$	--	4.6	--	mV
			$I_{OUT} = 150mA$	--	90	--	
			$I_{OUT} = 500mA$	--	300	--	
$T_{PROTECTION}$	Thermal Protection	Thermal Protection Temperature	--	150	--	°C	
		Protection Hysteresis	--	30	--	°C	
PSRR	Ripple Rejection	$f = 120Hz$	--	35	--	dB	
I_{GROUND}	Ground Current	$I_{OUT} = 10mA$	--	1	--	mA	
I_{LIMIT}	Current Limit	$V_{OUT} = 0V$	--	1.5	--	A	



Note 1: Exceeding the absolute maximum rating may damage the device.

Note 2: The device is not guaranteed to function outside its operating rating.

Note 3: The maximum allowable power dissipation at any TA (ambient temperature) is calculated using: $P_{D(MAX)} = (T_{J(MAX)} - T_A)/\theta_{JA}$. Exceeding the maximum allowable power dissipation will result in excessive die temperature, and the regulator will go into thermal shutdown. See Table 1 and the “Thermal Considerations” section for details.

Note 4: Output voltage temperature coefficient is the worst-case voltage change divided by the total temperature range.

Note 5: Regulation is measured at constant junction temperature using low duty cycle pulse testing. Parts are tested for load regulation in the load range from 100 μ A to 500mA. Changes in output voltage due to heating effects are covered by the thermal regulation specification.

Note 6: Dropout voltage is defined as the input to output differential at which the output voltage drops 2% below its nominal value measured at 1V differential.



Application Hints

Like any Low dropout regulator, CYT6118 requires external capacitors to ensure stability. The external capacitors must be carefully selected to ensure the performances.

Input Capacitor:

An Input Capacitor of at least 10uF is required.

Ceramic or Tantalum can be used. The value can be increased without upper limit.

Output Capacitor:

An Output Capacitor is required for look stability. It must be located no more than 1cm away from the V_{OUT} pin, and connected directly between V_{OUT} and GND pins. The minimum value is 10uF but once again its value can be increased without limit.

Thermal Consideration

It is important that the thermal limit of the package should not be exceeded. The CYT6118 has built-in thermal protection. When the thermal limit is exceeded, the IC will enter protection, and the V_{OUT} will be reset to zero. The power dissipation for a given application can be calculated as follows:

The Power Dissipation (P_D) is

$$P_D = I_{OUT} * [V_{IN} - V_{OUT}]$$

The thermal limit of the package is then limited to

$P_{D(MAX)} = [T_J - T_A]/\theta_{JA}$ where T_J is the junction temperature, T_A is ambient temperature, and θ_{JA} is around 120°C/W for CYT6118. CYT6118 is designed to enter thermal protection at 150°C. For example, if T_A is 25°C then the max P_D is limited to about 1W. In other words, if $I_{OUT(MAX)} = 500mA$, then $[V_{IN} - V_{OUT}]$ can not exceed 2.1V.



500mA CMOS LDO Regulator

CYT6118

Typical Performance Characteristics

($V_{IN} = 5V$, $C_{IN} = 1\mu F$, $C_{OUT} = 10\mu F$, $T_A=25^\circ C$, unless otherwise noted.)

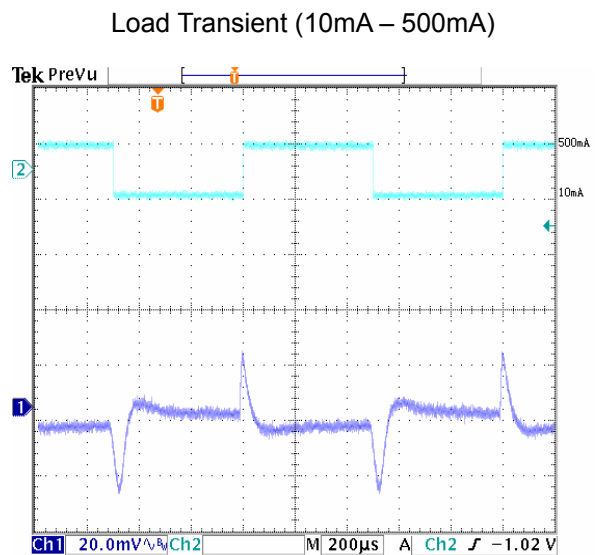
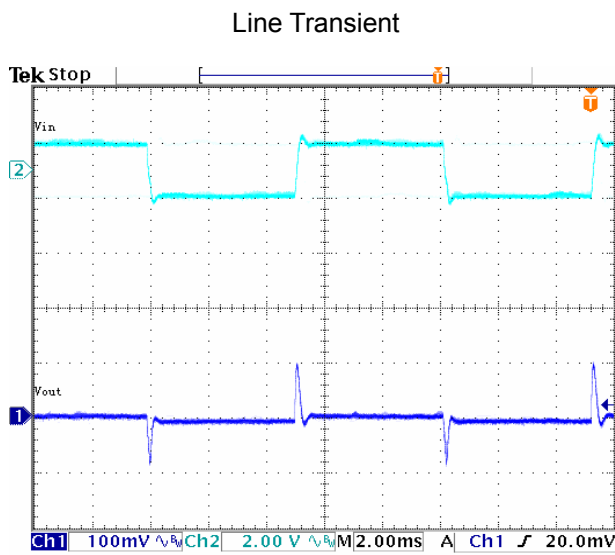
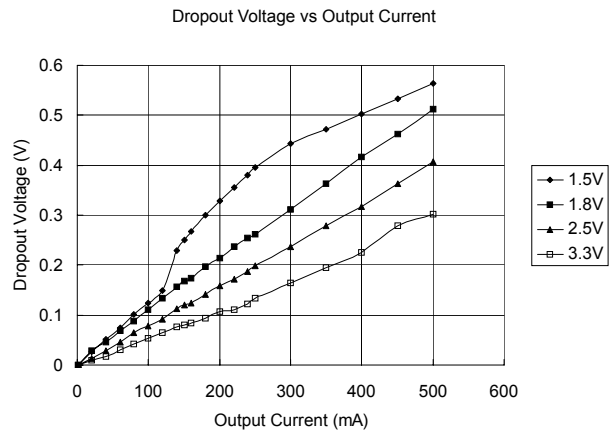
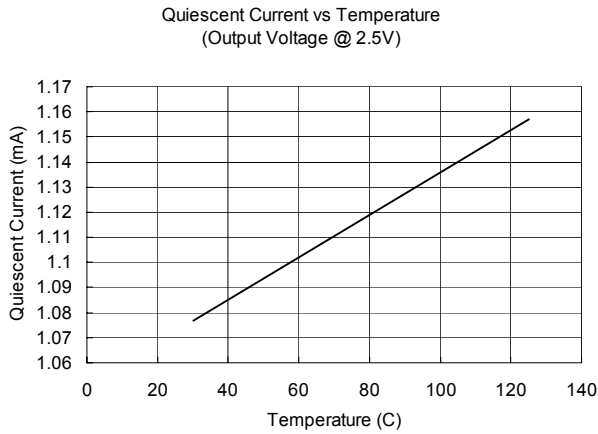
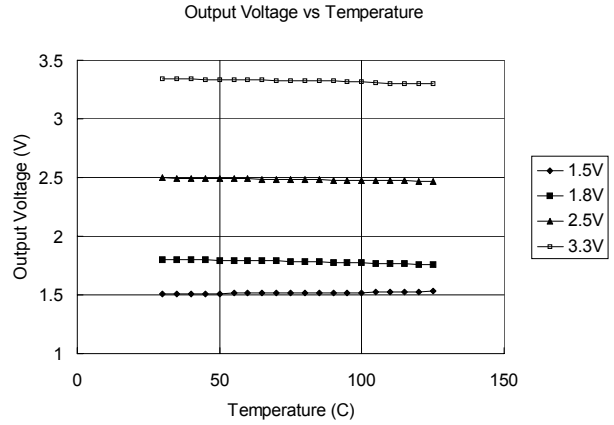
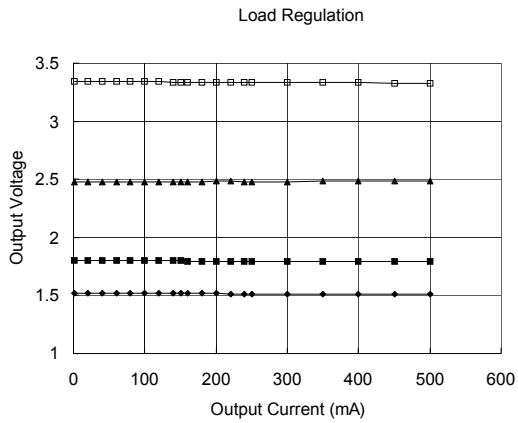

All contents are subject to change without prior notice.



500mA CMOS LDO Regulator

CYT6118

Outline Drawing for SOT-89

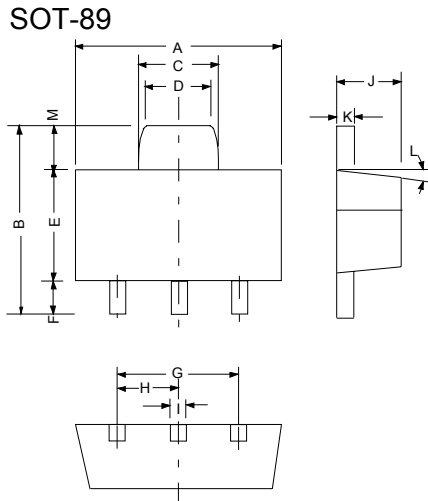

DIMENSIONS				
DIM ^N	INCHES		MM	
	MIN	MAX	MIN	MAX
A	0.173	0.181	4.400	4.600
B	0.159	0.167	4.050	4.250
C	0.067	0.075	1.700	1.900
D	0.051	0.059	1.300	1.500
E	0.094	0.102	2.400	2.600
F	0.035	0.047	0.890	1.200
G	0.118REF		3.00REF	
H	0.059REF		1.50REF	
I	0.016	0.020	0.400	0.520
J	0.055	0.063	1.400	1.600
K	0.014	0.016	0.350	0.410
L	10°TYP		10°TYP	
M	0.028REF		0.70REF	