

MN4066B / MN4066BS

Quad Analog Switches

■ Description

The MN4066B/S have 4 independent analog switches. A High on the enable input establishes a low impedance state (ON stage) between input and output of the switch. A Low establishes a high impedance (OFF stage).

MN4066B is pin-compatible to MN4016B. But MN4066B has low R_{ON} and better transfer characteristics. So applications are for analog/digital switching and chopper modulation and demodulation.

The MN4066B/S are equivalent to MOTOROLA MC14066B and RCA CD4066B.

■ Schematic Diagram (1/4)

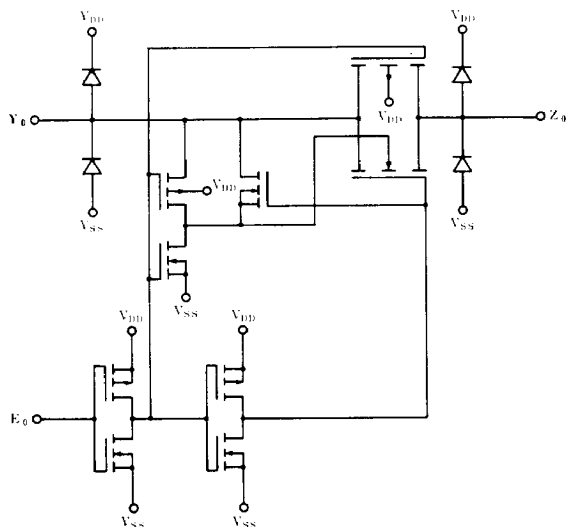

P-1

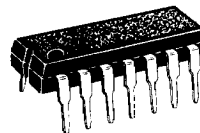

14-Pin • Plastic DIL Package

P-2



14-Pin • Panaflat Package (SO-14D)

Pin Configuration

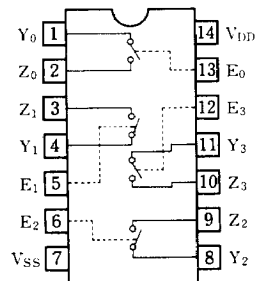

Pin Explanation

- $E_0 \sim E_3$: Enable input
- $Y_0 \sim Y_3$: Analog input/output
- $Z_0 \sim Z_3$: Analog input/output

■ Maximum Ratings (Ta=25°C)

Item	Symbol	Ratings	Unit
Supply Voltage	V _{DD}	-0.5~+18	V
Input Voltage	V _I	-0.5~V _{DD} +0.5*	V
Output Voltage	V _O	-0.5~V _{DD} +0.5*	V
Peak Input · Output Current	±I _I	max. 10	mA
Power Dissipation (per package)	P _D	max. 400	mW
		Decrease up to 200mW rating at 8mW/°C	
Power Dissipation (peroutput terminal)	P _D	max. 100	mW
Operating Ambient Temperature	T _{opr}	-40~+85	°C
Storage Temperature	T _{stg}	-65~+150	°C

* V_{DD} + 0.5V should be under 18V

■ DC Characteristics (V_{SS}=0V)

Item	V _{DD} (V)	Sym- bol	Conditions	Ta=-40°C		Ta=25°C		Ta=85°C		Unit
				min.	max.	min.	max.	min.	max.	
Quiescent Power Supply Current	5	I _{DD}	V _I =V _{SS} or V _{DD}	—	1	—	1	—	7.5	μA
	10			—	2	—	2	—	15	
	15			—	4	—	4	—	30	
Input Voltage Low Level	5	V _{IL}	I _O < 1μA V _O =0.5V or 4.5V	—	1.5	—	1.5	—	1.5	V
	10			—	3	—	3	—	3	
	15			—	4	—	4	—	4	
Input Voltage High Level	5	V _{IH}	I _O < 1μA V _O =0.5V or 4.5V	3.5	—	3.5	—	3.5	—	V
	10			7	—	7	—	7	—	
	15			11	—	11	—	11	—	
Input Leakage Current	15	±I _I	V _I =0 or 15V.	—	0.3	—	0.3	—	1	μA

■ DC Characteristics (Ta=25°C, V_{SS}=0V)

Item	V _{DD} (V)	Symbol	Conditions	min.	typ.	max.	Unit
On Resistance	5	R _{ON}	V _{SS} =0V, V _I =5V	—	150	450	Ω
			V _{SS} =0V, V _I =2.5V	—	380	1140	
			V _{SS} =0V, V _I =0.25V	—	150	450	
	10	R _{ON}	V _{SS} =0V, V _I =10V	—	80	250	Ω
			V _{SS} =0V, V _I =5V	—	100	300	
			V _{SS} =0V, V _I =0.25V	—	100	300	
	15	R _{ON}	V _{SS} =0V, V _I =15V	—	60	180	Ω
			V _{SS} =0V, V _I =7.5V	—	70	210	
			V _{SS} =0V, V _I =0.25V	—	60	180	
	5	R _{ON}	V _{SS} =-5V, V _I =5V	—	100	300	Ω
			V _{SS} =-5V, V _I =±0.25V	—	100	300	
			V _{SS} =-5V, V _I =-5V	—	100	300	
7.5	R _{ON}	V _{SS} =-7.5V, V _I =7.5V	—	70	210	Ω	
		V _{SS} =-7.5V, V _I =±0.25V	—	70	210		
		V _{SS} =-7.5V, V _I =-7.5V	—	70	210		
Input Output of Leakage Current	10	I _{OFF}	V _I =10V, V _O =0V	—	30	125	nA
			V _I =0V, V _O =10V	—	30	125	
	15		V _I =15V, V _O =0V	—	60	250	nA
			V _I =0V, V _O =15V	—	60	250	

■ Switching Characteristics (Ta=25°C, VSS=0V)

Item	V _{DD} (V)	Symbol	Conditions	min.	typ.	max.	Unit
Propagation Delay Time (Fig. 1) Vis → Vos	5	t _{PHL}	R _L = 10kΩ C _L = 50pF E _n = V _{DD}	—	10	30	ns
	10			—	5	15	
	15			—	5	15	
Propagation Delay Time (Fig. 1) Vis → Vos	5	t _{PLH}	E _n = V _{DD}	—	10	30	ns
	10			—	5	15	
	15			—	5	15	
Propagation Delay Time (Fig. 1) E _n → Vos	5	t _{PHZ}	R _L = 10kΩ, C _L = 50pF Vis = V _{DD} , R _L → V _{SS}	—	80	240	ns
	10			—	65	195	
	15			—	60	180	
Propagation Delay Time (Fig. 1) E _n → Vos	5	t _{PLZ}	R _L = 10kΩ, C _L = 50pF Vis = V _{SS} , R _L → V _{DD}	—	80	240	ns
	10			—	70	210	
	15			—	70	210	
Propagation Delay Time (Fig. 1) E _n → Vos	5	t _{PZH}	R _L = 10kΩ, C _L = 50pF Vis = V _{DD} , R _L → V _{SS}	—	40	120	ns
	10			—	20	60	
	15			—	15	45	
Propagation Delay Time (Fig. 1) E _n → Vos	5	t _{PZL}	R _L = 10kΩ, C _L = 50pF Vis = V _{SS} , R _L → V _{DD}	—	45	135	ns
	10			—	20	60	
	15			—	15	45	
Sine Wave Distortion (Fig. 2)	5		R _L = 10kΩ, C _L = 50pF E _n = V _{DD} , f = 1 kHz Vis = ½ V _{DD} (P-P)	—	—	—	%
	10			—	0.1	—	
	15			—	0.1	—	
Crosstalk (Fig. 3) (Between 2 Channels)	5		R _L = 1 kΩ Vis = ½ V _{DD} (P-P)	—	—	—	MHz
	10			—	1	—	
	15			—	—	—	
Crosstalk (Fig. 1) E _n → V _{SS}	5		R _L = 1 kΩ, C _L = 15pF E _n = V _{DD}	—	—	—	mV
	10			—	80	—	
	15			—	—	—	
Feedthrough (Fig. 2)(Note) (OFF)	5		R _L = 1 kΩ, C _L = 50pF E _n = V _{SS} , Vis = ½ V _{DD} (P-P)	—	—	—	kHz
	10			—	700	—	
	15			—	—	—	
Input Capacitance		C _I		—	—	7.5	pF

Fig. 1 Propagation Delay Time, Crosstalk Test Circuit Fig. 2 Sine Wave Distortion, Feedthrough Test Circuit

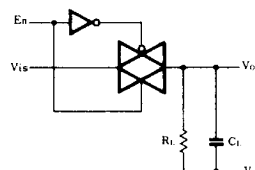
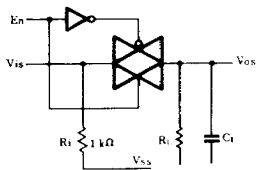

(Note) $20 \log \frac{V_{os}}{V_{is}} = -50\text{dB}$

Fig. 3 Crosstalk Test Circuit

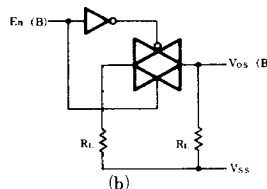
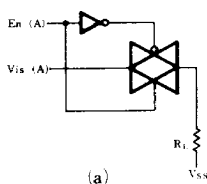

$20 \log \frac{V_{os} (B)}{V_{is} (A)} = -50\text{dB}$