

CMOS 8-Bit Microcontroller

TMP87PM78F

The 87PM78 is a One-Time PROM microcontroller with low-power 256 K bits (32 Kbytes) electrically programmable read only memory for the 87CC78/CH78/CK78/CM78 system evaluation. The 87PM78 is pin compatible with the 87CC78/CH78/CK78/CM78. The operations possible with the 87CC78/CH78/CK78/CM78 can be performed by writing programs to PROM. The 87PM78 can write and verify in the same way as the TC57256AD using an adaptor socket BM1188 and an EPROM programmer.

Part No.	OTP	RAM	Package	Adaptor Socket
TMP87PM78F	32 K × 8-bit	1 K × 8-bit	P-QFP100-1420-0.65A	BM1188

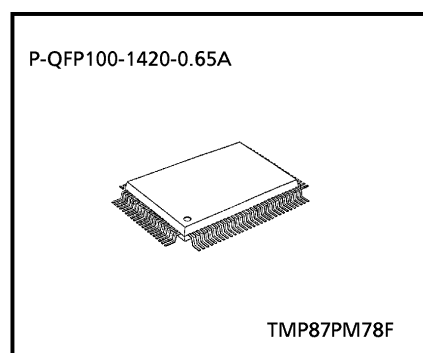

000707EBA1

- For a discussion of how the reliability of microcontrollers can be predicted, please refer to Section 1.3 of the chapter entitled Quality and Reliability Assurance / Handling Precautions.
- TOSHIBA is continually working to improve the quality and reliability of its products. Nevertheless, semiconductor devices in general can malfunction or fail due to their inherent electrical sensitivity and vulnerability to physical stress. It is the responsibility of the buyer, when utilizing TOSHIBA products, to comply with the standards of safety in making a safe design for the entire system, and to avoid situations in which a malfunction or failure of such TOSHIBA products could cause loss of human life, bodily injury or damage to property. In developing your designs, please ensure that TOSHIBA products are used within specified operating ranges as set forth in the most recent TOSHIBA products specifications. Also, please keep in mind the precautions and conditions set forth in the "Handling Guide for Semiconductor Devices," or "TOSHIBA Semiconductor Reliability Handbook" etc..
- The TOSHIBA products listed in this document are intended for usage in general electronics applications (computer, personal equipment, office equipment, measuring equipment, industrial robotics, domestic appliances, etc.). These TOSHIBA products are neither intended nor warranted for usage in equipment that requires extraordinarily high quality and/or reliability or a malfunction or failure of which may cause loss of human life or bodily injury ("Unintended Usage"). Unintended Usage include atomic energy control instruments, airplane or spaceship instruments, transportation instruments, traffic signal instruments, combustion control instruments, medical instruments, all types of safety devices, etc.. Unintended Usage of TOSHIBA products listed in this document shall be made at the customer's own risk.
- The products described in this document are subject to the foreign exchange and foreign trade laws.
- The information contained herein is presented only as a guide for the applications of our products. No responsibility is assumed by TOSHIBA CORPORATION for any infringements of intellectual property or other rights of the third parties which may result from its use. No license is granted by implication or otherwise under any intellectual property or other rights of TOSHIBA CORPORATION or others.
- The information contained herein is subject to change without notice.

Pin Assignments (Top View)

P-QFP100-1420-0.65A

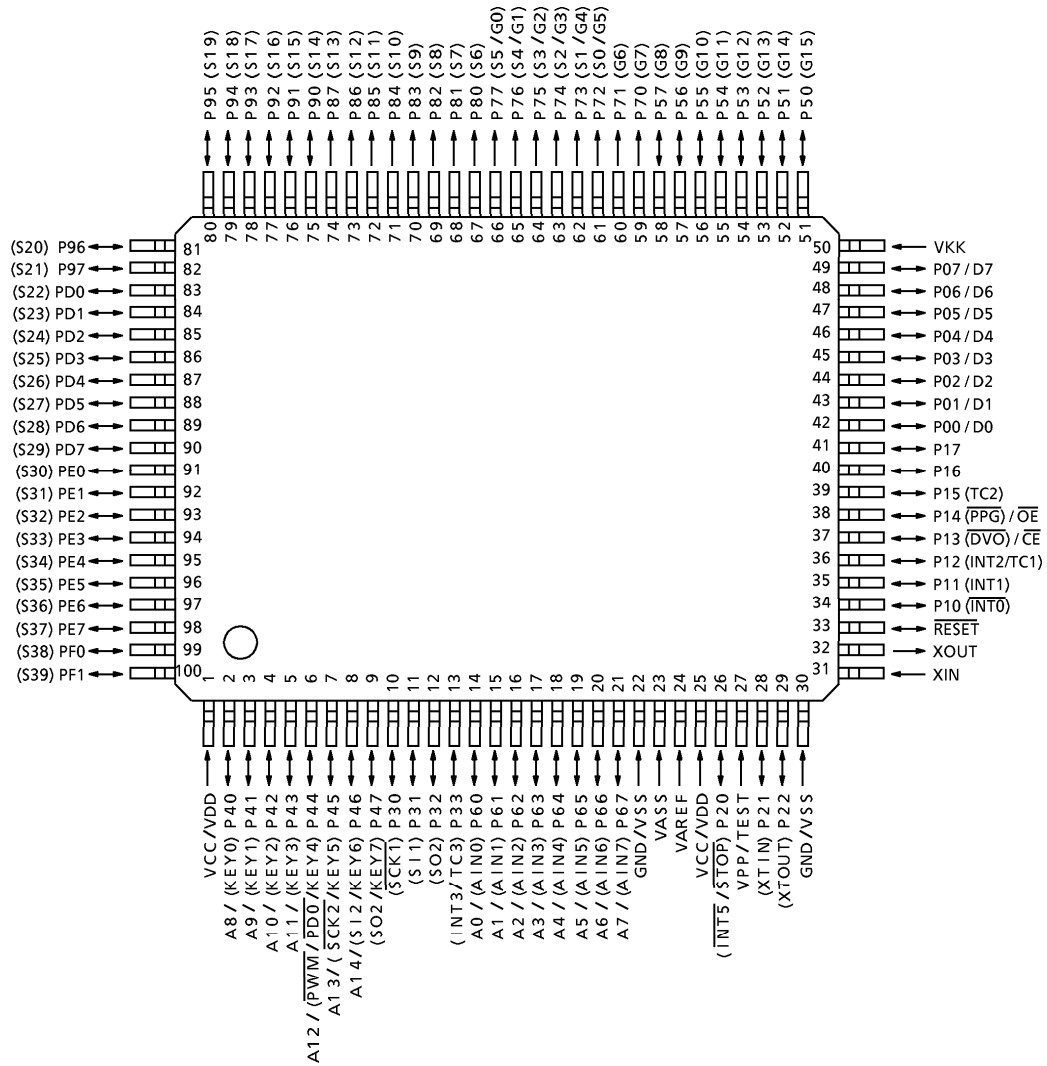

Note: All VDDs should be connected externally for keeping the same voltage level.

Pin Function

The 87PM78 has two modes: MCU and PROM.

(1) MCU mode

In this mode, the 87PM78 is pin compatible with the 87CC78/CH78/CK78/CM78 (fix the TEST pin at low level).

(2) PROM mode

Pin Name (PROM mode)	Input / Output	Functions	Pin Name (MCU mode)
A14 to A8	Input	PROM address inputs	P46 to P40
A7 to A0			P67 to P60
D7 to D0	I/O	PROM data input/outputs	P07 to P00
\overline{CE}	Input	Chip enable signal input (active low)	P13
\overline{OE}		Output enable signal input (active low)	P14
VPP	Power supply	+ 12.5 V / 5 V (Program supply voltage)	TEST
VCC		+ 5 V	VDD
GND		0 V	VSS
P33, P32	I/O	Pull-up with resistance for input processing	
P11, P15			
P21		PROM mode setting pin. Be fixed at high level.	
P47			
P12, P10		PROM mode setting pin. Be fixed at low level.	
P17, P16			
P22, P20			
\overline{RESET}			
XIN	Input	Connect an 8 MHz oscillator to stabilize the internal state.	
XOUT	Output		
VKK	Power supply	GND	
VAREF			
VASS			
PF1 to PF0	I/O	Open	
PE7 to PE0			
PD7 to PD0			
P97 to P90	Output		
P87 to P80			
P77 to P70			
P57 to P50	I/O		

OPERATIONAL DESCRIPTION

The following explains the 87PM78 hardware configuration and operation. The configuration and functions of the 87PM78 are the same as those of the 87CC78/CH78/CK78/CM78, except in that a one-time PROM is used instead of an on-chip mask ROM.

The 87PM78 is placed in the *single-clock* mode during reset. To use the dual-clock mode, the low-frequency oscillator should be turned on by executing [SET (SYSCR2). XTEN] instruction at the beginning of the program.

1. OPERATING MODE

The 87PM78 has two modes: MCU and PROM.

1.1 MCU Mode

The MCU mode is activated by fixing the TEST / VPP pin at low level.

In the MCU mode, operation is the same as with the 87CC78/CH78/CK78/CM78 (the TEST / VPP pin cannot be used open because it has no built-in pull-down resistance).

Electrical Characteristics

Absolute Maximum Ratings

(V_{SS} = 0 V)

Parameter	Symbol	Pins	Ratings	Unit
Supply Voltage	V _{DD}		- 0.3 to 6.5	V
Program Voltage	V _{PP}	TEST / VPP	- 0.3 to 13.0	V
Input Voltage	V _{IN}		- 0.3 to V _{DD} + 0.3	V
Output Voltage	V _{OUT1}	P2, P3, P4, P5, P6, XOUT, $\overline{\text{RESET}}$	- 0.3 to V _{DD} + 0.3	V
	V _{OUT2}	Source open drain ports	V _{DD} - 40 to V _{DD} + 0.3	
Output Current (Per 1 pin)	I _{OUT1}	P0, P1, P2, P3, P4, P5, P6	3.2	mA
	I _{OUT3}	P8, P9, PD, PE, PF	- 12	
	I _{OUT4}	P5, P7	- 25	
	ΣI_{OUT1}	P0, P1, P2, P3, P4, P6	120	
Output Current (Total)	ΣI_{OUT2}	P5, P7, P8, P9, PD, PE, PF	- 120	mA
	PD	Note 2	600	
Power Dissipation [T _{opr} = 25°C]	PD	Note 2	600	mW
Soldering Temperature (time)	T _{sld}		260 (10 s)	°C
Storage Temperature	T _{stg}		- 55 to 125	°C
Operating Temperature	T _{opr}		- 30 to 70	°C

Note 1: The absolute maximum ratings are rated values which must not be exceeded during operation, even for an instant. Any one of the ratings must not be exceeded. If any absolute maximum rating is exceeded, a device may break down or its performance may be degraded, causing it to catch fire or explode resulting in injury to the user. Thus, when designing products which include this device, ensure that no absolute maximum rating value will ever be exceeded.

Note 2: Power Dissipation (PD) ; For PD, it is necessary to decrease 14.3 mW/°C.

Note 3: All VDDs should be connected externally for keeping the same voltage level.

Recommended Operating Conditions

(V_{SS} = 0 V, T_{opr} = - 30 to 70°C)

Parameter	Symbol	Pins	Conditions	Min	Max	Unit	
Supply Voltage	V _{DD}		f _c = 8 MHz	NORMAL 1, 2 modes	4.5	5.5	V
				IDLE 1, 2 modes			
			f _s = 32.768 kHz	SLOW mode	2.7		
				SLEEP mode			
		STOP mode	2.0				
Output Voltage	V _{OUT3}	Source open drain ports		V _{DD} - 38	V _{DD}	V	
Input High Voltage	V _{IH1}	Except hysteresis input	V _{DD} ≥ 4.5 V	V _{DD} × 0.70	V _{DD}	V	
	V _{IH2}	Hysteresis input		V _{DD} × 0.75			
	V _{IH3}		V _{DD} < 4.5 V	V _{DD} × 0.90			
Input Low Voltage	V _{IL1}	Except hysteresis input	V _{DD} ≥ 4.5 V	0	V _{DD} × 0.30	V	
	V _{IL2}	Hysteresis input			V _{DD} × 0.25		
	V _{IL3}		V _{DD} < 4.5 V		V _{DD} × 0.10		
Clock Frequency	f _c	XIN, XOUT	V _{DD} = 4.5 V to 5.5 V	0.4	8.0	MHz	
			V _{DD} = 2.7 V to 5.5 V		4.2		
	f _s	XTIN, XTOUT		30.0	34.0	kHz	

Note 1: The recommended operating conditions for a device are operating conditions under which it can be guaranteed that the device will operate as specified. If the device is used under operating conditions other than the recommended operating conditions (supply voltage, operating temperature range, specified AC/DC values etc.), malfunction may occur. Thus, when designing products which include this device, ensure that the recommended operating conditions for the device are always adhered to.

Note 2: Clock frequency f_c: Supply voltage range is specified in NORMAL 1/2 mode and IDLE 1/2 mode.

D.C. Characteristics

 $(V_{SS} = 0\text{ V}, T_{opr} = -30\text{ to }70^{\circ}\text{C})$

Parameter	Symbol	Pins	Conditions	Min	Typ.	Max	Unit
Hysteresis Voltage	V_{HS}	Hysteresis input		–	0.9	–	V
Input Current	I_{IN1}	TEST	$V_{DD} = 5.5\text{ V}$ $V_{IN} = 5.5\text{ V} / 0\text{ V}$	–	–	± 2	μA
	I_{IN2}	Open drain ports, Tri-state ports					
	I_{IN3}	$\overline{\text{RESET}}, \overline{\text{STOP}}$					
	I_{IN4}	PD, PE, PF ports (Note3)					
Input Resistance	R_{IN1}	Port P4 with pull-down		30	70	150	$\text{k}\Omega$
	R_{IN2}	$\overline{\text{RESET}}$		100	220	450	
Pull-down Resistance	R_K	Source open drain ports	$V_{DD} = 5.5\text{ V}, V_{KK} = -30\text{ V}$	50	80	110	
Output Leakage Current	I_{LO1}	Sink open drain ports	$V_{DD} = 5.5\text{ V}, V_{OUT} = 5.5\text{ V}$	–	–	2	μA
	I_{LO2}	Source open drain ports and tri-state ports	$V_{DD} = 5.5\text{ V}, V_{OUT} = -32\text{ V}$	–	–	–2	
	I_{LO3}	Tri-state ports	$V_{DD} = 5.5\text{ V}, V_{OUT} = 5.5\text{ V} / 0\text{ V}$	–	–	± 2	
Output High Voltage	V_{OH2}	Tri-state ports	$V_{DD} = 4.5\text{ V}, I_{OH} = -0.7\text{ mA}$	4.1	–	–	V
	V_{OH3}	P8, P9, PD, PE, PF	$V_{DD} = 4.5\text{ V}, I_{OH} = -8\text{ mA}$	2.4	–	–	
Output Low Voltage	V_{OL}	Except XOUT	$V_{DD} = 4.5\text{ V}, I_{OL} = 1.6\text{ mA}$	–	–	0.4	V
Output High Current	I_{OH}	P5, P7	$V_{DD} = 4.5\text{ V}, V_{OH} = 2.4\text{ V}$	–	–20	–	mA
Supply Current in NORMAL 1, 2 modes	I_{DD}		$V_{DD} = 5.5\text{ V}$ $f_c = 8\text{ MHz}$ $f_s = 32.768\text{ kHz}$ $V_{IN} = 5.3\text{ V} / 0.2\text{ V}$	–	12	18	mA
Supply Current in IDLE 1, 2 modes				–	6	8	
Supply Current in SLOW mode				–	30	60	μA
Supply Current in SLEEP mode				–	15	30	
Supply Current in STOP mode				$V_{DD} = 5.5\text{ V}$ $V_{IN} = 5.3\text{ V} / 0.2\text{ V}$	–	0.5	

Note 1: Typical values show those at $T_{opr} = 25^{\circ}\text{C}$, $V_{DD} = 5\text{ V}$.

Note 2: Input Current I_{IN1}, I_{IN3} ; The current through resistor is not included, when the input resistor (pull-up/pull-down) is contained.

A/D Conversion Characteristics

 $(V_{SS} = 0\text{ V}, V_{DD} = 4.5\text{ to }5.5\text{ V}, T_{opr} = -30\text{ to }70^{\circ}\text{C})$

Parameter	Symbol	Conditions	Min	Typ.	Max	Unit
Analog Reference Voltage	V_{AREF}	$V_{AREF} - V_{ASS} \geq 2.5\text{ V}$	$V_{DD} - 1.5$	–	V_{DD}	V
	V_{ASS}		V_{SS}	–	1.5	
Analog Reference Voltage Range	ΔV_{AREF}		2.5	–	–	V
Analog Input Voltage	V_{AIN}		V_{ASS}	–	V_{AREF}	V
Analog Supply Current	I_{REF}	$V_{AREF} = 5.5\text{ V}, V_{ASS} = 0.0\text{ V}$	–	0.5	1.0	mA
Nonlinearity Error		$V_{DD} = 5.0\text{ V}, V_{SS} = 0.0\text{ V}$ $V_{AREF} = 5.000\text{ V}$ $V_{ASS} = 0.000\text{ V}$	–	–	± 1	LSB
Zero Point Error			–	–	± 1	
Full Scale Error			–	–	± 1	
Total Error			–	–	± 2	

Note: Quantizing error is not contained in those errors.

A.C. Characteristics

($V_{SS} = 0\text{ V}$, $V_{DD} = 4.5\text{ to }5.5\text{ V}$, $T_{opr} = -30\text{ to }70^\circ\text{C}$)

Parameter	Symbol	Conditions	Min	Typ.	Max	Unit
Machine Cycle Time	t_{cy}	In NORMAL1, 2 modes	0.5	-	10	μs
		In IDLE1, 2 modes				
		In SLOW mode	117.6	-	133.3	
		In SLEEP mode				
High Level Clock Pulse Width	t_{WCH}	For external clock operation (XIN input), $f_c = 8\text{ MHz}$	50	-	-	ns
Low Level Clock Pulse Width	t_{WCL}					
High Level Clock Pulse Width	t_{WSH}	For external clock operation (XTIN input), $f_s = 32.768\text{ kHz}$	14.7	-	-	μs
Low Level Clock Pulse Width	t_{WSL}					

Recommended Oscillating Conditions

($V_{SS} = 0\text{ V}$, $V_{DD} = 4.5\text{ to }5.5\text{ V}$, $T_{opr} = -30\text{ to }70^\circ\text{C}$)

Parameter	Oscillator	Oscillation Frequency	Recommended Oscillator	Recommended Constant	
				C_1	C_2
High-frequency Oscillation	Ceramic Resonator	8 MHz	KYOCERA KBR8.0M	30pF	30pF
		4 MHz	KYOCERA KBR4.0MS MURATA CSA4.00MG		
	Crystal Oscillator	8 MHz	TOYOCOM 210B 8.0000	20pF	20pF
		4 MHz	TOYOCOM 204B 4.0000		
Low-frequency Oscillation	Crystal Oscillator	32.768 kHz	NDK MX-38T	15pF	15pF

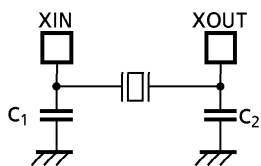

(1) High-frequency Oscillation

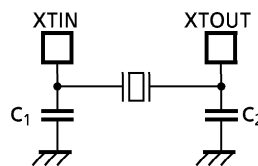

(2) Low-frequency Oscillation

Note: An electrical shield by metal shield plate on the IC package should be recommend able in order to prevent the device from the high electric fieldstress applied for continuous reliable operation.

D.C./A.C. Characteristics (PROM mode) ($V_{SS} = 0\text{ V}$)

(1) Read Operation ($T_{opr} = -30$ to 70°C)

Parameter	Symbol	Conditions	Min	Typ.	Max	Unit
Input High Voltage	V_{IH4}		$V_{CC} \times 0.7$	–	V_{CC}	V
Input Low Voltage	V_{IL4}		0	–	$V_{CC} \times 0.12$	V
Power Supply Voltage	V_{CC}		4.75	5.00	5.25	V
Program Power Supply Voltage	V_{PP}		$V_{CC} - 0.66\text{ V}$	V_{CC}	$V_{CC} + 6.0$	
Address Access Time	t_{ACC}	$V_{CC} = 5.0 \pm 0.5\text{ V}$	–	$1.5t_{cyc} + 300$	–	ns

Note: $t_{cyc} = 500\text{ ns}$ at 8 MHz

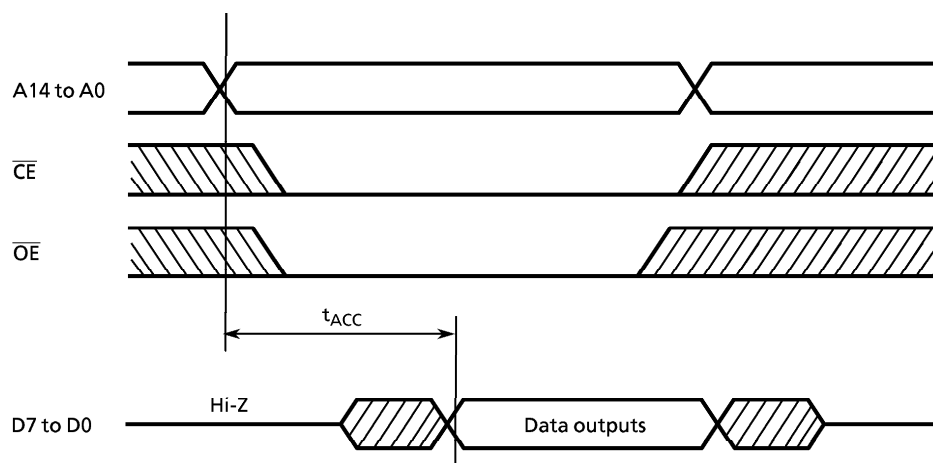

Timing Waveforms of Read Operation

(2) High-Speed Programming Operation (Topr = 25 ± 5°C)

Parameter	Symbol	Conditions	Min	Typ.	Max	Unit
Input High Voltage	V_{IH4}		$V_{CC} \times 0.7$	–	V_{CC}	V
Input Low Voltage	V_{IL4}		0	–	$V_{CC} \times 0.12$	V
Power Supply Voltage	V_{CC}		5.75	6.0	6.25	V
Program Power Supply Voltage	V_{PP}		12.0	12.5	13.0	V
Initial Program Pulse Width	t_{PW}	$V_{CC} = 6.0V \pm 0.25V$ $V_{PP} = 12.5 \pm 0.25V$	0.95	1.0	1.05	ms

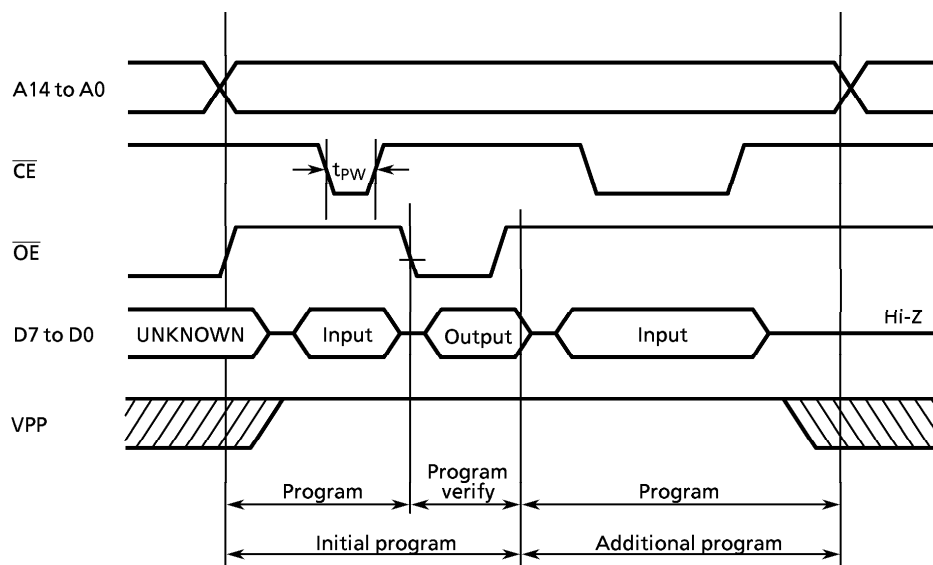

Note 1: When V_{CC} power supply is turned on or after, V_{PP} must be increased.
When V_{CC} power supply is turned off or before, V_{PP} must be decreased.

Note 2: The device must not be set to the EPROM programmer or picked up from it under applying the program voltage ($12.75V \pm 0.5V$) to the V_{PP} pin as the device is damaged.

Note 3: Be sure to execute the recommended programming mode with the recommended programming adaptor. If a mode or an adaptor except the above, the misoperation sometimes occurs.

Timing Waveforms of Programming Operation

(3) Program Operation (High speed write mode - II) ($T_{opr} = 25 \pm 5^{\circ}\text{C}$)

Parameter	Symbol	Conditions	Min	Typ.	Max	Unit
Input High Voltage	V_{IH4}		$V_{CC} \times 0.7$	–	V_{CC}	V
Input Low Voltage	V_{IL4}		0	–	$V_{CC} \times 0.12$	V
Supply Voltage	V_{CC}		6.00	6.25	6.50	V
Program Supply Voltage	V_{PP}		12.50	12.75	13.0	V
Initial Program Pulse Width	t_{PW}	$V_{CC} = 6.25 \text{ V} \pm 0.25 \text{ V}$, $V_{PP} = 12.75 \text{ V} \pm 0.25 \text{ V}$	0.095	0.1	0.105	ms

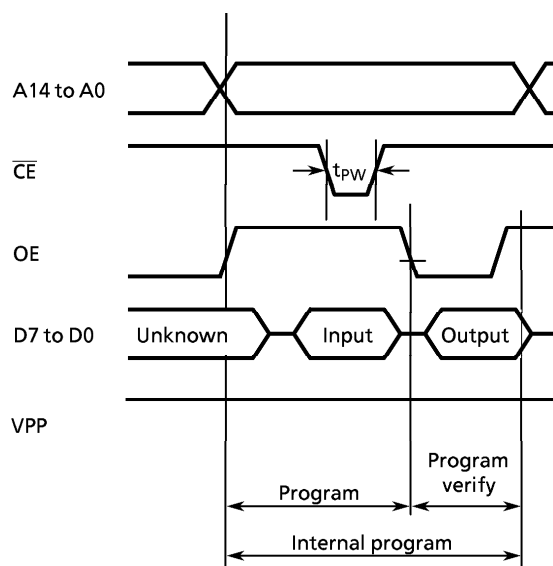

Note 1: When V_{CC} power supply is turned on or after, V_{pp} must be increased.
When V_{CC} power supply is turned off or before, V_{pp} must be decreased.

Note 2: The device must not be set to the EPROM programmer or picked up from it under applying the program voltage ($12.75 \text{ V} \pm 0.5 \text{ V}$) to the V_{pp} pin as the device is damaged.