

**INSTRUCTION MANUAL**  
**DUAL DISPLAY L C R METER**

Model : DE-5000

Thank you for purchasing our products. Please read this instruction manual before using the meter and keep it properly for contingent use.

**DER EE**  
**ELECTRICAL INSTRUMENT CO., LTD.**

7F-2, No.351, Sec. 2, Zhongshan Rd.,  
Zhonghe Dist., New Taipei City 235, Taiwan (R.O.C.)  
TEL:886-2-2226-6789(REP.) FAX:886-2-2226-7979  
E-mail:deree@ms21.hinet.net  
<http://www.deree.com.tw>

**Table of Contents**

I. Introduction.....	03
II. Measuring Principle Introduction.....	04 ~ 07
III. Panel Illustration.....	08 ~ 10
IV. LCD Display Illustration.....	11 ~ 12
V. Operation Instructions.....	13 ~ 34
1. Power ON/OFF .....	13 ~ 14
2. CAL .....	15 ~ 17
3. LCR AUTO .....	18 ~ 20
4. Inductance / Capacitance / Resistance Measurement.....	20 ~ 21
5. FREQ .....	22 ~ 23
6. Backlight .....	23
7. SORTING / SETUP / ENTER .....	23 ~ 25
8. PC .....	26
9. D/Q/ESR/θ .....	27 ~ 28
10. SER/PAL .....	29
11. REL .....	30 ~ 31
12. HOLD .....	32
VI. Replacing Batteries.....	33
VII. General Specification.....	34
VIII. Electrical Specification.....	35 ~36

## Electrical Symbol



Risk of Danger. Important information.  
See Manual.





AC/DC power adaptor input polarity



Current battery capacity indicator

### **Warning**

- Discharge test device before measuring.
- Do not open the case of meter during measurement.
- After measurement, power off the meter. As there will be slight power consumption under auto power off mode.
- Take the batteries out of the meter if it will be left idle for a long time.
- Do not use organic solvent to clean the meter. Wipe it with a soft cloth, if necessary.
-  means battery capacity is full. Once  is displayed which indicates power is low for operation and please replace battery immediately to secure the accuracy in specification.

## I. Introduction

This LCR Meter is a 19999/ 9999 counts dual display, high accuracy LCR meter, which could measure Inductance/ Capacitance/ Resistance with secondary parameters including dissipation factor (D), quality factor (Q), phase angle ( $\theta$ ), equivalent series/ parallel resistance (ESR or  $R_p$ ).

This LCR Meter is fully auto ranging operation for AC impedance & DC resistance measurement. The user could measure the L/C/R components directly in "AUTO-LCR" "smart mode without selecting the function key.

Components could be measured in series or parallel mode according to the DUT (device under test) impedance automatically.

User could select the desired test frequencies of 100Hz/120Hz/1kHz/10kHz /100kHz.

The "SORTING" mode could help the user to make a quick sort for a bunch of components.

The LCD display with the backlight for easy reading in dark places.

With a 9V battery operation is standard for the meter, but a DC 9V adaptor can also be used as an optional power input.

The test data can be transferred to PC through an optional full isolated optical USB-IR interface.

## II. Measuring Principle Introduction

### Impedance parameter introduction

The impedance consists of resistance (real part) and reactance (imaginary part). For example,  $Z_s$  represents the impedance in series mode.  $Z_s$  can be defined a combination of resistance  $R_s$  and reactance  $X_s$ . It also could be defined as a  $|Z|$  ( $|Z| = \sqrt{R_s^2 + X_s^2}$ ) of magnitude with a phase angle  $\theta$ .

Imaginary axis (series mode)

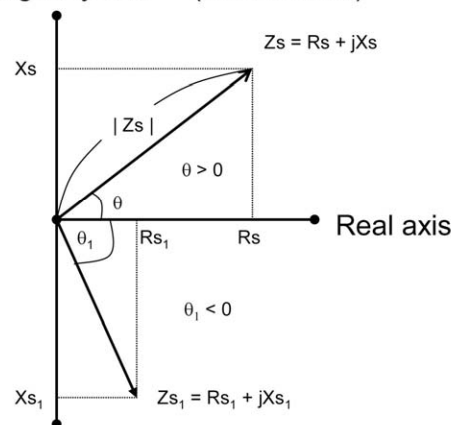

$$Z_s = R_s + jX_s \text{ or } |Z_s| \angle \theta$$

$$R_s = |Z_s| \cos\theta$$

$$X_s = |Z_s| \sin\theta$$

$$X_s/R_s = \tan\theta$$

$$\theta = \tan^{-1}(X_s/R_s)$$

If  $\theta > 0$ , the reactance is inductive. In other words, if  $\theta < 0$ , the reactance is capacitive.

There are two types for reactance. The one is the inductive reactance  $X_L$  and the other is the capacitive reactance  $X_C$ .

They could be defined as:

( $f$  = signal frequency)

$$X_L = 2\pi f L \quad (L = \text{Inductance})$$

$$X_C = 1/(2\pi f C) \quad (C = \text{Capacitance})$$

### Measurement mode

The impedance could be measured in series or parallel mode. The impedance  $Z$  in parallel mode could be represented as reciprocal of admittance  $Y$ . The admittance could be defined as  $Y = G + jB$ . The  $G$  is the conductance and the  $B$  is the susceptance.

Impedance in serial mode

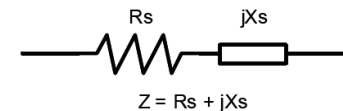

Admittance in parallel mode

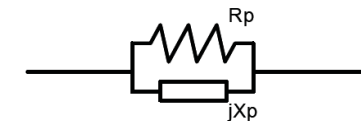

$$Y = 1/Z = 1/R_p + 1/jX_p = G + jB$$

$R_s$ : Resistance in series mode

$X_s$ : Reactance in series mode

$C_s$ : Capacitance in series mode

$L_s$ : Inductance in series mode

$R_p$ : Resistance in parallel mode

$X_p$ : Reactance in parallel mode

$C_p$ : Capacitance in parallel mode

$L_p$ : Inductance in parallel mode

There are two factors to provide the ratio of real part and imaginary part. Usually the quality factor  $Q$  is used for inductance measurement and the dissipation factor  $D$  is used for capacitance measurement.  $D$  factor is defined as a reciprocal of  $Q$  factor.

$$Q = 1 / D = \tan\theta$$

$$Q = X_s / R_s = 2\pi f L_s / R_s = 1 / 2\pi f C_s R_s$$

$$Q = B / G = R_p / |X_p| = R_p / 2\pi f L_p = 2\pi f C_p R_p$$

Actually,  $R_s$  and  $R_p$  are existed in the equivalent circuit of capacitor or inductor. If the capacitor is small,  $R_p$  is more important than  $R_s$ . If capacitor is large, the  $R_s$  is more important also. Therefore, use parallel mode to measure lower value capacitor and use series mode to measure higher value capacitor. For inductor, the impedance relationship is different from capacitor. If the inductor is small,  $R_p$  is almost no effect. If inductor is large, the  $R_s$  is no effect also. Therefore, use series mode to measure lower value inductor and use parallel mode to measure higher value inductor.

### Open/short calibration

process to get the better accuracy for high/low impedance measurement. The purpose of open/short calibration is to reduce the parasitic effect of the test fixture.

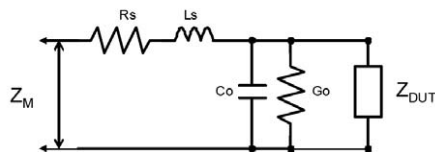

$Z_M$  is defined as total impedance measured to DUT ( device under test ) by the special test fixture which has some parasitic impedance.

$$Z_M = (R_s + j\omega L_s) + ((G_o + j\omega C_o)^{-1} \parallel Z_{DUT})$$

$Z_{DUT}$  is the target impedance user wants to realize. It is necessary to use the open/short calibration process to cancel the effect of  $R_s + j\omega L_s$  and  $G_o + j\omega C_o$ .

### Equivalent circuit

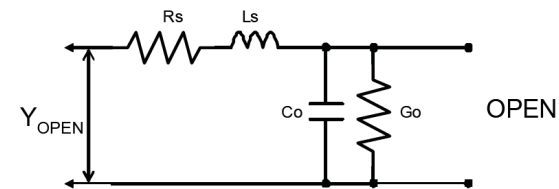
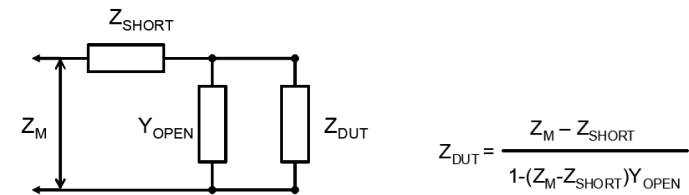

$$\text{If } R_s + j\omega L_s \ll 1 / (G_o + j\omega C_o) \\ Y_{OPEN} = G_o + j\omega C_o$$

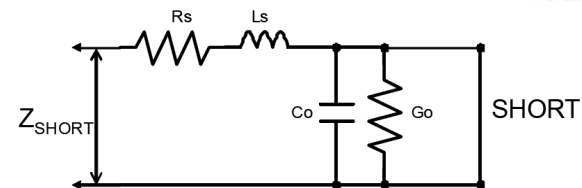

$$Z_{SHORT} = R_s + j\omega L_s$$

## Panel Illustration

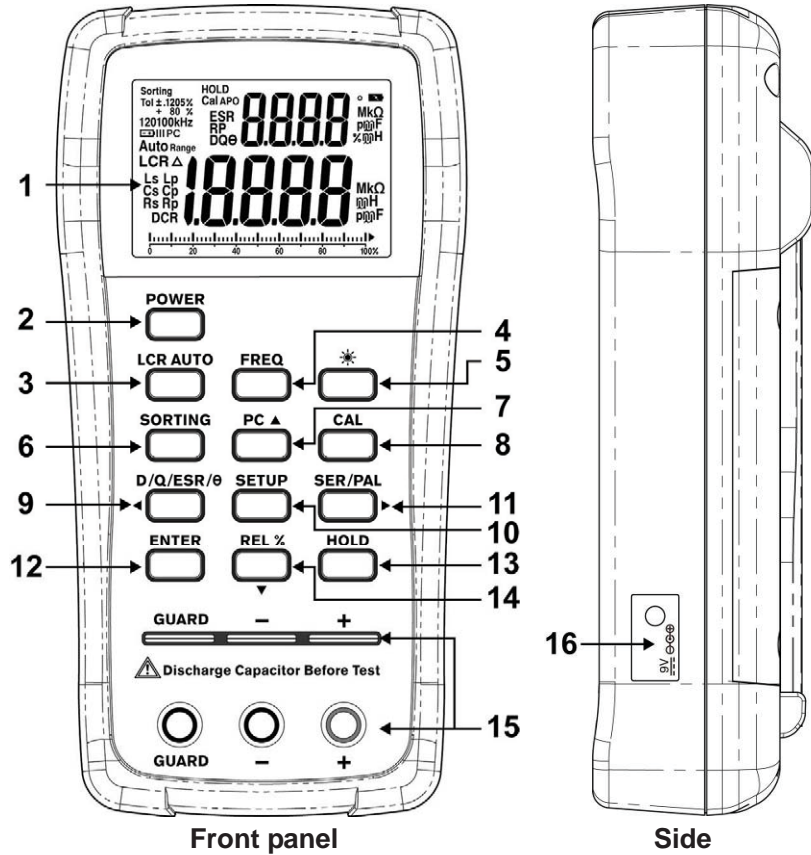

“GUARD” provides shield for DUT ( device under test ), improvised test leads or equipments situated at places where with high interference.

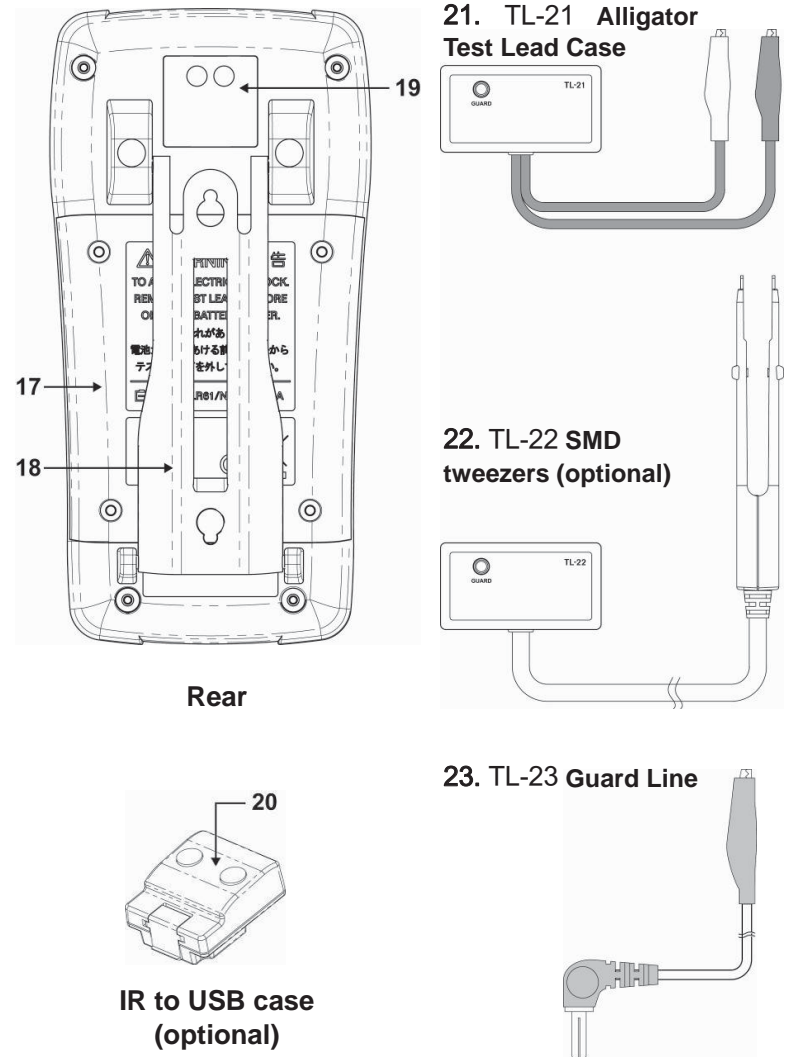

IR to USB case (optional)

1.	<b>LCD display</b>	
2.	<b>POWER</b>	To power on/off the instrument
3.	<b>LCR AUTO</b>	LCR auto mode, Inductance, Capacitance, Resistance and DC resistance measurement selection key
4.	<b>FREQ</b>	Testing frequency selection key
5.		Backlight display
6.	<b>SORTING</b>	Sorting mode control key
7.	<b>PC</b>	UART output control
8.	<b>CAL</b>	Open/Short calibration mode
9.	<b>D/Q/ ESR/θ</b>	D/Q/ ESR/θ parameters selection key
10.	<b>SETUP</b>	Setup menu control key (in sorting mode )
11.	<b>SER/PAL</b>	Series and Parallel selection key
12.	<b>ENTER</b>	Setup menu control key (in sorting mode )
13.	<b>REL%</b>	Relative mode
14.	<b>HOLD</b>	Data hold
15.	<b>Input sockets and Terminals</b>	
16.	<b>AC/DC power adaptor</b>	
17.	<b>Battery cover</b>	
18.	<b>Tilt-Stand</b>	
19.	<b>IR to USB Slot</b>	
20.	<b>IR to USB case (optional)</b>	
21.	<b>TL-21 Alligator Test Lead Case</b>	
22.	<b>TL-22 SMD tweezers (optional)</b>	
23.	<b>TL-23 Guard Line</b>	

### III. LCD Display Illustration

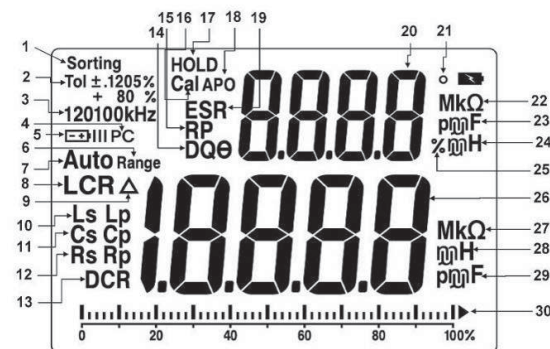

LCD Display.

1.	<b>Sorting</b>	Sorting function is enabled
2.	<b>Tol</b>	Tolerance indication in sorting mode : $\pm 0.25\%$ , $\pm 0.5\%$ , $\pm 1\%$ , $\pm 2\%$ , $\pm 5\%$ , $\pm 10\%$ , $\pm 20\%$ , & $+80\%-20\%$
3.	<b>kHz</b>	Testing frequency indication – 1kHz, 10kHz, 100kHz, 100Hz & 120Hz
4.	<b>PC</b>	Communication is active
5.		Battery capacity indication
6.	<b>Range</b>	Range selection is enabled on setup menu of sorting mode
7.	<b>Auto</b>	Auto range for L, C or R measurement
8.	<b>LCR</b>	Checking for L/C/R mode automatically
9.	<b>Δ</b>	Relative function is enabled
10.	<b>Ls/Lp</b>	Inductance in series or parallel mode is active
11.	<b>Cs/Cp</b>	Capacitance in series or parallel mode is active
12.	<b>Rs/Rp</b>	AC Resistance in series or parallel mode is active
13.	<b>DCR</b>	DC resistance mode is selected

14.	<b>D/Q/θ</b>	Dissipation factor, Quality factor or Phase angle is active for L/C measurement mode
15.	<b>Rp</b>	AC Resistance in parallel mode is active
16.	<b>Cal</b>	Open/Short calibration mode
17.	<b>HOLD</b>	Data Hold
18.	<b>APO</b>	Auto power off mode
19.	<b>ESR</b>	Series equivalent resistance mode
20.	<b>8888</b>	Secondary Display
21.	°	Phase angle unit
22.	<b>MkΩ</b>	Unit for Resistance (Ω, kΩ and MΩ ) – on secondary display
23.	<b>pF</b>	Unit for Capacitance ( pF, nF, μF and mF ) – on secondary display
24.	<b>μH</b>	Unit for Inductance ( μH, mH and H ) – on secondary display
25.	%	The percentage display in relative mode – on secondary display
26.	<b>18888</b>	Primary Display
27.	<b>MkΩ</b>	Unit for Resistance ( Ω, kΩ and MΩ ) – on primary display
28.	<b>μH</b>	Unit for Inductance ( μH,mH and H ) – on primary display
29.	<b>pF</b>	Unit for Capacitance ( pF,nF,μF and mF ) – on primary display
30.		Bar-graph display

- Special Indication Characters

<b>ScT</b>	Indicates short calibration
<b>OPEn</b>	Indicates open calibration

## IV. Operation Instructions

To access optimum precision for all L, C and R measurements especially at the highest and the lowest ranges, please use the alligator test leads (TL-21) or improvised test leads applying to the measurement for OPEN and SHORT calibration (refer to page 15~17) to reduce the parasitic effect of the test fixture before going forward the measurement.

To secure the accuracy in specification, please only connect DUT (device under test) to measuring socket or use TL-21 (standard accessory) or TL-22 (optional accessory) for measurement.

If use improvised test lead for measurement please prevent using long wire which may have incorrect result.

### 1. Power ON/OFF

- When power on, all symbols will display for 2 seconds.

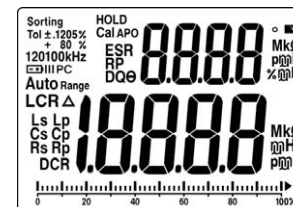

- In Auto Power off mode, APO will be shown on the display. It will power off automatically, if without any key operation or measurement for 5 min. Buzzer will beep three times to remind auto power off is ready to activate and then “OFF” display to power off.



- The default setting is LCR auto mode at test frequency 1kHz.
- Battery condition is detected every second and displayed. suggests battery capacity is full suggests power is low and needs to be replaced a new battery.
- If the key functions, the buzzer beeps once when key is pressed. If the key has no function, the buzzer beeps twice when key is pressed.

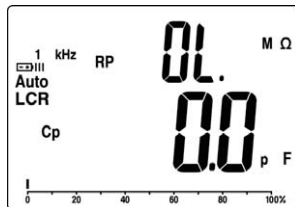

Using adaptor as power supply, Auto Power off function disables automatically and “APO” disappears.

- Auto power off function is disabled automatically, when using a 9V adaptor as the alternative power supply.

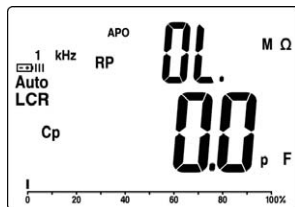

Using 9V- battery as power supply, “APO” displays.

- Auto power off function enables when using a 9V-battery as power supply.

## 2. CAL

- This function enables the LCR meter’s internal parameters and external connector residues to be calibrated to have better and precise measurements.
- To make better precision measurements on extremely high or low impedance ranges of L,C,R, it is highly recommended that do OPEN/SHORT calibration to reduce the parasitic effect of the test fixture before measuring.
- Note: Remove any leads or DUT ( device under test ) from the meter during this procedure. If leaving them connected, will add impedance to the circuit causing the calibration to fail indicated by FAIL showing on the display.

Ex. Operation for open and short calibration with TL-21

Ex. Operation for open and short calibration with .TL-22

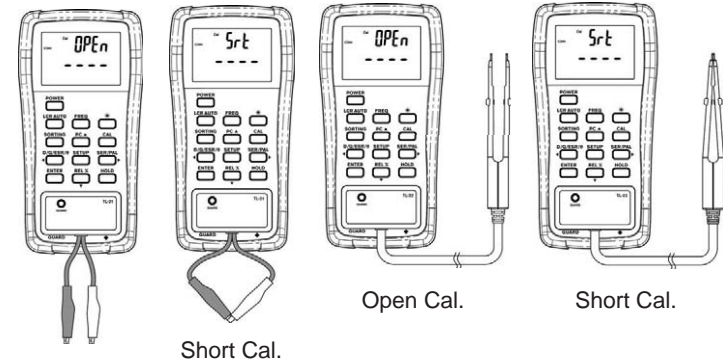

Open Cal.

- Connect TL-21 (or improved test leads applied to the measurements) and press “CAL” key > 2 seconds to enter the calibration mode → OPEN ready → OPEN calibration → SHORT ready → SHORT calibration. Follow below procedure to complete the calibration.
- When start the open or short calibration, it will have 30 seconds countdown shown on the display.



- If calibration is completed, PASS or FAIL appears on the primary display.
- If both calibrations are passed, press "CAL" key again to store the calibration value to EEPROM.(Electrically Erasable Programmable Read-Only Memory).

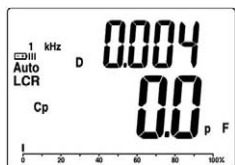

Display the measurement reading

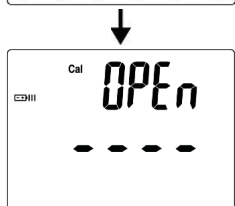

Press "CAL" key for 2sec.

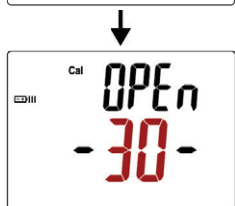

Press "CAL" key

Start the open calibration with 30-seconds countdown



OPEN calibration is completed. Pass or Fail will appear on the primary display  
\* If FAIL, run the procedure from the first step again.

Press "CAL" key

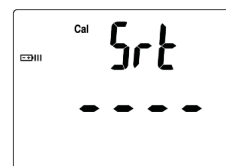

Enter short calibration mode.  
\* Short alligator test leads.

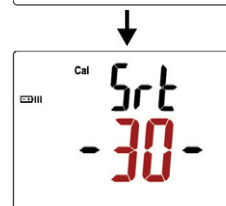

Press "CAL" key

Start the short calibration with 30-seconds countdown

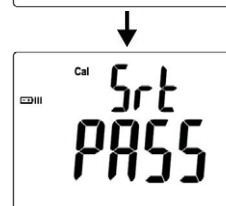

SHORT calibration is completed  
**PASS** or **FAIL** will appear on the primary display  
\* If FAIL, run the procedure from the first step again.

Press "CAL" key

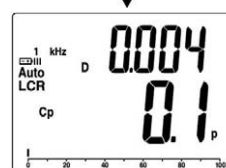

Calibration is completed

Return to testing mode.



When open or short calibration fails. "FAIL" will appear on the primary display.

- If fails in calibration, please double check the DUT( device under test ) is in the right calibration position and resume the open and short calibration procedures.

### 3. LCR AUTO

- The “**LCR AUTO**” key selects the primary parameter measurement function. Each press of the key will select either Auto-LCR mode, Auto-L mode, Auto-C mode, Auto-R mode or Auto-DCR mode<sup>\*1</sup>.
- The default setting is LCR Auto<sup>\*1</sup> mode which can check the type of Impedance smartly and enter to the measurement function automatically.

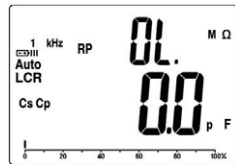

In **LCR AUTO** test mode

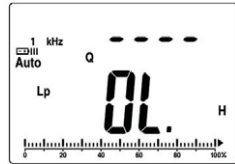

Enter Auto L mode

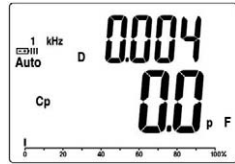

Enter Auto C mode



Press “**LCR AUTO**” key

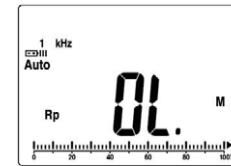

Enter Auto R mode



Press “**LCR AUTO**” key

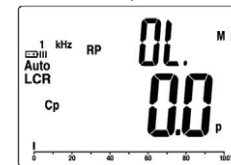

Enter DCR mode

Press “**LCR AUTO**” key

Back to **LCR AUTO** test mode

- When Auto-L or Auto-C mode is selected, the impedance measurement is auto ranging.
- The primary display will show the parameter of inductance, capacitance or resistance of DUT ( device under test ).
- The secondary display will show the quality or dissipation factor of DUT ( device under test ).
- The secondary parameter will be based on the L/C/R measurement. It means that  $(L + Q)$ ,  $(C + D)$ <sup>\*2</sup>,  $(R + \theta)$ <sup>\*3</sup> are combined in one group respectively.

\*1: If  $|Q| < 0.2$ , the Auto-R mode will be selected automatically. The parameter on sub-display is  $\theta$ .  
 If  $Q \geq 0.2$ , the Auto-L mode will be selected automatically. The parameter on sub-display is Q.  
 If  $Q \geq -0.2$ , Auto-C mode will be selected automatically. The parameter on sub-display is D.

If  $C < 5\text{pF}$ . The parameter on sub-display is  $R_p$ .

- \*2: When LCR Auto mode is active, the secondary parameter will show the equivalent resistance in parallel mode ( $R_p$ ) to replace the D factor if the C value of DUT is less than  $5\text{pF}$ .
- \*3: LCR AUTO mode only. In Auto-R mode or DCR mode, the secondary parameter is not available.

#### 4. Inductance / Capacitance / Resistance Measurement

- Power on the meter, the default testing mode is LCR Auto mode that can enter to the L/C/R measurement automatically.
- Each press of the key will select either Auto-LCR mode, Auto-L mode, Auto-C mode, Auto-R mode or Auto-DCR mode.

- a. Insert DIP component leads to the sockets directly. or
- b. To measure DIP and SMD component by **Alligator Test Lead Case (TL-21)**

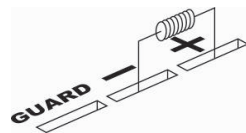

If required, Guard line (TL-23) can provide shield for DUT (device under test ) preventing from interference when measuring high impedance component

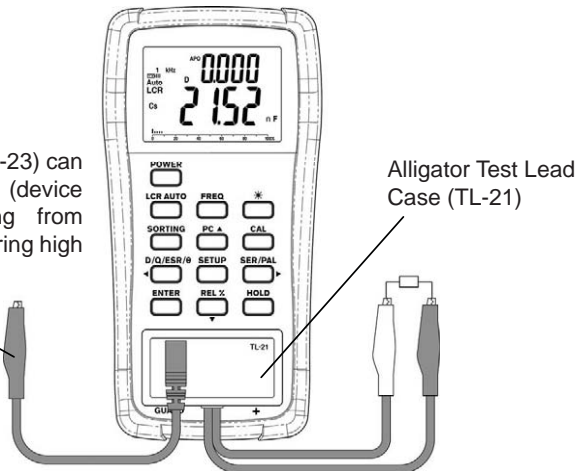

- c. To measure SMD component by SMD tweezers (TL-22, option).

If required, Guard line (TL-23) can provide shield for DUT (device under test ) preventing from interference when measuring high impedance component

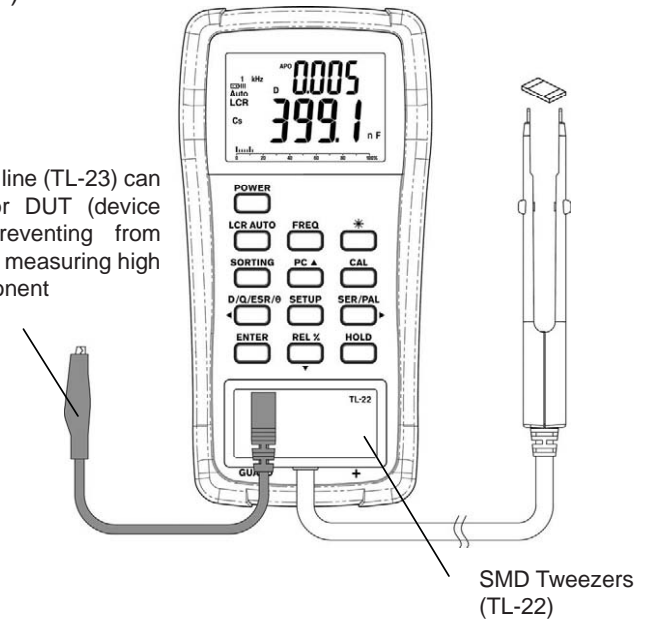

- ※ To make better precision measurements on extremely high or low impedance ranges of L,C,R, it is highly recommended that do OPEN/SHORT calibration before testing.
- Warning : To avoid electric shock, please discharge the capacitor before testing.

## 5. FREQ

- The “**FREQ**” key selects the testing frequency. Each press of the key will select either 1kHz, 10 kHz, 100kHz, 100Hz or 120Hz, total 5 frequency for selection.
- The default frequency setting is 1kHz.



The testing frequency is 1kHz.

Press “**FREQ**” key

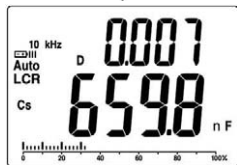

The testing frequency is 10kHz.

Press “**FREQ**” key



The test frequency is 100kHz.

Press “**FREQ**” key



The test frequency is 100Hz.

Press “**FREQ**” key



The test frequency is 120Hz.

Press “**FREQ**” key



Back to test frequency 1 kHz

- The LCR impedance scale ranges are based on the test frequency.

## 6. ⚙ Backlight

- Press “ ⚙ ” key to toggle backlight on/off.
- The backlight will be disabled in 60 seconds automatically from the last operation of pushing any key or measurement.

## 7. SORTING / SETUP / ENTER

- These key functions are disabled in LCR AUTO mode.
- Press “**LCR AUTO**” key to select primary parameter measurement function.
- In measurement (connect DUT), press “**SORTING**” key to enter the sorting mode which will be set to 2000 digits display automatically. If the reading is OL or less than 200 counts, the sorting function is disabled.

- The primary display will show PASS or FAIL which based on whether the impedance measured exceeds tolerance range. The secondary display will show the measurement reading.
- When sorting mode is active, operate “**SETUP**” key along with “◀ / ▶” key, “▲ / ▼” key and “**Enter**” key to set the reference value, range and tolerance.
- When the setup is finished, press “**ENTER**” key to confirm.

Figure : Setting up the reference value for sorting



Display the measurement reading

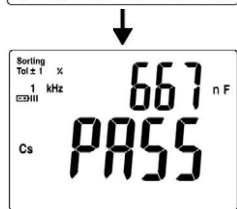

Press “**SORTING**” key

The measurement reading is shown on the secondary display.



Press “**SETUP**” key

“Range” will appear and flash. Push “◀ / ▶” key to select the position of decimal point and units based on the components you measure

Press “**ENTER**” key



Last digit will flash  
Press “◀ / ▶” key to select the desired digit.  
Press “▲ / ▼” key to adjust value.

Press “**ENTER**” key

“Tol ±” will flash.  
Press “◀ / ▶” key to select Tol. value : Each press of the key will select either ±1%, ±2%, ±5%, ±10%, ±20%, -20%+80%, ±0.25% or ±0.5%.

Press “**ENTER**” key

Setup is completed.

- If DUT ( device under test ) is in the specified Tol % , buzzer beeps once and the primary display will show “**PASS**”.

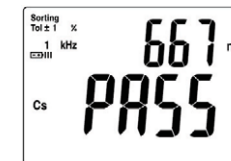

- If DUT ( device under test ) is out of the specified Tol % , the primary display will show “**FAIL**”.

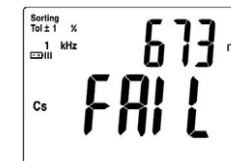

### 8. PC

(IR to USB case is optional. Measuring data can be transferred to PC with it.)

IR to USB case

USB socket

- Snap on IR to USB case and connect with USB cable to PC.
- Press “ PC ” key to start data transmission, and the “PC” will appear on display. Press the “ PC ” key again to cancel the transmission.

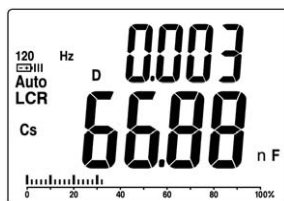
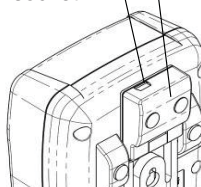

Display the measurement reading

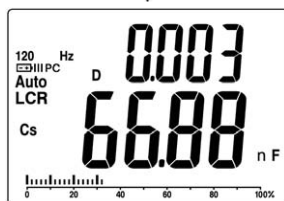

Press “ PC ” key

PC communication is active.  
“PC” will appear on the display

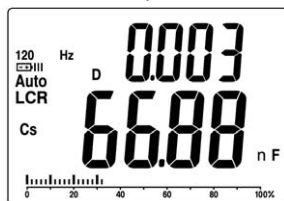

Press “ PC ” key

“PC” disappear on the display  
when PC communication is  
inactive

### 9. D/Q/ESR/θ

- In LCR Auto mode, this key has no function
- The “D/Q/ESR/θ” key selects the secondary parameter measurement function. Each press of the key will select either dissipation (D), quality (Q), ESR or phase angle (θ).

Example : In Cs testing mode

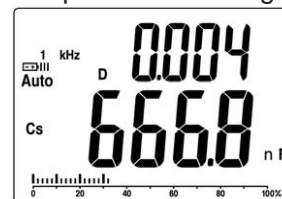

Secondary display parameter is

D.

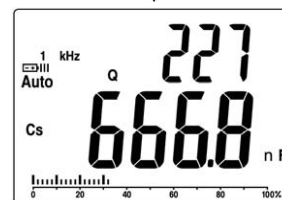

Press “ D/Q/ESR/θ ” key

Secondary display parameter is

Q.

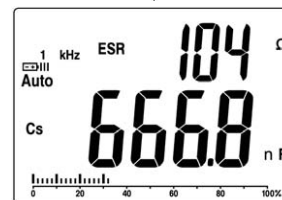

Press “ D/Q/ESR/θ ” key

Secondary display parameter is

ESR.



Press “ D/Q/ESR/θ ” key

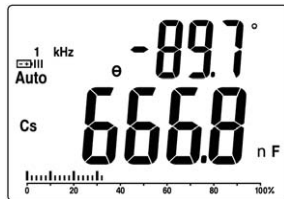

Secondary display parameter is  $\theta$ .

Press “D/Q/ESR/ $\theta$ ” key

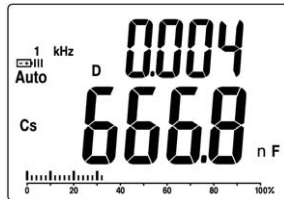

Back to parameter D measurement

- D/Q/ESR/ $\theta$  setting is not applied to resistance measurement- Auto-R mode and DCR mode.

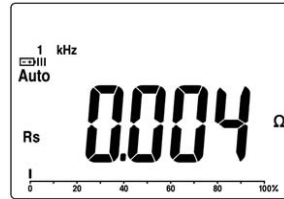

In Auto-R mode, no parameter measurement on the secondary display.

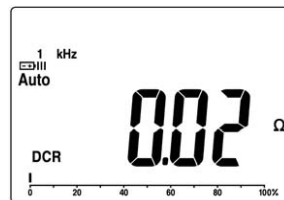

In DCR mode, no parameter measurement on the secondary display.

## 10. SER/PAL

- In LCR Auto mode, this key has no function.
- Press the “SER/PAL” key to select parallel or series mode.
- When any one of primary parameter measurement function is selected, parallel or series mode will be selected automatically based on the total equivalent impedance measured.
- If the impedance is more than 100k $\Omega$ , will be in the parallel mode automatically. Lp, Cp or Rp appears on the display.
- If the impedance is less than 100k $\Omega$ , will be in the series mode automatically. Ls, Cs or Rs appears on the display.

Example : In Cs and Cp testing mode



When measure capacitance in series mode.

“Cs” will appear.

Press “SER/PAL” key



When measure capacitance In Parallel mode.

“Cp” is shown.

Press “SER/PAL” key



Back to Series mode.

“Cs” is shown.

- The annunciators for Ls/Lp/Cs/Cp/Rs/Rp will be indicated based on LCR measurement mode.

## 11.REL

- In LCR Auto mode, this key has no function.
- Press the “REL” key to enter relative mode. The value on the display will be stored as reference value and “Δ” annunciator will appear.
- The secondary display will show the percentage of reference value for all subsequent measurements

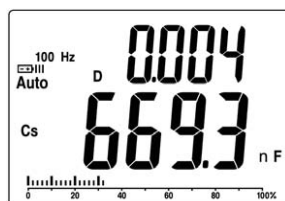

Display the measurement reading  
Ex. 669.3 nF

Press “REL” key

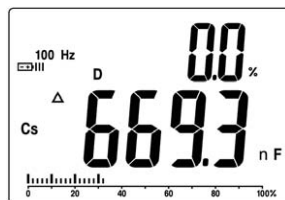

“Δ” appear  
The reading on the display is stored as reference value. 0.0% is shown on the secondary display( since the measured value and the reference are the same at this point )

Remove the current DUT ( device under test ) and insert another one

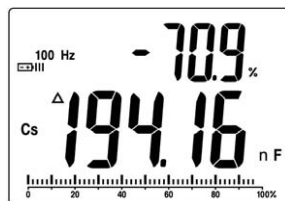

The new reading is shown on the primary display. Minus \*\*\*% is shown on the secondary display.

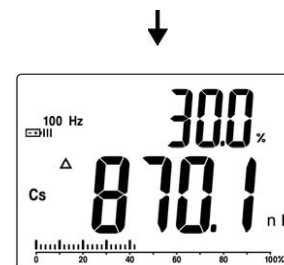

Remove the current DUT ( device under test ) and insert another one

The new reading is shown on the primary display. \*\*\*% is shown on the secondary display. (All subsequent measurements will be displayed as a percentage value to the stored value )



Press “REL” key again

“Δ” flash  
The reference value display on primary display.

- $REL\% = (DCUR - DREF) / DREF * 100\%$

\*DCUR = Current DUT(device under test), DREF = Reference DUT (device under test )

- The percentage range is from -99.9% to 99.9%. When the new measurement is double than reference value. OL% will be shown on the secondary display.
- Press “ REL ” key for more than 2 sec. to exit Relative Mode.



## 12. HOLD

- Press the “**HOLD**” key to freeze the reading on the primary display and “**HOLD**” will appear.
- In the Hold mode, only  key and PC key have function.

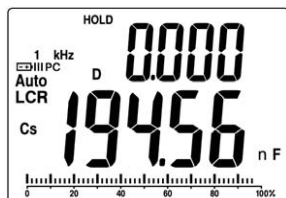

“**HOLD**” is shown.

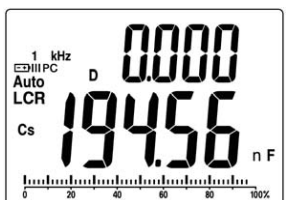

- Press the “**HOLD**” key again, to exit the Hold mode



“**Hold**” disappears

## V. Replacing Batteries

The meter is powered by a single 9V battery, with NEDA1604 , JIS006P and IEC6F22 carbon-zinc or alkaline battery. Alkaline battery is recommended.

When replaces a new battery, the sign of “  ” displays. To ensure the measuring data is within spec, it is suggested to replace battery immediately once “  ” displays.



### **Warning**

- Switch off the meter. Remove all test leads and external adaptor before opening the case.
- Be sure to install the new batteries with correct polarities.

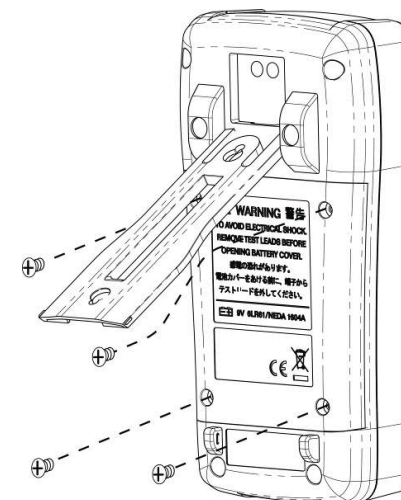
1. Remove tilt-stand.
2. Loosen 4 screws on battery cover with suitable screwdriver.
3. Then take up the cover.
4. Replace the specified battery.
5. Reverse the procedure of step2 and step1.



## VI. General Specification

Item	Dual Display L C R Meter
Parameters Measured	Ls/ Lp/ Cs/ Cp/ Rs/ R p/ D/ Q/ $\Theta$ / ESR L C R auto selection
Measuring Circuit Mode	Series / Parallel mode
Displays	Dual 19999/1999 display
Ranging Mode	Auto
Measuring Terminals	4 - wire Sockets ( Terminals ) & Guard
Auto LCR test range:	L: 20.000 $\mu$ H ~ 2.000 KH C: 200.00pF ~ 20.00mF R: 20.000 $\Omega$ ~ 200.0 M $\Omega$ DCR: 200.00 $\Omega$ ~200.0M $\Omega$
Test Frequency	100Hz/ 120Hz/ 1kHz/ 10kHz/ 100kHz
Backlight	YES
Tolerance mode	$\pm 0.25\%$ , $\pm 0.5\%$ , $\pm 1\%$ , $\pm 2\%$ , $\pm 5\%$ , $\pm 10\%$ , $\pm 20\%$ , $-20\%+80\%$
Test Signal Level	0.5 Vrms Typ.
Measuring Rate	1.2 /second, nominal
Response time	Approx. 1 second/ DUT ( device under test )
Auto Power-Off	5 minutes approx. without key operation
Temperature Coefficient	0.15 x (spec accur.) per $^{\circ}$ C (0-18 $^{\circ}$ C, 28-50 $^{\circ}$ C)
Operation Temperature	0 $^{\circ}$ C to 50 $^{\circ}$ C; 0-70% R.H.
Storage Temperature	-20 $^{\circ}$ C to +60 $^{\circ}$ C; 0-80% R.H.
Battery voltage Indication	When 9V battery in good condition,  displays. When low battery,  displays. Please replace new batteries immediately.
Standard Accessories	Alligator test lead case(TL-21) · AC/DC Adaptor · Guard Line (TL-23) · User manual · DC 9V Battery
Option	IR to USB case · SMD Tweezers(TL-22)
Dimensions (L/W/H)	188 / 95 / 52.5 mm
Weight	approx. 350g (LCR Meter only, excluding battery)

## VII. Electrical Specification

**Accuracy:  $\pm$ (% of reading + number of least significant digits) at 23 $^{\circ}$ C  $\pm$  5 $^{\circ}$ C, <75% R.H.**

- Specifications are based on measurement performed at input sockets or terminals with Alligator Test Lead Case (TL-21) after short & open calibration. (refer to page. 8~10 item 15)
- DUT ( device under test ) & Test leads should be properly shielded to GUARD if necessary.
- To make better precision measurements on extremely high or low impedance ranges of L,C,R, it is highly recommended that do OPEN/SHORT calibration before measuring for following ranges marked with \*

### ■ Resistance (Parallel / Series mode)

Range	Resolution	100/120Hz	1kHz	10kHz	100kHz
20.000 $\Omega$	0.001 $\Omega$	—	1.0%+3*	1.0%+3*	2.0%+3*
200.00 $\Omega$	0.01 $\Omega$	1.0%+3	0.3%+2	0.3%+2	0.6%+3
2.000k $\Omega$	0.0001k $\Omega$	0.3%+2	0.3%+2	0.3%+2	0.6%+3
20.000k $\Omega$	0.001k $\Omega$	0.3%+2	0.3%+2	0.3%+2	0.6%+3
200.00k $\Omega$	0.01k $\Omega$	0.5%+2	0.5%+2	0.5%+2	1.0%+3
2.000M $\Omega$	0.0001M $\Omega$	1.0%+3	1.0%+3	1.0%+3	—
(2.000M $\Omega$ )	0.001M $\Omega$	—	—	—	2.0%+3*
20.000M $\Omega$	0.001M $\Omega$	2.0%+3*	2.0%+3*	—	—
(20.00M $\Omega$ )	0.01M $\Omega$	—	—	2.0%+3*	—
200.0M $\Omega$	0.1M $\Omega$	2.0%+3*	2.0%+3*	—	—

\* Do open/short calibration before measuring for above ranges with \* to have better precision measurements.

### ■ DCR

Range	Resolution	Accuracy
200.00 $\Omega$	0.01 $\Omega$	1.0%+3*
2.000k $\Omega$	0.0001k $\Omega$	0.2%+2
20.000k $\Omega$	0.001k $\Omega$	0.2%+2
200.00k $\Omega$	0.01k $\Omega$	0.5%+2
2.000M $\Omega$	0.0001M $\Omega$	1.0%+3
20.000M $\Omega$	0.001M $\Omega$	2.0%+3*
200.0M $\Omega$	0.1M $\Omega$	2.0%+3*

\* Do open/short calibration before measuring for above ranges with \* to have better precision measurements.

### ■ Capacitance (Parallel / Series mode)

Range	Resolution	100/120Hz	1kHz	10kHz	100kHz
200.00pF	0.01pF	—	—	1.2%+5*	2.0%+5*
2000.0pF	0.1pF	—	2.0%+3*	0.3%+2	0.6%+3
20.000nF	0.001nF	2.0%+3*	0.3%+2	0.3%+2	0.6%+3
200.00nF	0.01nF	0.3%+2	0.3%+2	0.3%+2	0.6%+3
2000.0nF	0.1nF	0.3%+2	0.3%+2	0.6%+2	2.0%+5*
20.000 $\mu$ F	0.001 $\mu$ F	0.3%+2	0.6%+2	1.2%+5*	—
(20.00 $\mu$ F)	0.01 $\mu$ F	—	—	—	3.0%+5 (10 $\mu$ F max.)*
200.00 $\mu$ F	0.01 $\mu$ F	0.6%+2	1.0%+3*	—	—
(200.0 $\mu$ F)	0.1 $\mu$ F	—	—	3.0%+5 (100 $\mu$ F max.)*	—
2000.0 $\mu$ F	0.1 $\mu$ F	1.0%+3*	—	—	—
(2000 $\mu$ F)	1 $\mu$ F	—	1.2%+3*	—	—
20.00mF	0.01mF	1.2%+3*	—	—	—

● If reading <2000, unit on display is pF

\* Do open/short calibration before measuring for above ranges with \* to have better precision measurements.

■ Inductance (Parallel / Series mode).

Range	Resolution	100/120Hz	1kHz	10kHz	100kHz
20.000μH	0.001μH	—	—	—	2.5%+5*
200.00μH	0.01μH	—	—	1.2%+5*	0.6%+3
2000.0μH	0.1μH	—	2.0%+5*	0.6%+3	0.6%+3
20.000mH	0.001mH	1.2%+5*	1.0%+5	0.3%+2	0.6%+3
200.00mH	0.01mH	0.3%+2	0.6%+3	0.3%+2	1.2%+5*
2000.0mH	0.1mH	0.3%+2	0.3%+2	0.6%+3	—
20.000H	0.001H	0.3%+2	0.6%+3	1.2%+5*	—
200.0H	0.1H	0.6%+3	1.2%+5*	—	—
2.000KH	0.001KH	1.2%+5*	—	—	—

● If reading <2000, unit on display is μH

\* Do open/short calibration before measuring for above ranges with \* to have better precision measurements.

■ Accuracy v.s. Resistance (ZDUT)

	DCR	100/120Hz	1kHz	10kHz	100kHz
0.1~1Ω	1.2%+5*	1.2%+5*	1.2%+5*	1.2%+5*	2.5%+5*
1~10Ω	0.6%+3*	0.6%+3*	0.6%+3*	0.6%+3*	1.2%+5*
10~100kΩ	0.3%+2	0.3%+2	0.3%+2	0.3%+2	0.6%+3
100k~1MΩ	0.6%+3	0.6%+3	0.6%+3	0.6%+3	2.5%+5*
1M~20MΩ	1.2%+5*	1.2%+5*	1.2%+5*	2.5%+5*	100k~2MΩ
>20MΩ	2.5%+5*	2.5%+5*	2.5%+5*	—	—

\* Do open/short calibration before measuring for above ranges with \* to have better precision measurements.

If  $D > 0.1$ , the accuracy should be multiplied by  $\sqrt{1+D^2}$

If  $D \ll 0.1$  in capacitance mode  $ZC = 1/2\pi fC$

If  $D \ll 0.1$  in inductance mode  $ZL = 2\pi fL$

Sub-display parameters accuracy

Ae = impedance (Z) accuracy

Definition:  $Q = 1/D$  &  $Rp = ESR * (1+1/D^2)$

D value accuracy  $De = \pm Ae * (1+D)$

ESR accuracy  $Re = \pm ZM * Ae (\Omega)$

ie., ZM = impedance calculated by  $1/2\pi f C$  or  $2\pi f L$

Phase angle  $\theta$  accuracy  $\theta e = \pm (180/\pi) * Ae$  (deg)

Appearance and specification may be revised if needed without prior notice.

DER EE is assessed and certificated as meeting the requirements of ISO 9001:2000. We produce meters in various types and specification and all our product conforms to ISO standards. If any further inquiry needed, please visit our website at [www.deree.com.tw](http://www.deree.com.tw)