

AM/FM STEREO TUNER

KT-6050

SERVICE MANUAL

KENWOOD

B51-4771-00 (S) 2318

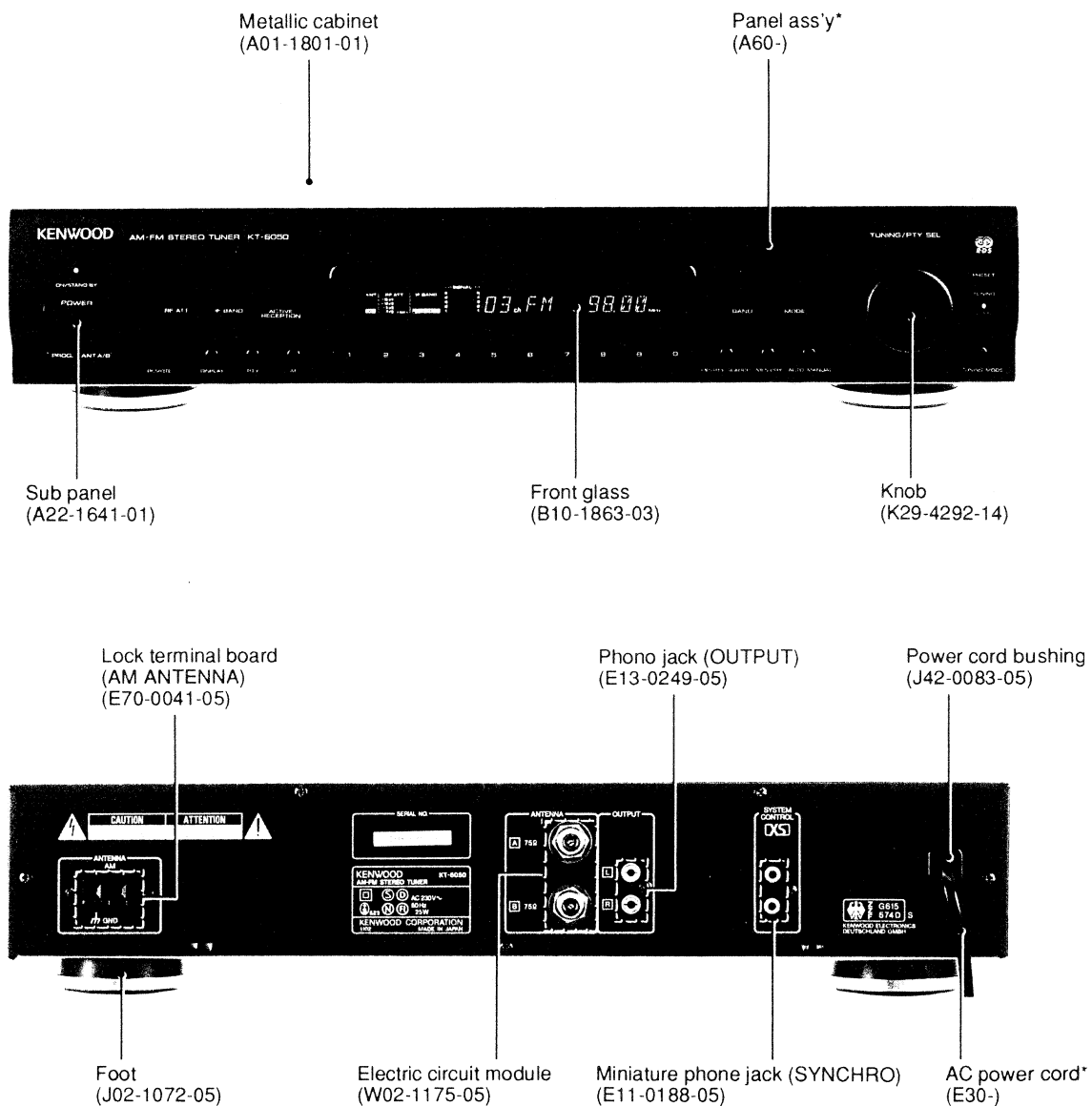











* Refer to parts list on page 28.

CONTENTS/ACCESSORIES

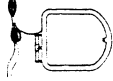
CIRCUIT DESCRIPTION.....	4	PC BOARD	15
ADJUSTMENT	10	SCHEMATIC DIAGRAM	19
REGLAGE	11	EXPLODED VIEW	27
ABGLEICH	12	PARTS LIST	28
WIRING DIAGRAM	13	SPECIFICATIONS	BACK COVER

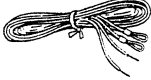
Accessories

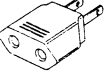
Remote controller assy.....1 (A70-0940-05) 	Loop antenna stand	1 (J19-2815-04) 	Audio cord.....1 (E30-0505-05) 
Battery cover (A09-0146-08) 	Batteries	2 	Antenna adaptor.....1 (T90-0185-05) 
AM loop antenna.....1 (T90-0173-05) 	Antenna adaptor.....1 (T90-0185-05) 	FM indoor antenna.....1 (T90-0176-05) 	System control cord.....1 (E30-2733-05) 
	AC plug adaptor.....1 (E03-0115-05): M ONLY 		

REMOTE CONTROL OPERATION

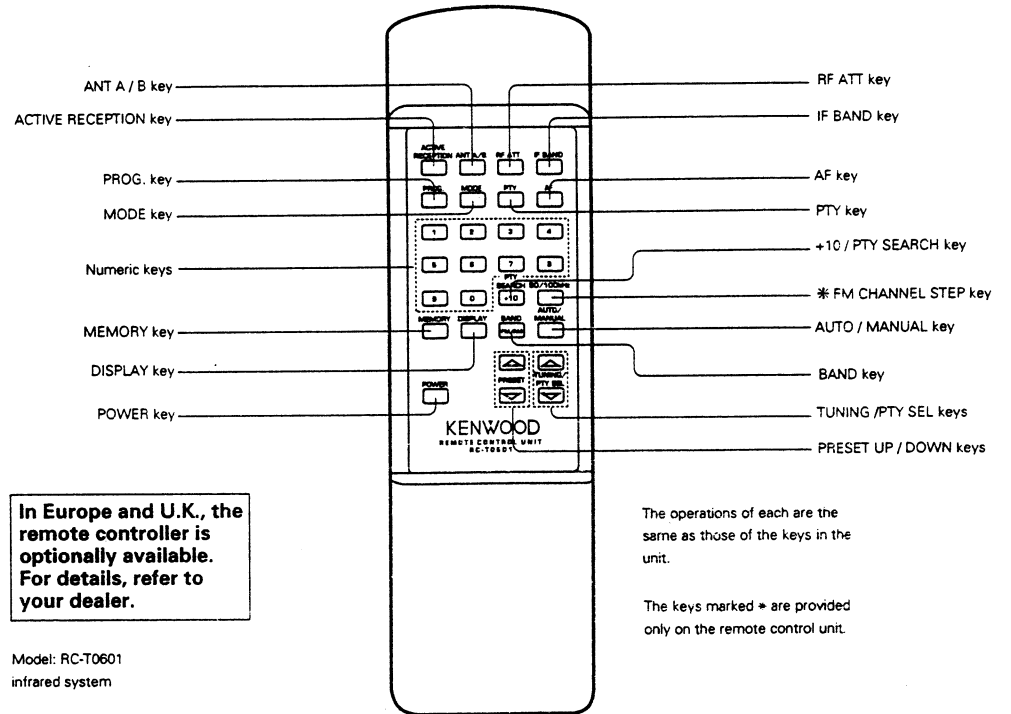

CIRCUIT DESCRIPTION

MICROPROCESSOR (μ PD78044GF-043)(IC1: X13)

Pin Function

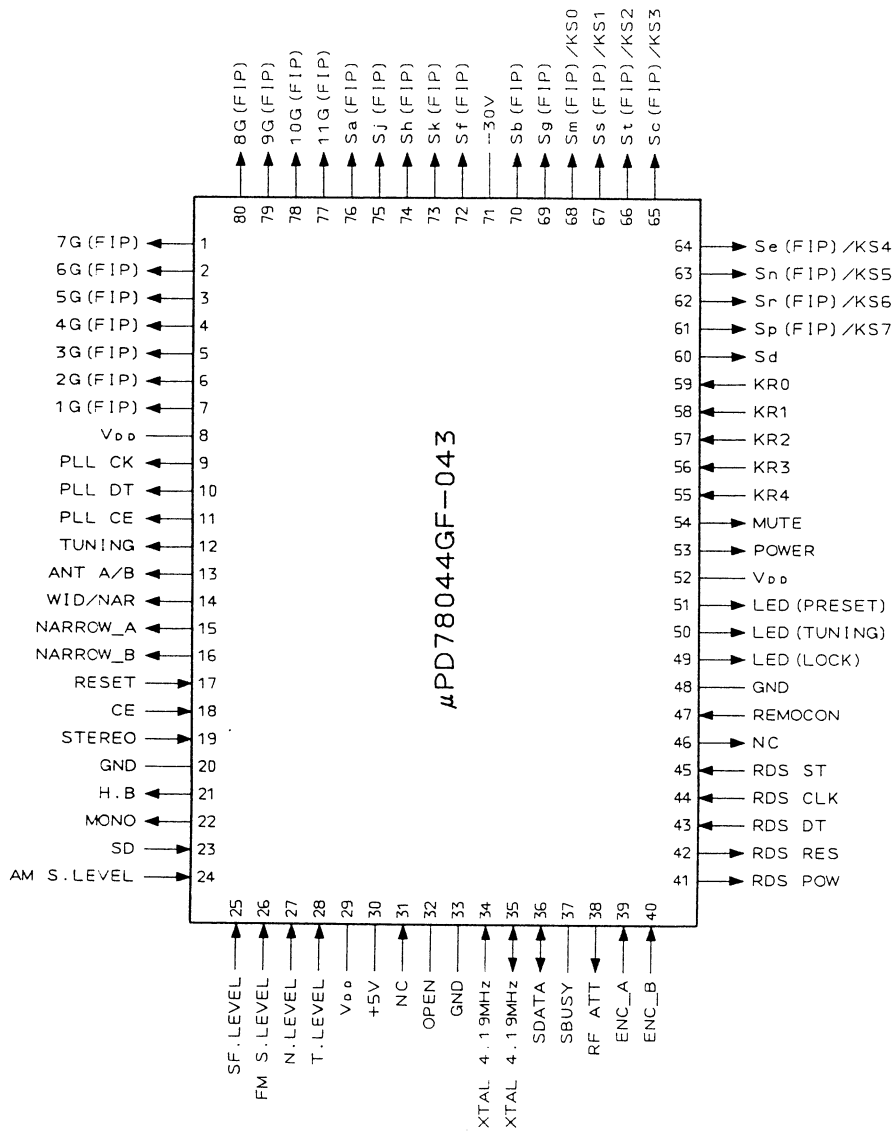

CIRCUIT DESCRIPTION

Pin Description

No.	Pin Name	Name	I/O	Description
1	P94/FIP6	7G	O	FL grid
2	P93/FIP5	6G	O	FL grid
3	P92/FIP4	5G	O	FL grid
4	P91/FIP3	4G	O	FL grid
5	P90/FIP2	3G	O	FL grid
6	P81/FIP1	2G	O	FL grid
7	P80/FIP0	1G	O	FL grid
8	VDD	VDD	-	Power supply for microcomputer
9	P27/SCK0	PLLCK	O	PLL IC CLOCK
10	P26/SO0/SB1	PLLDT	O	PLL IC DATA
11	P25/SI0/SB0	PLLCE	O	PLL IC CE
12	P24/BUSY	TUNING	O	TUNING port
13	P23/STB	ANT A/B	O	ANT A/B control H:ANT B L:ANT A
14	P22/SCK1	WID/NAR	O	IF BAND control H:NARROW L:WIDE
15	P21/SO1	NARROW A	O	Notch filter control H:ON L:OFF
16	P20/SI1	NARROW B	O	Notch filter control H:ON L:OFF
17	RESET	RESET	I	Microcomputer reset
18	P74	CE	I	Microcomputer CE
19	P73	STEREO	I	STEREO detection H:MONO L:STEREO
20	AVSS	GND	-	A/D Power supply
21	P17/ANI7	H.B	O	HI-BLEND play H:HI-BLEND ON L:HI-BLEND OFF
22	P16/ANI6	MONO	O	Forced MONO play H:MONO L:AUTO STEREO
23	P15/ANI5	SD	I	SD (tuned) detection H:not tuned L:tuned
24	P14/ANI4	AM S. LEVEL	I	AM Signal level(A/D input)
25	P13/ANI3	SF. LEVEL	I	High-speed signal level (A/D input)
26	P12/ANI2	FM S. LEVEL	I	FM Signal level (A/D input)
27	P11/ANI1	N. LEVEL	I	Noise level (A/D input)
28	P10/ANI0	T. LEVEL	I	T Meter level (A/D input)
29	AVDD	VDD	-	A/D Power supply
30	AVREF	+5 V	-	A/D Reference power supply
31	P04/XT1	Not used.	I	
32	XT2	OPEN	-	
33	VSS	GND	-	A/D Power supply
34	X1	OSC	I	4.19 MHz oscillator
35	X2	OSC	O	4.19 MHz oscillator
36	P37	SDATA	I/O	8 bit Serial communication DATA terminal
37	P36/BUZ	SBUSY	I/O	8 bit Serial communication BUSY terminal
38	P35/PCL	RF ATT	O	RF ATT control (PWM output)
39	P34/TI2	ENC A	I	Rotary encoder input A
40	P33/TI1	ENC B	I	Rotary encoder input B
41	P32/TO2	RDS POW	O	RDS POWER terminal H:RDS POWER OFF L:RDS POWER ON

CIRCUIT DESCRIPTION

No.	Pin Name	Name	I/O	Description
42	P31/TO1	RDS RES	O	RDS RESET
43	P30/TO0	RDS DT	I	RDS DATA
44	P03/INTP3/CI0	RDS CLK	I	RDS CLOCK
45	P02/INTP2	RDS ST	I	RDS START
46	P01/INTP1	Not used.	O	
47	P00/INTP0/TI0	REMOCON	I	Remote control input
48	IC	GND	-	(Power supply)
49	P72	LED (LOCK)	O	LED display H:LED OFF L:LED ON
50	P71	LED (TUNING)	O	LED display H:LED OFF L:LED ON
51	P70	LED (PRESET)	O	LED display H:LED OFF L:LED ON
52	Vdd	Vdd	-	Microcomputer power supply
53	P127/FIP33	POWER	O	POWER H:POWER ON L:POWER OFF
54	P126/FIP32	MUTE	O	MUTE H:MUTE OFF L:MUTE ON
55	P125/FIP31	KR4	I	Key return
56	P124/FIP30	KR3	I	Key return
57	P123/FIP29	KR2	I	Key return
58	P122/FIP28	KR1	I	Key return
59	P121/FIP27	KR0	I	Key return
60	P120/FIP26	Sd	O	FL segment
61	P117/FIP25	Sp/KS7	O	FL segment/Key scan
62	P116/FIP24	Sr/KS6	O	FL segment/Key scan
63	P115/FIP23	Sn/KS5	O	FL segment/Key scan
64	P114/FIP22	Se/KS4	O	FL segment/Key scan
65	P113/FIP21	Sc/KS3	O	FL segment/Key scan
66	P112/FIP20	Sr/KS2	O	FL segment/Key scan
67	P111/FIP19	Ss/KS1	O	FL segment/Key scan
68	P110/FIP18	Sm/KS0	O	FL segment/Key scan
69	P107/FIP17	Sg	O	FL segment
70	P106/FIP16	Sb	O	FL segment
71	VLOAD	-30 V	-	FL drive power supply
72	P105/FIP15	Sf	O	FL segment
73	P104/FIP14	Sk	O	FL segment
74	P103/FIP13	Sh	O	FL segment
75	P102/FIP12	Sj	O	FL segment
76	P101/FIP11	Sa	O	FL segment
77	P100/FIP10	11G	O	FL grid
78	P97/FIP9	10G	O	FL grid
79	P96/FIP8	9G	O	FL grid
80	P95/FIP7	8G	O	FL grid

CIRCUIT DESCRIPTION

TEST MODE

1. Initial Condition

- Setting method

Plugging in the AC power while holding down the MEMORY key initializes this unit.

MODE	STATUS
POWER	OFF
Program operation mode	OFF
Last band	FM
Last FM frequency	Japan: 76.0 MHz/Other: 87.5 MHz
Last AM frequency	Ch Space 9 kHz: 531 kHz/ Ch Space 10 kHz: 530 kHz
Last P. CH	— ch
P. CH memory	Manufacturer's memory settings (Test frequency)
Tuning mode	AUTO
Active preception	OFF
ANT A/B	A
RF ATT	0 dB
IF BAND	WIDE
MONO/ST	AUTO STEREO
Encoder mode	Tuning

2. Test Mode

1-1. This unit test mode

- Setting method

While holding down the Tuning mode key, plug in the AC power.

- Canceling method

Unplug the AC power, then plug it in again.

- Contents

(1) Starting test mode for this unit

If you plug in the AC power while holding down the Tuning mode key, pressing a key on this unit puts it into test mode. Three functions are carried out.

- Automatic power on
- Fluorescent display tube and LEDs all light up.
- Initialization of all states except power on/off pressing any key on this unit ends the all-display-lit state. States changed during test mode are initialized by ending test mode for this unit (unplugging, then plugging in the AC power).

(2) 0-9, +10 test mode operation

- When the +10 key is not pressed, Channels 1-9 (1-9 keys) and Channel 10 (0 key) can be called out.
- When the +10 key is pressed once, Channels 11-19 (1-9 keys) and Channel 20 (0 key) can be called out.
- When the +10 key is pressed twice, Channels 21-29 (1-9 keys) and Channel 30 (0 key) can be called out.
- When the +10 key is pressed three times, Channels 31-39 (1-9 keys) can be called out. Pressing the 0 key calls out Channel 10 and returns this unit to the status it has in a) when the +10 key has not been pressed.
- When the +10 key is pressed four times, this unit returns to the status it has when the +10 key has not been pressed.

(3) RF ATT test mode operation

Normally, the RF attenuation control cycles the attenuation through 0 dB, -5 dB, and -15 dB with the RF key. In test mode, you can cycle through seven settings with the RF key: 0 dB, -2.5 dB, -5 dB, -7.5 dB, -10 dB, -12.5 dB, and -15 dB. These are the controllable RF attenuation values for active reception. Finer control is not possible.

ADJUSTMENT

No.	ITEM	INPUT SETTINGS	OUTPUT SETTINGS	TUNER SETTINGS	ALIGNMENT POINTS	ALIGN FOR	FIG.
FM SECTION SELECTOR: FM							
1	V _T	—	Connect a DC voltmeter between TP6(V _T) and TP7(GND).	87.5 MHz	L42	3.0 V±0.1 V	
2	V _T	—	Connect a DC voltmeter between TP6(V _T) and TP7(GND).	108 MHz	TC1	25.0 V ±0.2 V	
3	DETECTOR (PLL)	98 MHz Dev. 75 kHz → OFF ANT input 120 dBμ	Connect a DC voltmeter between TP4(DET) and TP5(GND).	98 MHz	L37	Rotate the core, and set to Dev OFF after having checked the output at Dev 0. 0.000V ± 15 mV	
4	DETECTOR (Quadrature)	98 MHz Dev. 75 kHz → OFF ANT input 120 dBμ	Connect a DC voltmeter between TP1(TUNED) and TP2(Vref).	98 MHz	L35	Rotate the core, and set to Dev OFF after having checked the output at Dev 0. 0.00V ± 30mV	
5	SENSITIVITY	98 MHz AF 1 kHz± 75 kHz dev	—	98 MHz	L6, L7, L9, L11, L15	Output waveform at maximum and optimum status.	
6	AUTO-STOP SENSITIVITY	14 dBμ (ANT)	—	98 MHz	VR1	S meter No.1 lights. Digital display: 14 dBμ ± 0 dBμ	
7	AUTO-STOP SENSITIVITY	70 dBμ (ANT)	—	98 MHz	VR17	Five S meter lights. Digital display: 70 dBμ ± 1 dBμ	
8	DISTORTION (MONO)	MONO	Connect a distortion meter to output jack.	IF: WIDE	VR5 VR6 VR9	Minimum distortion.	
9	DISTORTION (MONO)	MONO		IF: NARROW	VR4 VR7		
10	DISTORTION (STEREO)	L/R	Connect a distortion meter to output jack.	IF: WIDE	VR12	Minimum distortion.	
11	DISTORTION (STEREO)	SUB		IF: WIDE	VR8		
12	DISTORTION (STEREO)	L/R		IF: NARROW	VR11		
13	DISTORTION (STEREO)	SUB		IF: NARROW	VR10		
14	PILOT CANCEL	98 MHz PILOT±6.75 kHz dev 80 dBμ input	Connect a DC voltmeter between TP9(PG) and GND	—	VR16	Adjust the level of 19 kHz to minimum.	
15	SEPARATION	L/R 80 dBμ(ANT)	—	IF: WIDE	VR14(L) VR15(R)	Optimum separation.	
16	SEPARATION	L/R 80 dBμ(ANT)	—	IF: NARROW	VR13	Optimum separation.	
AM SECTION SELECTOR: AM(MW)							
(1)	AM AUTO-STOP	DIRECT input 28 dBμ (400Hz)	—	999 kHz	VR2	S meter No.1 lights.	

REGLAGE

ABGLEICH

N°	ITEM	REGLAGE DE L'ENTREE	REGLAGE DE LA SORTIE	REGLAGE DU TUNER	POINT DE L'ALIGNEMENT	ALIGNER POUR	FIG.
SECTION MF SELECTEUR: FM							
1	V _T	—	Relier un voltmètre CC entre les TP6(V _T) et TP7(GND).	87.5 MHz	L42	3,0 V ± 0,1 V	
2	V _T	—	Relier un voltmètre CC entre les TP6(V _T) et TP7(GND).	108 MHz	TC1	25,0 V ± 0,2 V	
3	DETEKTOR (PLL)	98 MHz Dév. 75 kHz → ARRET Entrée ANT 120 dBμ	Relier un voltmètre CC entre les TP4(DET) et TP5(GND).	98 MHz	L37	Tourner le tore et régler sur Dev ARRET après avoir vérifié la sortie à Dev 0. 0,000V ± 15 mV	
4	DETEKTOR (Quadrature)	98 MHz Dév. 75 kHz → ARRET Entrée ANT 120 dBμ	Relier un voltmètre CC entre les TP1(TUNED) et TP2(Vref).	98 MHz	L35	Tourner le tore et régler sur Dev ARRET après avoir vérifié la sortie à Dev 0. 0,00V ± 30mV	
5	SENSIBILITÉ	98 MHz AF 1 kHz ± 75 kHz dév	—	98 MHz	L6, L7, L9, L11, L15	Onde de sortie à l'état maximum et optimum.	
6	SENSIBILITÉ ARRÊT AUTOMATIQUE	14 dBμ (ANT)	—	98 MHz	VR1	Le S-mètre No. 1 s'allume. Affichage numérique: 14 dBμ ± 0 dBμ	
7	SENSIBILITÉ ARRÊT AUTOMATIQUE	70 dBμ (ANT)	—	98 MHz	VR17	Cinq S-mètres s'allume. Affichage numérique: 70 dBμ ± 1 dBμ	
8	DISTORSION (MONO)	MONO	Brancher un distorsiomètre sur la prise de sortie.	IF: LARGE	VR5 VR6 VR9	Distorsion minimale.	
9	DISTORSION (MONO)	MONO		IF: ETROIT	VR4 VR7		
10	DISTORSION (STEREO)	L/R	Brancher un distorsiomètre sur la prise de sortie.	IF: LARGE	VR12	Distorsion minimale.	
11	DISTORSION (STEREO)	SUB		IF: LARGE	VR8		
12	DISTORSION (STEREO)	L/R		IF: ETROIT	VR11		
13	DISTORSION (STEREO)	SUB		IF: ETROIT	VR10		
14	PILOT CANCEL	98 MHz Signal pilote ± 6,75 kHz dév Entrée 80 dBμ	Relier un voltmètre CC entre les TP9(PG) et GND.	—	VR16	Réglr le niveau de 19 kHz au minimum.	
15	SÉPARATION	L/R 80 dBμ(ANT)	—	IF: LARGE	VR14(L) VR15(R)	Séparation optimale.	
16	SÉPARATION	L/R 80 dBμ(ANT)	—	IF: ETROIT	VR13	Séparation optimale.	
SECTION MA SELECTEUR: AM(MW)							
(1)	SENSIBILITÉ DE L'ARRÊT AUTOMATIQUE AM	Entrée DIRECTE 28 dBμ (400Hz)	—	999 kHz	VR2	Le S-mètre No. 1 s'allume.	

NR.	GEGENSTAND	EINGANGS-EINSTELLUNG	AUSGANGS-EINSTELLUNG	TUNER-EINSTELLUNG	ABGLEICH-PUNKTE	ABGLEICHEN FÜR	ABB.
UKW-EMPfangSABTEILUNG WÄHLER: FM							
1	V _T	—	Einen Gleichspannungsmesser zwischen TP6(V _T) und TP7(GND) anschließen.	87,5 MHz	L42	3,0 V ± 0,1 V	
2	V _T	—	Einen Gleichspannungsmesser zwischen TP6(V _T) und TP7(GND) anschließen.	108 MHz	TC1	25,0 V ± 0,2 V	
3	DETEKTOR (PLL)	98 MHz Hub. 75 kHz → OFF ANT-Eingang 120 dBμ	Einen Gleichspannungsmesser zwischen TP4(DET) und TP5(GND) anschließen.	98 MHz	L37	Den Kern drehen, und nach dem Prüfen des Ausgangs an Dev. 0 auf Dev OFF stellen. 0,000V ± 15 mV	
4	DETEKTOR (Quadratur)	98 MHz Hub. 75 kHz → OFF ANT-Eingang 120 dBμ	Einen Gleichspannungsmesser zwischen TP1(TUNED) und TP2(Vref) anschließen.	98 MHz	L35	Den Kern drehen, und nach dem Prüfen des Ausgangs an Dev. 0 auf Dev OFF stellen. 0,00V ± 30mV	
5	EMPFINDLICHKEIT	98 MHz AF 1 kHz ± 75 kHz Hub	—	98 MHz	L6, L7, L9, L11, L15	Wellenform bei Maximum und optimalem Zustand ausgeben.	
6	AUTOSTOPP-EMPFINDLICHKEIT	14 dBμ (ANT)	—	98 MHz	VR1	S-Messer Nr. 1 leuchtet. Digitalanzeige: 14 dBμ ± 0 dBμ	
7	AUTOSTOPP-EMPFINDLICHKEIT	70 dBμ (ANT)	—	98 MHz	VR17	Fünf S-Messer leuchtet. Digitalanzeige: 70 dBμ ± 1 dBμ	
8	VERZERRUNG (MONO)	MONO	Einen Verzerrungsmesser an die Ausgangsbuchse anschließen.	IF: WIDE (ZF: Breit)	VR5 VR6 VR9	Minimal Klirrfaktor.	
9	VERZERRUNG (MONO)	MONO		IF: NARROW (ZF: Schmal)	VR4 VR7		
10	VERZERRUNG (STEREO)	L/R	Einen Verzerrungsmesser an die Ausgangsbuchse anschließen.	IF: WIDE (ZF: Breit)	VR12	Minimal Klirrfaktor.	
11	VERZERRUNG (STEREO)	SUB		IF: WIDE (ZF: Breit)	VR8		
12	VERZERRUNG (STEREO)	L/R		IF: NARROW (ZF: Schmal)	VR11		
13	VERZERRUNG (STEREO)	SUB		IF: NARROW (ZF: Schmal)	VR10		
14	PILOT CANCEL	98 MHz Pilotten: 6,75 kHz Hub 80 dBμ Eingang	Einen Gleichspannungsmesser zwischen TP9(PG) und GND anschließen.	—	VR16	Den Pegel von 19 kHz auf Minimum einstellen.	
15	TRENNUNG	L/R 80 dBμ(ANT)	—	IF: WIDE (ZF: Breit)	VR14(L) VR15(R)	Optimale Trennung.	
16	TRENNUNG	L/R 80 dBμ(ANT)	—	IF: NARROW (ZF: Schmal)	VR13	Optimale Trennung.	
MW-EMPfangSABTEILUNG WÄHLER: AM(MW)							
(1)	AM-AUTOSTOPP-EMPFINDLICHKEIT	DIRECT-Eingang 28 dBμ (400Hz)	—	999 kHz	VR2	S-Messer Nr. 1 leuchtet.	

KT-6050 KT-6050

WIRING DIAGRAM

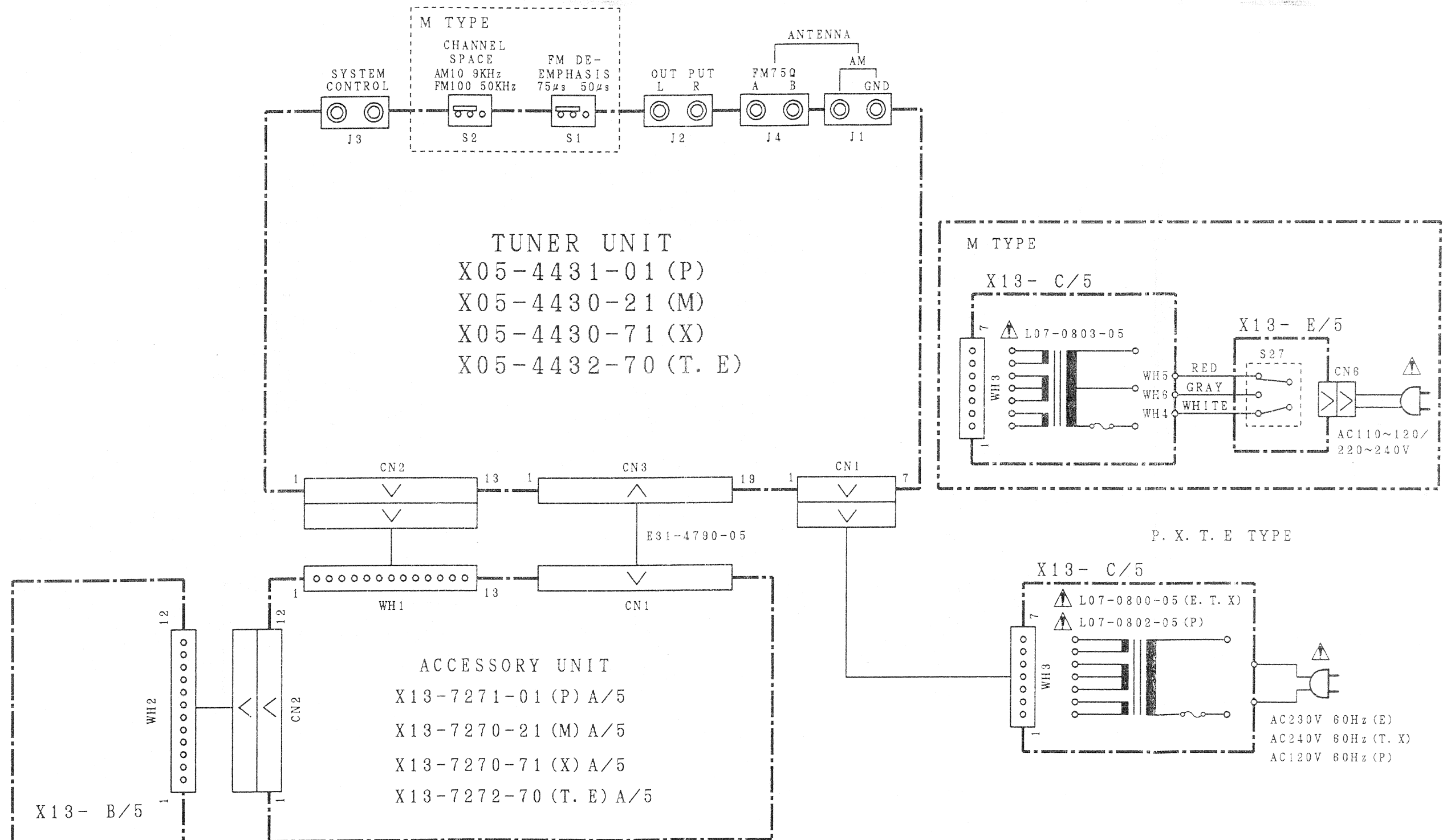

PC BOARD (Component side view)

TUNER UNIT (X05-443X-XX)

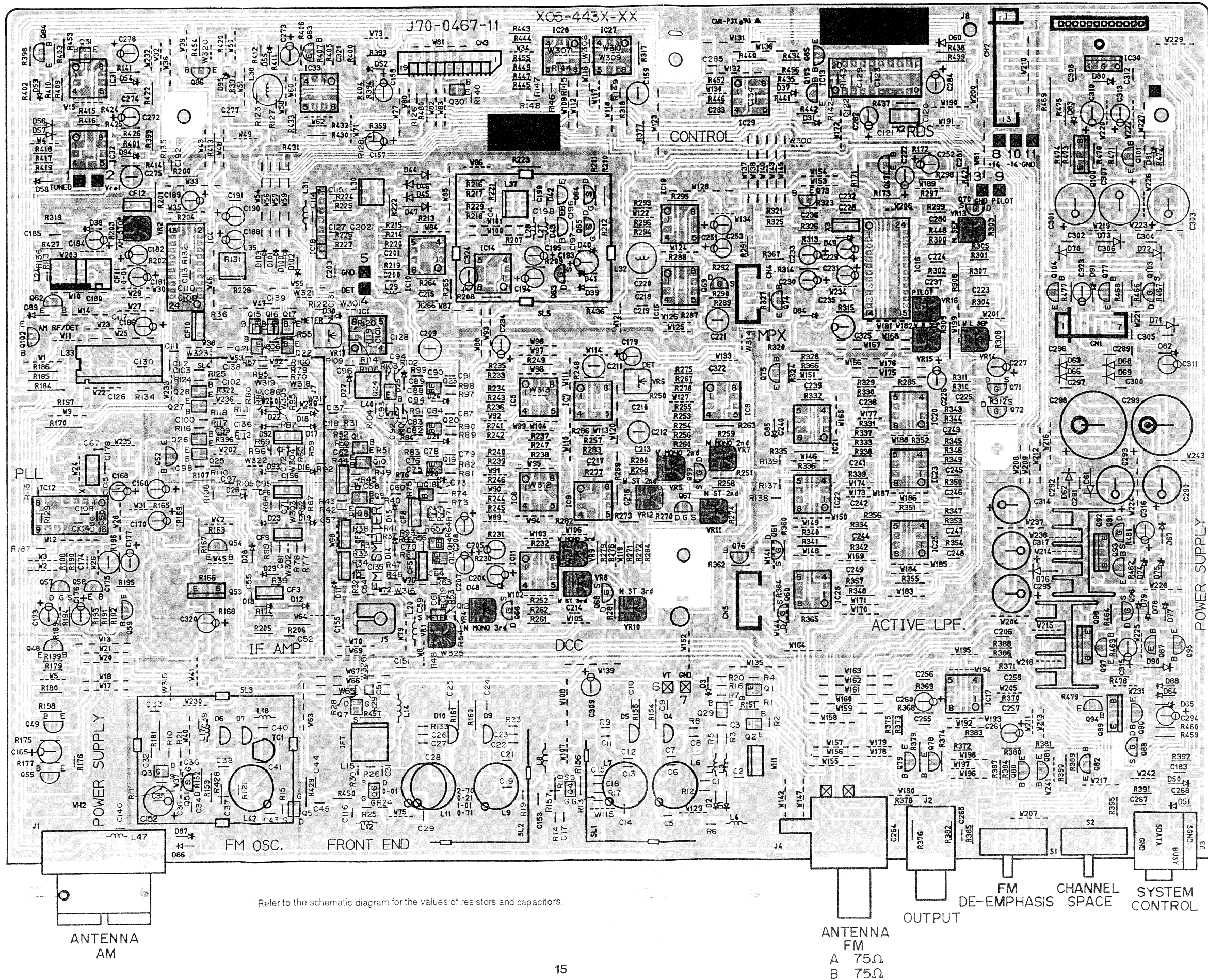

Refer to the schematic diagram for the values of resistors and capacitors.

ANTENNA FM
A 75Ω
B 75Ω

PC BOARD (Foil side view)

ACCESSORIES UNIT (X13-727X-XX)

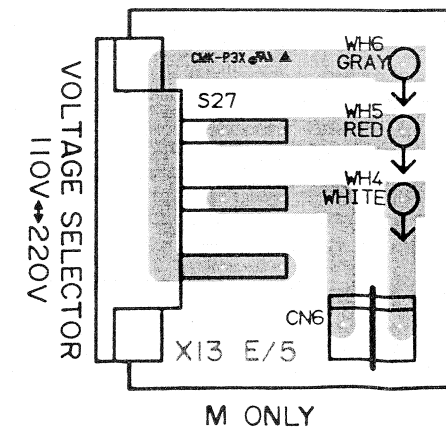
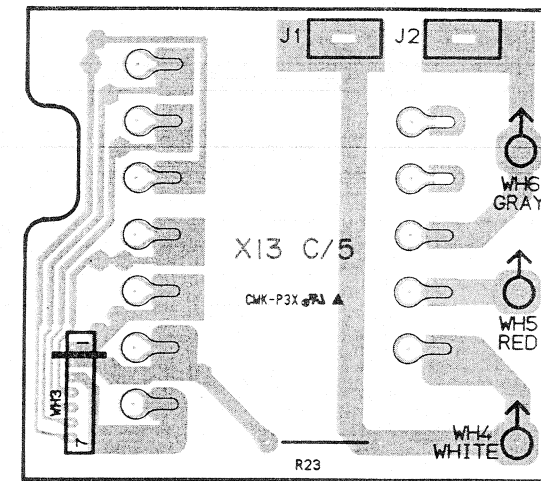
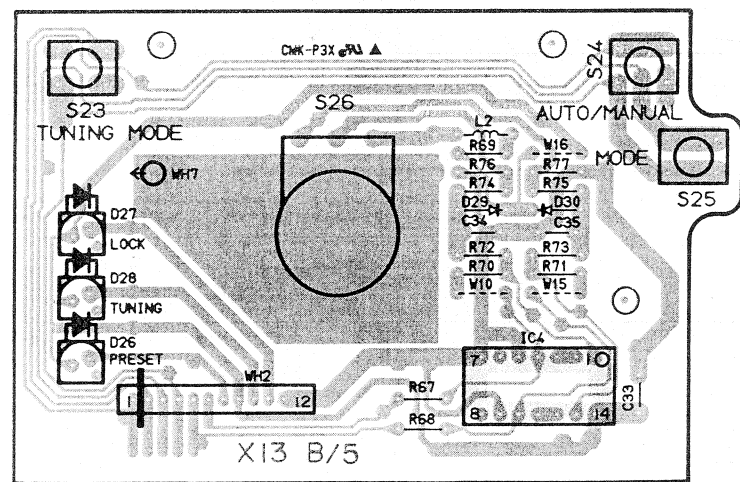
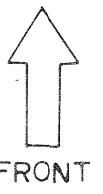
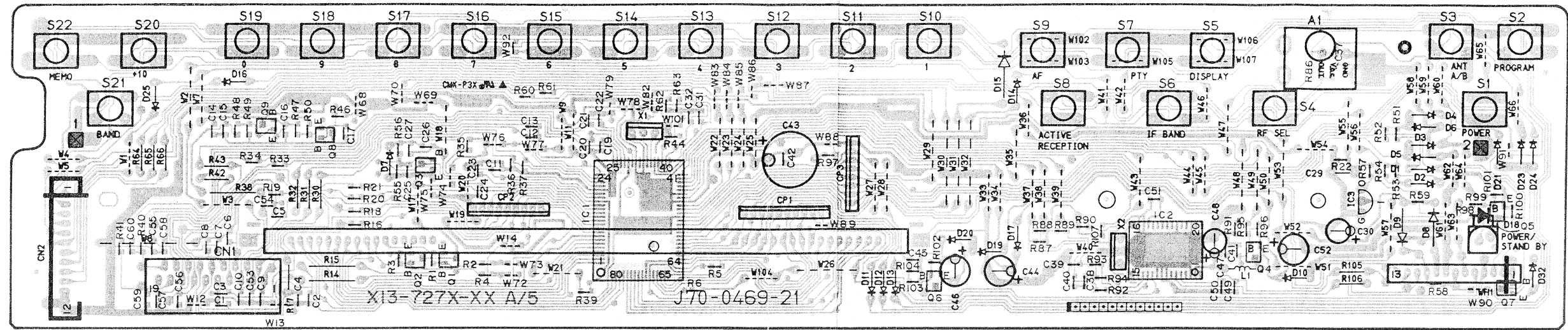

Refer to the schematic diagram for the values of resistors and capacitors.

X05-443X-XX

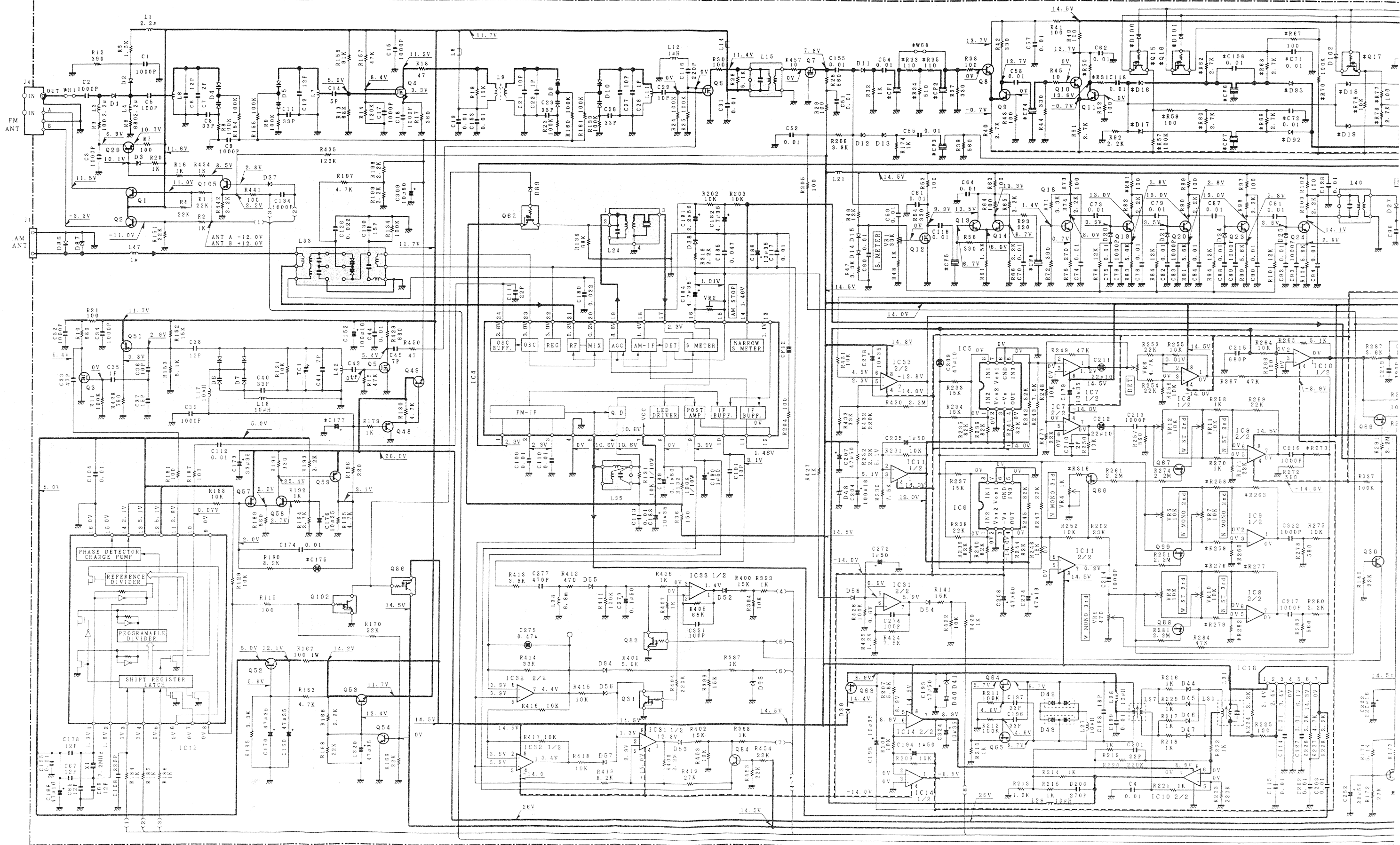

DC voltages are a during reception of 60 dB at the A1 variations between parentheses are as signal (with a signa

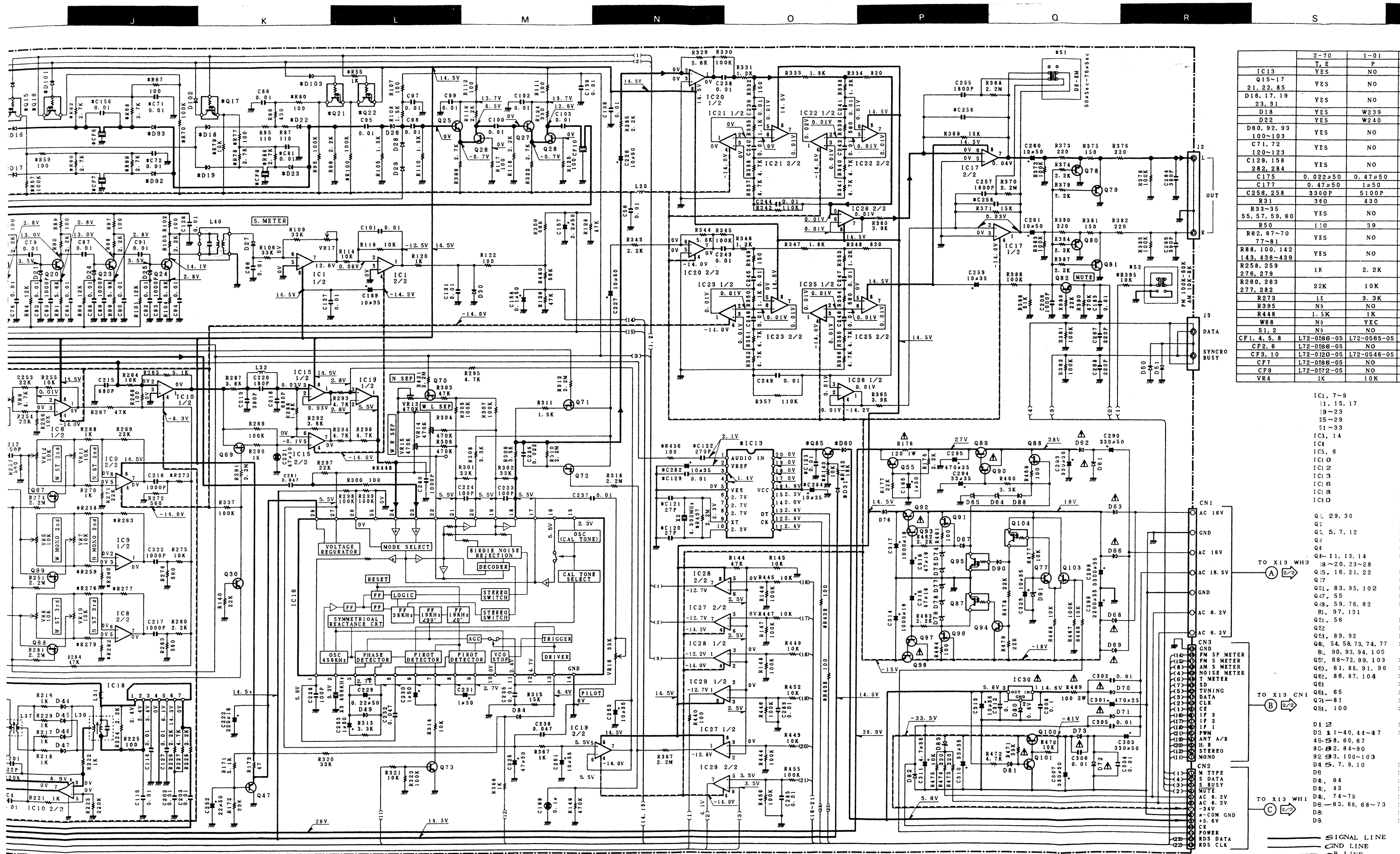

IC15-17	YES	NO
21, 22, 85	YES	NO
D18, 17, 19	YES	NO
D18	YES	W239
D22	YES	W240
D80, 92, 93	YES	NO
100-103	YES	NO
C71, 72	YES	NO
120-123	YES	NO
C129, 158	YES	NO
282, 284	YES	NO
C175	0.022µ50	0.47µ50
C177	0.47µ50	1µ50
C258, 258	3300P	5100P
R31	360	430
R33-35	YES	NO
55, 57, 59, 60	YES	NO
R50	110	39
R82, 87-70	YES	NO
77-81	YES	NO
R88, 100, 142	YES	NO
143, 438-439	YES	NO
R258, 259	1K	2.2K
276, 279	1K	2.2K
R280, 283	22K	10K
277, 282	1K	3.3K
R273	1K	3.3K
R395	N9	NO
R448	1.5K	1K
W88	N9	YEC
S1, 2	N9	NO
CF1, 4, 5, 8	L72-0586-05	L72-0585-05
CF2, 6	L72-0586-05	NO
CF3, 10	L72-0120-05	L72-0546-05
CF7	L72-0586-05	NO
CF9	L72-0572-05	NO
VR4	1K	10K

IC1, 7-9	11, 15, 17
19-23	19-23
25-29	25-29
31-33	31-33
IC3, 14	IC3, 14
IC4	IC4
IC5, 6	IC5, 6
IC10	IC10
IC12	IC12
IC13	IC13
IC16	IC16
IC18	IC18
IC10	IC10
Q1, 29, 30	Q1, 29, 30
Q2	Q2
Q3, 5, 7, 12	Q3, 5, 7, 12
Q4	Q4
Q6	Q6
Q7, 11, 13, 14	Q7, 11, 13, 14
Q8-20, 23-28	Q8-20, 23-28
Q15, 16, 21, 22	Q15, 16, 21, 22
Q17	Q17
Q21, 83, 95, 102	Q21, 83, 95, 102
Q47, 55	Q47, 55
Q48, 59, 76, 82	Q48, 59, 76, 82
Q5, 97, 101	Q5, 97, 101
Q51, 56	Q51, 56
Q52	Q52
Q53, 89, 92	Q53, 89, 92
Q4, 54, 58, 73, 74, 77	Q4, 54, 58, 73, 74, 77
Q8, 90, 93, 94, 105	Q8, 90, 93, 94, 105
Q5, 68-72, 99, 103	Q5, 68-72, 99, 103
Q6, 81, 88, 91, 96	Q6, 81, 88, 91, 96
Q62, 86, 87, 104	Q62, 86, 87, 104
Q63	Q63
Q61, 65	Q61, 65
Q7, 81	Q7, 81
Q9, 100	Q9, 100
D1, 2	D1, 2
D3, 1-40, 44-47	D3, 1-40, 44-47
48-58, 60, 67	48-58, 60, 67
80-82, 84-90	80-82, 84-90
92-93, 100-103	92-93, 100-103
D4, 5, 7, 9, 10	D4, 5, 7, 9, 10
D6	D6
D4, 64	D4, 64
D4, 43	D4, 43
D4, 74-79	D4, 74-79
D6-83, 66, 68-73	D6-83, 66, 68-73
D8	D8
D9	D9

DC voltages are as measured with a high impedance voltmeter during reception of the FM broadcast signal (with a signal strength of 60 dB at the ANT terminal). Values may vary slightly due to variations between individual instruments or/and units. Values in parentheses are as measured during reception of the AM broadcast signal (with a signal strength of 60 dB at the ANT terminal).

Les tensions c.c. doivent être mesurées avec un voltmètre à haute impédance pendant la réception d'un signal de programme FM (avec une force de signal de 60 dB à la borne ANT). Les valeurs peuvent différer légèrement du fait des variations inhérentes aux appareils et aux instruments de mesure individuels. Les valeurs entre parenthèses doivent être mesurées pendant la réception d'un signal de programme AM (avec une force de signal de 60 dB à la borne ANT).

Die angegebenen Gleichspannungswerte wurden mit einem hochohmigen Spannungsmesser bei Empfang eines UKW-Signals (mit einer Feldstärke von 60 dB am Antennenanschluß) gemessen. Dabei schwanken die Meßwerte aufgrund von Unterschieden zwischen einzelnen Instrumenten oder Geräten u. U. geringfügig. Die eingeklammerten Gleichspannungswerte wurden bei Empfang eines MW-Signals (mit einer Feldstärke von 60 dB am Antennenanschluß) gemessen.

CAUTION: For continued safety, replace safety critical components only with manufacturer's recommended parts (refer to parts list). Δ indicates safety critical components. To reduce the risk of electric shock, leakage-current or resistance measurements shall be carried out (exposed parts are acceptably insulated from the supply circuit) before the appliance is returned to the customer.

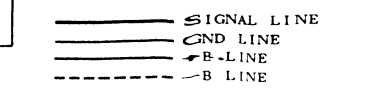

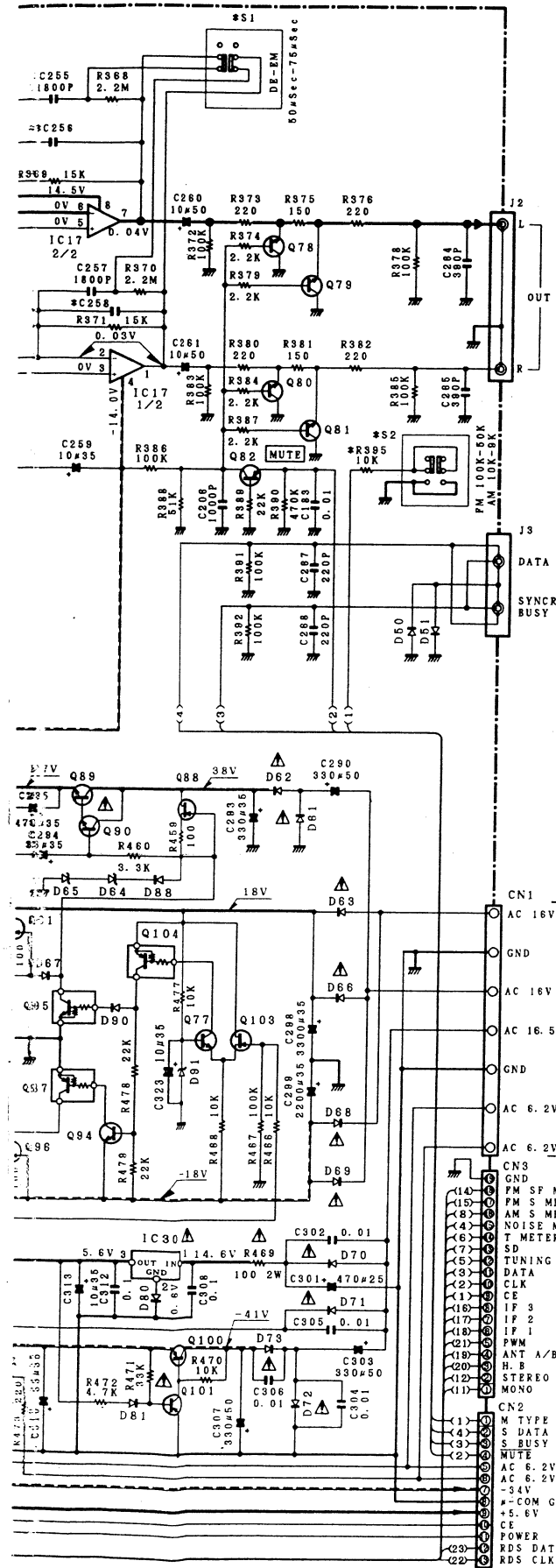

	2-70	1-01	0-21	0-71
IC13	T, E	P	M	X
Q15-17	YES	NO	NO	YES
21, 22, 85	YES	NO	NO	YES
D16, 17, 18	YES	NO	NO	YES
23, 31	YES	W238	W238	YES
D18	YES	W240	W240	YES
D22	YES	W240	W240	YES
D60, 92, 93	YES	NO	NO	YES
100-103	YES	NO	NO	YES
C71, 72	YES	NO	NO	YES
120-123	YES	NO	NO	YES
C129, 158	YES	NO	NO	YES
282, 284	YES	NO	NO	YES
C175	0.022µ50	0.47µ50	0.47µ50	0.47µ50
C177	0.47µ50	1µ50	1µ50	1µ50
C256, 258	3300P	5100P	3300P	3300P
R31	360	430	430	360
R33-35	YES	NO	NO	YES
55, 57, 59, 60	YES	NO	NO	YES
R50	110	39	39	110
R62, 67-70	YES	NO	NO	YES
77-81	YES	NO	NO	YES
R88, 100, 142	YES	NO	NO	YES
143, 436-439	YES	NO	NO	YES
R258, 259	1K	2.2K	2.2K	2.2K
276, 279	1K	2.2K	2.2K	2.2K
R260, 263	22K	10K	10K	10K
277, 282	1K	3.3K	3.3K	1K
R273	1K	3.3K	3.3K	1K
R395	NO	NO	YES	NO
R448	1.5K	1K	1K	1.5K
W68	NO	YEC	YEC	NO
S1, 2	NO	NO	YES	NO
CF1, 4, 5, 8	L72-0586-05	L72-0565-05	L72-0565-05	L72-0565-05
CF2, 6	L72-0586-05	NO	NO	NO
CF3, 10	L72-0120-05	L72-0548-05	L72-0548-05	L72-0548-05
CF7	L72-0586-05	NO	NO	NO
CF9	L72-0572-05	NO	NO	NO
VR4	1K	10K	10K	10K

- IC1, 7-9 : NJM4565D
- 11, 15, 17
- 19-23
- 25-29
- 31-33
- IC9, 14 : NJM4558D
- IC4 : LA1267
- IC5, 6 : NJM4200D
- IC10 : NJM4560D-A
- IC12 : LM7001
- IC13 : TDA7330B
- IC16 : LA3450
- IC18 : TA7302P
- IC30 : #PC7805AHF
- Q1, 29, 30 : 2SA1037K
- Q2 : 2SC2412K
- Q3, 5, 7, 12 : 2SK302 (Y, GR)
- Q4 : 3SK226
- Q6 : 3SK151 (GR)
- Q8-11, 13, 14 : 2SC2714 (R, O)
- 18-20, 23-28
- Q15, 16, 21, 22 : DTA124EK
- Q17 : DTC114TK
- Q31, 83, 95, 102 : DTC124ES
- Q47, 55 : 2SA1534A (R, S)
- Q48, 59, 76, 82 : 2SA1048 (Y, GR)
- 85, 97, 101 : or 2SA1309A (Q, R)
- Q51, 56 : 2SK709 (BL, V)
- Q52 : 2SC3940A (R, S)
- Q53, 89, 92 : 2SD2012
- Q49, 54, 58, 73, 74, 77 : 2SC2458 (Y, GR)
- 84, 90, 93, 94, 105 : or 2SC3311 (Q, R)
- Q57, 66-72, 99, 103 : 2SK246 (Y, GR)
- Q60, 61, 88, 91, 96 : 2SK163 (L, M)
- Q62, 86, 87, 104 : DTA124ES
- Q63 : 2SK163 (M)
- Q64, 65 : 2SK161 (GR)
- Q78-81 : 2SC2878 (B)
- Q98, 100 : 2SB1375
- D1, 2 : 1SV157
- D3, 11-40, 44-47 : 1SS133 or HSS104
- 49-58, 60, 67
- 80-82, 84-90
- 92, 93, 100-103
- D4, 5, 7, 9, 10 : KV1302-5 or KV1302-6
- D6 : KV1302-6
- D41, 64 : KV1320-2
- D42, 43 : RD8, 2JS (B2) or HZS8, 2S (B2)
- D48, 74-79 : RD5, 1JS (B2) or HZS5, 1JS (B2)
- D61-63, 66, 68-73 : S5688B or 1SR139-100
- D83 : RD6, 8ES (B2) or HZS8, 2S (B2)
- D91 : RD3, 9ES (B2) or HZS3, 9N (B2)

TO X13 WH3

TO X13 CN1

TO X13 WH1

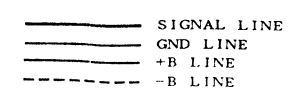

CAUTION: For continued safety, replace safety critical components only with manufacturer's recommended parts (refer to parts list). ⚠ indicates safety critical components. To reduce the risk of electric shock, leakage-current or resistance measurements shall be carried out (exposed parts are acceptably insulated from the supply circuit) before the appliance is returned to the customer.

X13-727X-XX (A/3)

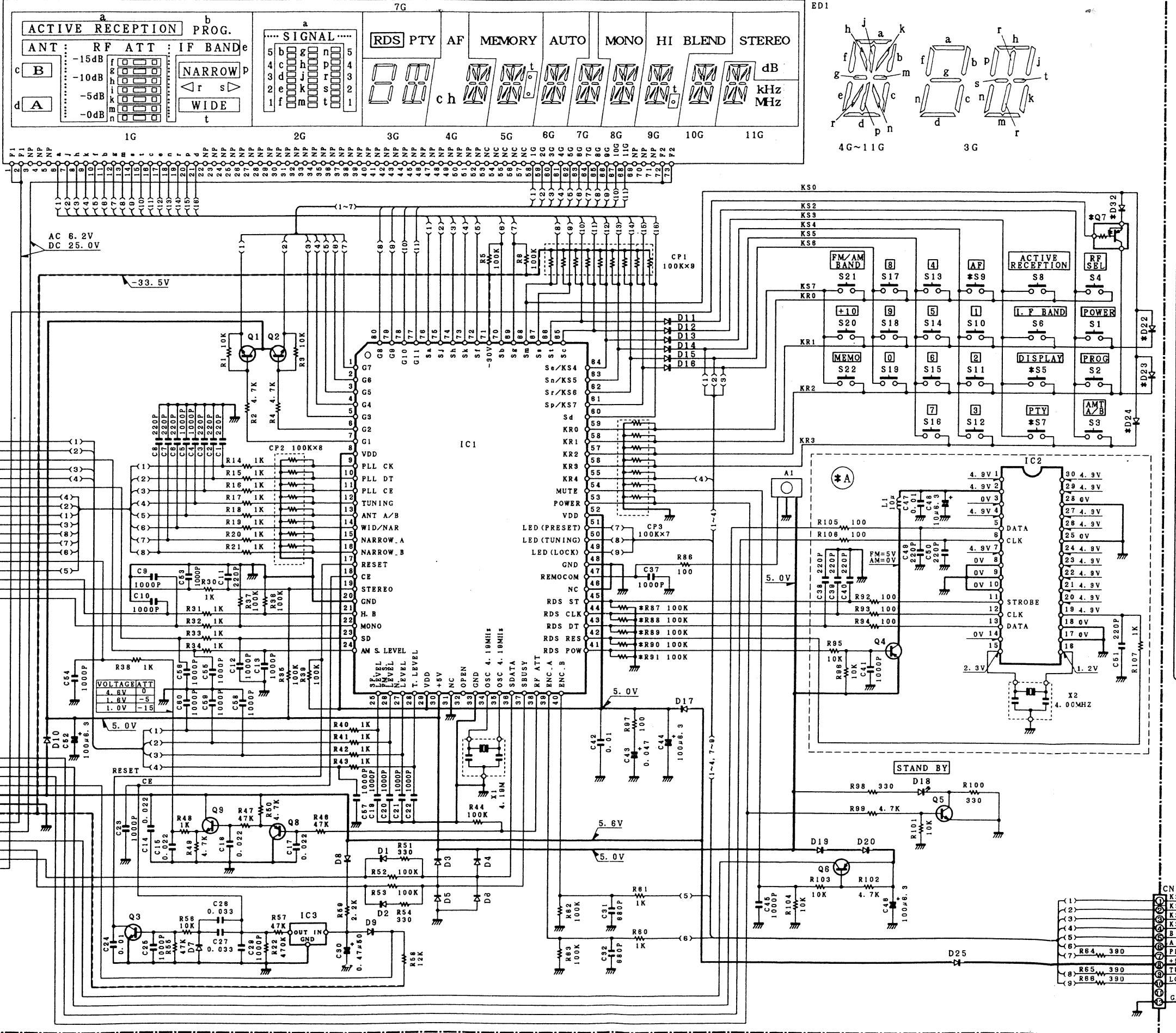

- IC1 : #PD78043GF-043
- IC2 : LC6543H-4600
- IC3 : S-80740AL
- IC4 : #PD4069UB
- Q1~3, 5, 9 : 2SC2412K
- Q4, 6, 8 : 2SA1037K
- Q7 : DTA143EK
- D1~17, 19~25 : 1SS133 OR HSS104
- 29, 30, 32
- D18, 26~28 : B30-1012-05

Ref. No.	D22	D23	D24	D32	Q7	R
1-01	P	YES	YES	NO	NO	NO
0-21	M	NO	NO	NO	YES	YES
0-71	X	NO	NO	YES	NO	NO
2-70	T. E	NO	NO	NO	NO	NO

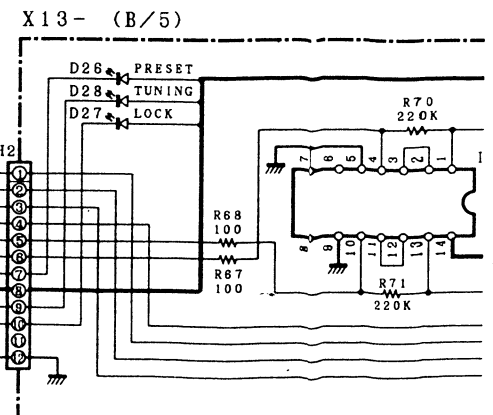
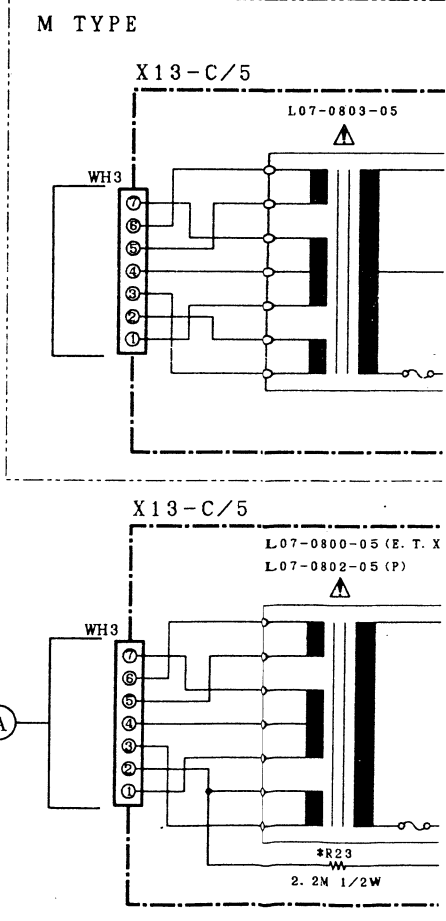

2
3
4
5
6
7

TO X05 CN1
TO X05 CN3
TO X05 CN2

FM. SF. METER
FM. S. METER
AM. S. METER
N. METER
T. METER
SD
TUNING
PLL DATA
PLL CLK
PLL CE
IF3
IF2
IF1
PWM
ANT. A/B
HI BLEND
STEREO
MONO

RDS CLK
RDS DATA
POWER
CE
5.6V
+COM GND
-34V
AC 6.2V
AC 8.2V
MUTE
S BUSY
S DATA
CH SPACE

CN2 WH2
KS5
KS6
KS7
KS4
B
A
PRESET
+5V
TUNING
LOCK
GND

IC1 : #PD78043GF-043
 IC2 : LC6543H-4600
 IC3 : S-80740AL
 IC4 : #PD4069UB

Q1~3, 5, 9 : 2SC2412K
 Q4, 6, 8 : 2SA1037K
 Q7 : DTA143EK

D1~17, 19~25 : 1SS133 OR HSS104
 29, 30, 32
 D18, 26~28 : B30-1012-05

Ref. No.	D22	D23	D24	D32	Q7	R23	R87~91	S5, 7, 9	E/5	(A)
1-01 P	YES	YES	NO	NO	NO	YES	YES	NO	NO	NO
0-21 M	NO	NO	YES	YES	YES	NO	YES	NO	YES	NO
0-71 X	NO	NO	YES	NO	NO	NO	YES	NO	NO	NO
2-70 T. E	NO	NO	NO	NO	NO	NO	NO	YES	NO	YES

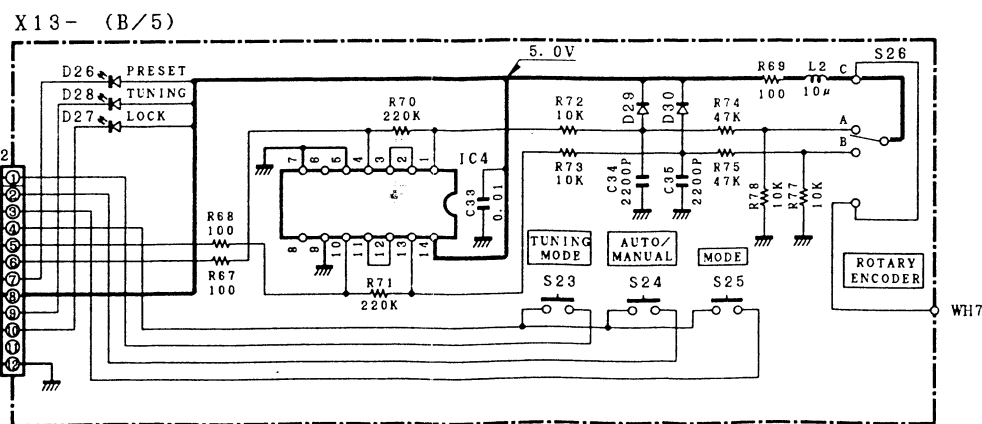
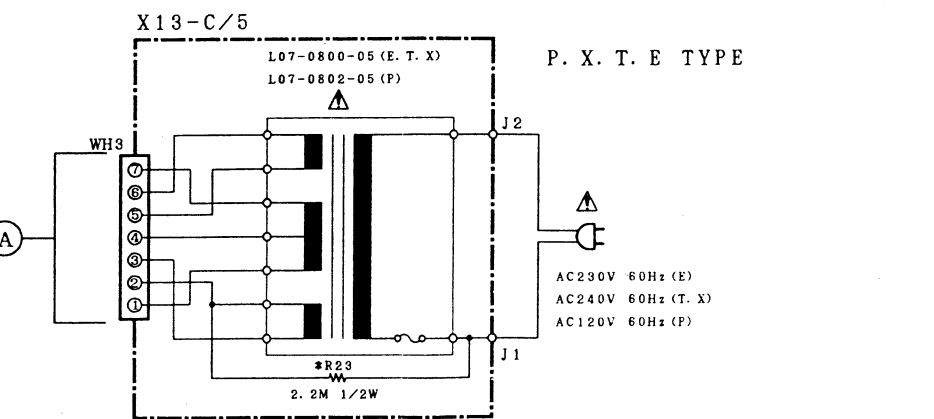
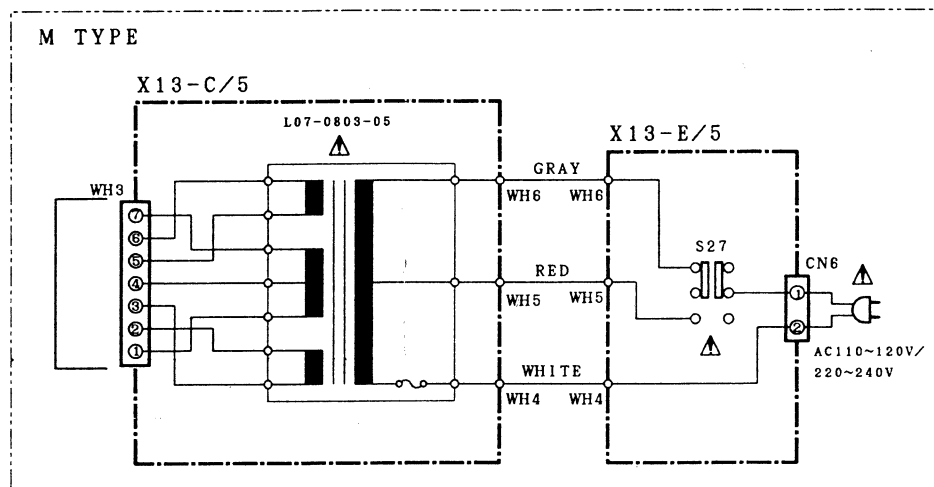

— SIGNAL LINE
 — GND LINE
 — +B LINE
 - - - -B LINE

CAUTION: For continued safety, replace safety critical components only with manufacturer's recommended parts (refer to parts list). Δ indicates safety critical components. To reduce the risk of electric shock, leakage-current or resistance measurements shall be carried out (exposed parts are acceptably insulated from the supply circuit) before the appliance is returned to the customer.

DC voltages are as measured with a high impedance voltmeter during reception of the FM broadcast signal (with a signal strength of 60 dB at the ANT terminal). Values may vary slightly due to variations between individual instruments or/and units. Values in parentheses are as measured during reception of the AM broadcast signal (with a signal strength of 60 dB at the ANT terminal).

Les tensions c.c. doivent être mesurées avec un voltmètre à haute impédance pendant la réception d'un signal de programme FM (avec une force de signal de 60 dB à la borne ANT). Les valeurs peuvent différer légèrement du fait des variations inhérentes aux appareils et aux instruments de mesure individuels. Les valeurs entre parenthèses doivent être mesurées pendant la réception d'un signal de programme AM (avec une force de signal de 60 dB à la borne ANT).

Die angegebenen Gleichspannungswerte wurden mit einem hochohmigen Spannungsmesser bei Empfang eines UKW-Signals (mit einer Feldstärke von 60 dB am Antennenanschluß) gemessen. Dabei schwanken die Meßwerte aufgrund von Unterschieden zwischen einzelnen Instrumenten oder Geräten u. U. geringfügig. Die eingeklammerten Gleichspannungswerte wurden bei Empfang eines MW-Signals (mit einer Feldstärke von 60 dB am Antennenanschluß) gemessen.

2SA1534A
 2SC2878
 2SC3940A

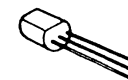

DTA124ES
 DTC124ES
 2SA1048
 2SC2458

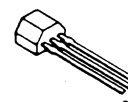

DTA124EK
 DTA143EK
 DTC114TK
 2SA1037K
 2SC2412K
 2SC2714

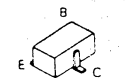

2SA1309A
 2SC3311A

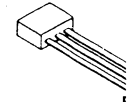

2SB1375
 2SD2012

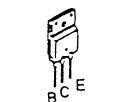

NJM4200D
 NJM4558D
 NJM4560D-A

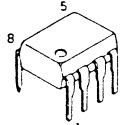

2SA1534A
2SC2878
2SC3940A

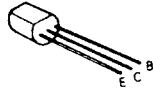

TA7302P

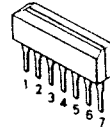

2SK246

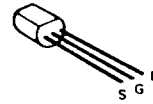

DTA124ES
DTC124ES
2SA1048
2SC2458

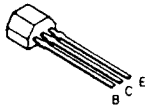

NJM4565D

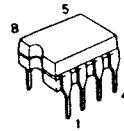

2SK163

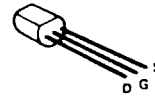

DTA124EK
DTA143EK
DTC114TK
2SA1037K
2SC2412K
2SC2714



UPD4069UBC

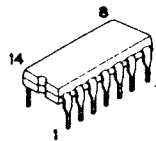

2SK161

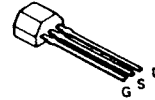

LM7001

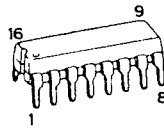

2SK302



2SA1309A
2SC3311A

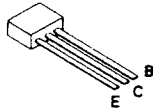

TDA7330B

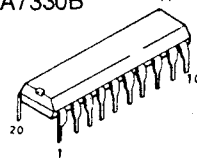

LA1267

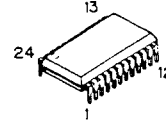

2SB1375
2SD2012



LA3450

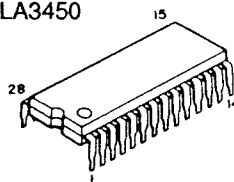

TA7805S

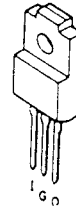

NJM4200D
NJM4558D
NJM4560D-A

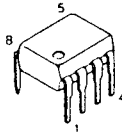

UPC7805AHF

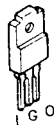

S-80740AL

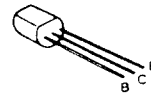

EXPLODED VIEW

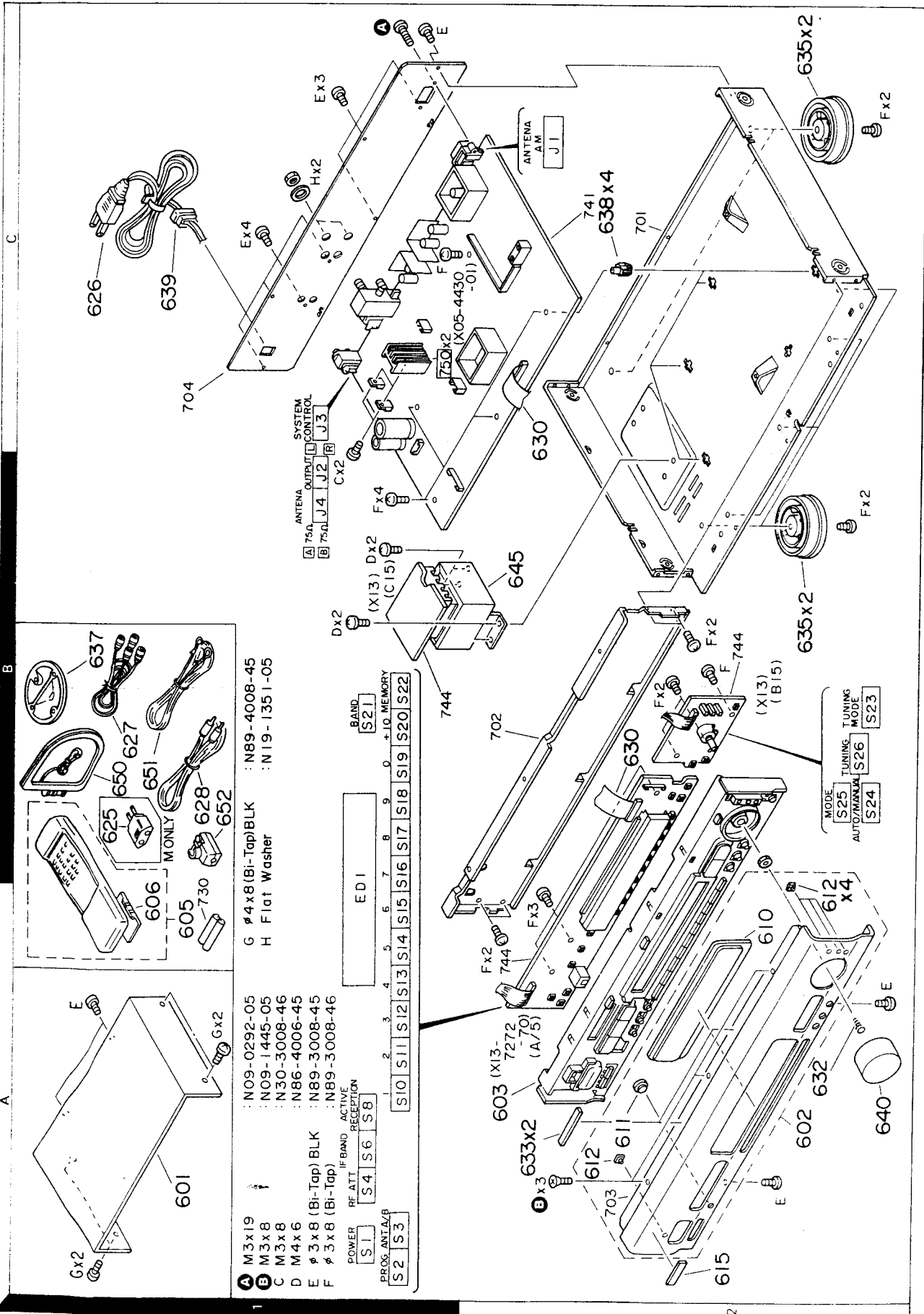

Parts with the exploded numbers larger than 700 are not supplied.

PARTS LIST

TUNER UNIT

Unit No.	Destination
X05-4431-01	P
X05-4430-21	M
X05-4430-71	X
X05-4432-70	T, E

ACCESSORIES UNIT

Unit No.	Destination
X13-7271-01	P
X13-7270-21	M
X13-7270-71	X
X13-7272-70	T, E

* New Parts

Parts without Parts No. are not supplied.

Les articles non mentionnés dans le Parts No. ne sont pas fournis.

Telle ohne Parts No. werden nicht geliefert.

No. 1

Ref. No.	Address	New Parts	Parts No.	Description	Destination	Remarks
参照番号	位置	新	部品番号	部品名 / 規格	仕向	備考
KT-6050 (UNIT)						
601	1A		A01-1801-01	METALLIC CABINET		
602	2A	*	A60-0431-02	PANEL ASSY	ET	
602	2A	*	A60-0432-02	PANEL ASSY	PMX	
603	2A	*	A22-1641-01	SUB PANEL		
605	1A	*	A70-0940-05	REMOTE CONTROLLER ASSY	PMX	
606	1A		A09-0146-08	BATTERY COVER	PMX	
610	2A		B10-1863-03	FRONT GLASS		
611	2A		B11-0237-14	COLOR FILTER		
612	2A	*	B12-0162-14	INDICATOR		
615	2A		B43-0287-04	KENWOOD BADGE		
-	-		B46-0096-33	WARRANTY CARD	X	
-	-	*	B46-0121-33	WARRANTY CARD	P	
-	-		B46-0310-03	WARRANTY CARD	ET	
-	-		B58-0945-03	CAUTION CARD	T	
-	-	*	B60-1238-00	INSTRUCTION MANUAL (ENGLISH)	PMX	
-	-	*	B60-1240-00	INSTRUCTION MANUAL (FRENCH)	P	
-	-	*	B60-1241-00	INSTRUCTION MANUAL (GER, FER)	E	
-	-	*	B60-1242-00	INSTRUCTION MANUAL (DUT, ITA)	M	
-	-	*	B60-1243-00	INSTRUCTION MANUAL (SPA, CHI)	E	
-	-	*	B60-1418-00	INSTRUCTION MANUAL (ENGLISH)	ET	
625	1B		E03-0115-05	AC PLUG ADAPTER	M	
626	1C		E30-0459-05	AC POWER CORD	P	
626	1C		E30-0974-05	AC POWER CORD	P	
626	1C		E30-2592-15	AC POWER CORD	M	
626	1C		E30-2714-05	AC POWER CORD	X	
626	1C		E30-2718-05	AC POWER CORD	T	
627	1B		E30-0505-05	AUDIO CORD		
628	1B		E30-2733-05	CORD WITH PLUG		
630	2B, 2C		E31-4790-05	FLAT CABLE X05(CN3)-X13(CN1)		
632	2A		G01-3451-04	COMPRESSION SPRING		
633	2A		G11-0155-14	SOFT TAPE (40X9X2)		
-	-	*	H50-0700-04	ITEM CARTON CASE	EPMX	
-	-	*	H50-0701-04	ITEM CARTON CASE	T	
-	-	*	H10-5162-12	POLYSTYRENE FOAMED FIXTURE L		
-	-	*	H10-5163-02	POLYSTYRENE FOAMED FIXTURE R		
-	-	*	H12-2138-04	PACKING FIXTURE	T	
-	-	*	H13-0102-04	CARTON BOARD	X	
-	-		H25-0224-04	PROTECTION BAG (800X400X0.03)	EPMX	
-	-		H25-0232-04	PROTECTION BAG (235X350X0.03)	EPMX	
-	-		H25-0651-04	PROTECTION BAG (0232 PRINTED)	T	
-	-		H25-0653-04	PROTECTION BAG (0224 PRINTED)	T	
635	2B, 2C		J02-1072-05	FOOT		
637	1B		J19-2815-04	ANTENNA HOLDER		
638	2C		J19-3180-05	UNIT HOLDER		
639	1C		J42-0083-05	POWER CORD BUSHING		
-	-		J61-0307-05	WIRE BAND		
640	2A		K29-4292-14	KNOB TUNING,PTY SELECT		
645	2B	*	L07-0800-05	POWER TRANSFORMER	EXT	
645	2B	*	L07-0802-05	POWER TRANSFORMER	P	
645	2B	*	L07-0803-05	POWER TRANSFORMER	M	

L:Scandinavia K:USA P:Canada
 Y:PX(Far East, Hawaii) T:England E:Europe
 Y:AAFES(Europe) X:Australia M:Other Areas

⚠ indicates safety critical components.

* New Parts

Parts without Parts No. are not supplied.

Les articles non mentionnés dans le Parts No. ne sont pas fournis.

Telle ohne Parts No. werden nicht geliefert.

No. 2

Ref. No.	Address	New Parts	Parts No.	Description	Destination	Remarks
参照番号	位置	新	部品番号	部品名 / 規格	仕向	備考
A	1C		N09-0292-05	BRAZIER HEAD STEPPED SCREW		
B	2A		N09-1445-05	SET SCREW (M3X8)		
D	1B		N86-4006-45	BINDING HEAD TAPTITE SCREW		
E	1A, 1C		N89-3008-45	BINDING HEAD TAPTITE SCREW		
F	1B, 1C		N89-3008-46	BINDING HEAD TAPTITE SCREW		
G	1A		N89-4008-45	BINDING HEAD TAPTITE SCREW		
H	1C	*	N19-1351-05	FLAT WASHER		
650	1B		T90-0173-05	LOOP ANTENNA		
650	1B		T90-0174-05	LOOP ANTENNA		
651	1B		T90-0176-05	T TYPE ANTENNA		
652	1B		T90-0185-05	ANTENNA ADAPTOR		
TUNER UNIT (X05-443X-XX)						
C1	-3		CK73FB1H102K	CHIP C 1000PF	K	
C5			CC73FSL1H101J	CHIP C 100PF	J	
C6			CC73FTH1H120J	CHIP C 12PF	J	
C7			CC73FCH1H020C	CHIP C 2.0PF	C	
C8		*	CC73FPH1H330J	CHIP C 33PF	J	
C9			CK73FB1H102K	CHIP C 1000PF	K	
C11		*	CC73FPH1H330J	CHIP C 33PF	J	
C12			CC73FTH1H120J	CHIP C 12PF	J	
C14			CC73FSL1H050C	CHIP C 5PF	C	
C15			CK73FB1H102K	CHIP C 1000PF	K	
C17	.18		CK73FB1H102K	CHIP C 1000PF	K	
C19			CK73FB1H103K	CHIP C 0.010UF	K	
C21			CC73FTH1H100D	CHIP C 10PF	D	
C22			CC73FSL1H010C	CHIP C 1PF	C	
C23		*	CC73FPH1H330J	CHIP C 33PF	J	
C26		*	CC73FPH1H330J	CHIP C 33PF	J	
C27			CC73FTH1H100D	CHIP C 10PF	D	
C28			CC73FSL1H010C	CHIP C 1PF	C	
C29			CC73FSL1H100D	CHIP C 10PF	D	
C31			CK73FB1H103K	CHIP C 0.010UF	K	
C32			CK73FB1H102K	CHIP C 1000PF	K	
C33			CC73FSL1H470J	CHIP C 47PF	J	
C34			CK73FB1H102K	CHIP C 1000PF	K	
C35			CC73FSL1H010C	CHIP C 1PF	C	
C36			CC73FCH1H100D	CHIP C 10PF	D	
C37			CC73FCH1H150J	CHIP C 15PF	J	
C38			CC73FTH1H120J	CHIP C 12PF	J	
C39			CK73FB1H102K	CHIP C 1000PF	K	
C40		*	CC73FPH1H330J	CHIP C 33PF	J	
C41			CC73FTH1H070D	CHIP C 7PF	D	
C43			CC73FSL1H010C	CHIP C 1PF	C	
C44			CK73FB1H103K	CHIP C 0.010UF	K	
C45			CC73FSL1H070D	CHIP C 7PF	D	
C51	.52		CK73FB1H103K	CHIP C 0.010UF	K	
C54	.55		CK73FB1H103K	CHIP C 0.010UF	K	
C57	-62		CK73FB1H103K	CHIP C 0.010UF	K	
C64			CK73FB1H103K	CHIP C 0.010UF	K	
C65	-67		CC73FCH1H120J	CHIP C 12PF	J	
C70			CK73FB1H103K	CHIP C 0.010UF	K	PMX
C70	-75		CK73FB1H103K	CHIP C 0.010UF	K	ET
C73	-75		CK73FB1H103K	CHIP C 0.010UF	K	PMX
C76			CK73FB1H102K	CHIP C 1000PF	K	

L:Scandinavia K:USA P:Canada
 Y:PX(Far East, Hawaii) T:England E:Europe
 Y:AAFES(Europe) X:Australia M:Other Areas

⚠ indicates safety critical components.

PARTS LIST

KT-6050

× New Parts

Parts without Parts No. are not supplied.

Les articles non mentionnés dans le Parts No. ne sont pas fournis.

Teile ohne Parts No. werden nicht geliefert.

No. 3

Ref. No. 参照番号	Address 位置	New Parts	Parts No. 部品番号	Description 部品名 / 規格	Desti- nation 仕向	Re- marks 備考
C78, 79			CK73FB1H103K	CHIP C 0.010UF K		
C81, 82			CK73FB1H103K	CHIP C 0.010UF K	ET	
C82			CK73FB1H103K	CHIP C 0.010UF K	PMX	
C83			CK73FB1H102K	CHIP C 1000PF K		
C84			CK73FB1H103K	CHIP C 0.010UF K		
C86 -88			CK73FB1H103K	CHIP C 0.010UF K	ET	
C87, 88			CK73FB1H103K	CHIP C 0.010UF K	PMX	
C89			CK73FB1H102K	CHIP C 1000PF K		
C90 -92			CK73FB1H103K	CHIP C 0.010UF K		
C93			CK73FB1H102K	CHIP C 1000PF K		
C94 -105			CK73FB1H103K	CHIP C 0.010UF K		
C108			CC73FSL1H221J	CHIP C 220PF J		
C109, 110			CK73FB1H103K	CHIP C 0.010UF K		
C111			CC73FSL1H220J	CHIP C 22PF J		
C112-115			CK73FB1H103K	CHIP C 0.010UF K		
C116			CC73FSL1H221J	CHIP C 220PF J		
C117-119			CK73FB1H103K	CHIP C 0.010UF K		
C120, 121			CC73FCH1H270J	CHIP C 27PF J	ET	
C122			CC73FSL1H271J	CHIP C 270PF J	ET	
C123			CK73FB1H103K	CHIP C 0.010UF K	ET	
C126			CK73FF1H223Z	CHIP C 0.022UF Z		
C127-129			CK73FB1H103K	CHIP C 0.010UF K	ET	
C127, 128			CK73FB1H103K	CHIP C 0.010UF K	PMX	
C131-133			CK73FB1H103K	CHIP C 0.010UF K		
C134			CK73FB1H102K	CHIP C 1000PF K		
C139			CK73FB1H103K	CHIP C 0.010UF K		
C152			CE04KW1H101M	ELECTR0 100UF 50WV		
C153			CK45FF1H103Z	CERAMIC 0.010UF Z		
C155			C91-0769-05	CERAMIC 0.01UF K	PMX	
C155, 156			C91-0769-05	CERAMIC 0.01UF K	ET	
C157			CE04KW1H2R2M	ELECTR0 2.2UF 50WV		
C158			CE04KW1HOR1M	ELECTR0 0.1UF 50WV		
C160			CE04KW1V470M	ELECTR0 47UF 35WV		
C165			CE04KW1V470M	ELECTR0 47UF 35WV		
C168			CE04KW1A470M	ELECTR0 47UF 10WV		
C170			CE04KW1V470M	ELECTR0 47UF 35WV		
C173			CE04KW1V330M	ELECTR0 33UF 35WV		
C174			CF92FV1H103J	MF 0.010UF J		
C175			CE04HW1HR22M	NP-ELEC 0.22UF 50WV	ET	
C175			CE04HW1HR47M	NP-ELEC 0.47UF 50WV	PMX	
C176			CE04KW1V100M	ELECTR0 10UF 35WV		
C177			CE04KW1HR47M	ELECTR0 0.47UF 50WV	ET	
C177			CE04KW1H010M	ELECTR0 1.0UF 50WV	PMX	
C178			CC45FCH1H120J	CERAMIC 12PF J		
C179			CE04KW1V100M	ELECTR0 10UF 35WV		
C180			CK45FF1H223Z	CERAMIC 0.022UF Z		
C181			CE04KW1H2R2M	ELECTR0 2.2UF 50WV		
C182			CE04KW1V4R7M	ELECTR0 4.7UF 35WV		
C183			CK45FF1H103Z	CERAMIC 0.010UF Z		
C184			CE04KW1V4R7M	ELECTR0 4.7UF 35WV		
C185			CK45FF1H473Z	CERAMIC 0.047UF Z		
C186			CE04KW1V100M	ELECTR0 10UF 35WV		
C188			CE04KW1V100M	ELECTR0 10UF 35WV		
C189			CE04KW1HOR1M	ELECTR0 0.1UF 50WV		
C190			CE04KW1H010M	ELECTR0 1.0UF 50WV		

L:Scandinavia K:USA P:Canada
Y:PX(Far East, Hawaii) T:England E:Europe
Y:AFES(Europe) X:Australia M:Other Areas

△ indicates safety critical components

× New Parts

Parts without Parts No. are not supplied.

Les articles non mentionnés dans le Parts No. ne sont pas fournis.

Teile ohne Parts No. werden nicht geliefert.

No. 4

Ref. No. 参照番号	Address 位置	New Parts	Parts No. 部品番号	Description 部品名 / 規格	Desti- nation 仕向	Re- marks 備考
C191			CC45FSL1H100D	CERAMIC 10PF D		
C192			CC73FSL1H101J	CHIP C 100PF J		
C193			CE04KW1A221M	ELECTR0 220UF 10WV		
C194			CE04KW1H010M	ELECTR0 1.0UF 50WV		
C195			CE04KW1V100M	ELECTR0 10UF 35WV		
C196, 197			CC73FCH1H330J	CHIP C 33PF J		
C198			CC73FUJ1H180J	CHIP C 18PF J		
C199			CK45FF1H103Z	CERAMIC 0.010UF Z		
C200			CC45FSL1H271J	CERAMIC 270PF J		
C201			CC45FSL1H220J	CERAMIC 22PF J		
C202			CK73FB1H103K	CHIP C 0.010UF K		
C203			CK45FF1H103Z	CERAMIC 0.010UF Z		
C204			CE04KW1A101M	ELECTR0 100UF 10WV		
C205			CE04KW1H010M	ELECTR0 1.0UF 50WV		
C206			CF92FV1H102J	MF 1000PF J		
C207, 208			CE04KW1C101M	ELECTR0 100UF 16WV		
C209			CE04HW1A470M	NP-ELEC 47UF 10WV		
C210			CC45FSL1H020C	CERAMIC 2.0PF C		
C211, 212			CE04HW1A220M	NP-ELEC 22UF 10WV		
C213, 214			CF92FV1H102J	MF 1000PF J		
C215			CK45FB1H681K	CERAMIC 680PF K		
C216, 217			CF92FV1H102J	MF 1000PF J		
C218			CK45FB1H681K	CERAMIC 680PF K		
C219			CK45FB1H391K	CERAMIC 390PF K		
C220			CC45FSL1H181J	CERAMIC 180PF J		
C221			CE04HW1A470M	NP-ELEC 47UF 10WV		
C222			CE04KW1C221M	ELECTR0 220UF 16WV		
C223, 224			CC45FSL1H101J	CERAMIC 100PF J		
C225			CF92FV1H223J	MF 0.022UF J		
C226, 227			CE04KW1V100M	ELECTR0 10UF 35WV		
C228			CC45FSL1H101J	CERAMIC 100PF J		
C229			CE04KW1HR22M	ELECTR0 0.22UF 50WV		
C230, 231			CE04KW1H010M	ELECTR0 1.0UF 50WV		
C232			CF92FV1H473J	MF 0.047UF J		
C233			CE04KW1H010M	ELECTR0 1.0UF 50WV		
C234			CE04KW1C470M	ELECTR0 47UF 16WV		
C235			CF92FV1H103J	MF 0.010UF J		
C236			CF92FV1H473J	MF 0.047UF J		
C237-249			CF92FV1H103J	MF 0.010UF J		
C251			CE04KW1V100M	ELECTR0 10UF 35WV		
C253			CE04KW1V100M	ELECTR0 10UF 35WV		
C255			CF92FV1H182J	MF 1800PF J		M
C256			CF92FV1H332J	MF 3300PF J		EMXT
C256			CF92FV1H512J	MF 5100PF J		P
C257			CF92FV1H182J	MF 1800PF J		M
C258			CF92FV1H332J	MF 3300PF J		EMXT
C258			CF92FV1H512J	MF 5100PF J		P
C260-263			CE04KW1H100M	ELECTR0 10UF 50WV		
C264, 265			CC45FSL1H101J	CERAMIC 100PF J		
C267, 268			CC45FSL1H221J	CERAMIC 220PF J		
C273			CE04KW1HOR1M	ELECTR0 0.1UF 50WV		
C274			CC45FSL1H101J	CERAMIC 100PF J		
C275			CE04HW1HR47M	NP-ELEC 0.47UF 50WV		
C277			CK45FB1H471K	CERAMIC 470PF K		
C278			CE04KW1V100M	ELECTR0 10UF 35WV		

L:Scandinavia K:USA P:Canada
Y:PX(Far East, Hawaii) T:England E:Europe
Y:AFES(Europe) X:Australia M:Other Areas

△ indicates safety critical components.

PARTS LIST

× New Parts

Parts without Parts No. are not supplied.

Les articles non mentionnés dans le Parts No. ne sont pas fournis.

Telle ohne Parts No. werden nicht geliefert.

No. 5

Ref. No.	Address	New Parts	Parts No.	Description	Destination	Remarks
参照番号	位置	新	部品番号	部品名 / 規格	仕向	備考
C280			CF92FV1H102J	MF 1000PF J		
C281			CF92FV1H473J	MF 0.047UF J		
C282			CE04KW1V100M	ELECTRØ 10UF 35WV	ET	
C283			CK45FF1H103Z	CERAMIC 0.010UF Z		
C284			CE04KW1V100M	ELECTRØ 10UF 35WV	ET	
C285			CK73FB1H103K	CHIP C 0.010UF K		
C289			CK45FF1H103Z	CERAMIC 0.010UF Z		
C290			CE04KW1H331M	ELECTRØ 330UF 50WV		
C291, 292			CK45FF1H103Z	CERAMIC 0.010UF Z		
C293			CE04KW1H331M	ELECTRØ 330UF 50WV		
C294			CE04KW1V330M	ELECTRØ 33UF 35WV		
C295			CE04KW1V471M	ELECTRØ 470UF 35WV		
C296, 297			CK45FF1H103Z	CERAMIC 0.010UF Z		
C298			CE04KW1V332M	ELECTRØ 3300UF 35WV		
C299			CE04KW1V222M	ELECTRØ 2200UF 35WV		
C300			CK45FF1H103Z	CERAMIC 0.010UF Z		
C301			CE04KW1E471M	ELECTRØ 470UF 25WV		
C302			CK45FF1H103Z	CERAMIC 0.010UF Z		
C303			CE04KW1H331M	ELECTRØ 330UF 50WV		
C304-306			CK45FF1H103Z	CERAMIC 0.010UF Z		
C307			CE04KW1H331M	ELECTRØ 330UF 50WV		
C308			CF92FV1H104J	MF 0.10UF J		
C309			CE04KW1V100M	ELECTRØ 10UF 35WV		
C310			CE04KW1V330M	ELECTRØ 33UF 35WV		
C311			CE04KW1V477M	ELECTRØ 4.7UF 35WV		
C312			CF92FV1H104J	MF 0.10UF J		
C313			CE04KW1V100M	ELECTRØ 10UF 35WV		
C314			CE04KW1C102M	ELECTRØ 1000UF 16WV		
C315, 316			CE04KW1C470M	ELECTRØ 47UF 16WV		
C317			CE04KW1C102M	ELECTRØ 1000UF 16WV		
C320			CE04KW1V470M	ELECTRØ 47UF 35WV		
C321			CC45FSL1H101J	CERAMIC 100PF J		
C322			CF92FV1H102J	MF 1000PF J		
C323, 324			CE04KW1V100M	ELECTRØ 10UF 35WV		
C325			CE04KW1A221M	ELECTRØ 220UF 10WV		
TC1			C05-0301-05	CERAMIC TRIMMER CAPACITOR(7PF)		
CN3	2C		E40-4159-05	FLAT CABLE CONNECTOR		
J1		*	E70-0041-05	LOCK TERMINAL BOARD AM ANTENNA		
J2			E13-0249-05	PHONE JACK OUTPUT		
J3			E11-0188-05	MINIATURE PHONE JACK SYNCHRO		
-			J11-0098-05	WIRE CLAMPER		
-			L39-1309-05	COMBINATION COIL		
CF1			L72-0536-05	CERAMIC FILTER	PMX	
CF1, 2			L72-0566-05	CERAMIC FILTER	ET	
CF3			L72-0120-05	CERAMIC FILTER	ET	
CF3			L72-0546-05	CERAMIC FILTER	PMX	
CF4 -6			L72-0566-05	CERAMIC FILTER	ET	
CF4, 5			L72-0536-05	CERAMIC FILTER	PMX	
CF7		*	L72-0577-05	CERAMIC FILTER	ET	
CF8			L72-0536-05	CERAMIC FILTER	PMX	
CF8			L72-0566-05	CERAMIC FILTER	ET	
CF9			L72-0572-05	CERAMIC FILTER	ET	
CF10			L72-0120-05	CERAMIC FILTER	ET	

L:Scandinavia K:USA P:Canada
Y:PX(Far East, Hawaii) T:England E:Europe
Y:AAFES(Europe) X:Australia M:Other Areas

⚠ indicates safety critical components.

× New Parts

Parts without Parts No. are not supplied.

Les articles non mentionnés dans le Parts No. ne sont pas fournis.

Telle ohne Parts No. werden nicht geliefert.

No. 6

Ref. No.	Address	New Parts	Parts No.	Description	Destination	Remarks
参照番号	位置	新	部品番号	部品名 / 規格	仕向	備考
CF10			L72-0546-05	CERAMIC FILTER	PMX	
CF12			L72-0096-05	CERAMIC FILTER		
L1			L40-2291-17	SMALL FIXED INDUCTOR		
L3, 4			L40-2291-17	SMALL FIXED INDUCTOR		
L6, 7			L31-0545-05	FM-RF COIL		
L8			L92-0017-05	FERRITE CORE		
L9			L31-0546-05	FM-RF COIL		
L11			L31-0545-05	FM-RF COIL		
L12			L40-1091-17	SMALL FIXED INDUCTOR(1UH)		
L14			L92-0017-05	FERRITE CORE		
L15			L30-0495-05	FM IFT		
L17, 18			L40-2291-17	SMALL FIXED INDUCTOR		
L20			L92-0017-05	FERRITE CORE		
L24			L30-0467-05	AM IFT		
L27 -29			L40-1001-17	SMALL FIXED INDUCTOR(10UH,K)		
L30			L30-0416-05	FM IFT		
L31			L92-0017-05	FERRITE CORE		
L32			L40-3925-29	SMALL FIXED INDUCTOR(3.9MH,J)		
L35			L30-0439-25	FM IFT		
L36			L40-1001-17	SMALL FIXED INDUCTOR(10UH,K)		
L37			L32-0527-05	FM OSCILLATING COIL		
L38			L40-6825-29	SMALL FIXED INDUCTOR(6.8MH,J)		
L39			L40-1001-17	SMALL FIXED INDUCTOR(10UH,K)		
L40			L30-0434-05	FM IFT		
L42			L32-0537-05	FM OSCILLATING COIL		
L47			L40-1091-17	SMALL FIXED INDUCTOR(1UH)		
L48			L40-2291-17	SMALL FIXED INDUCTOR		
X1			L77-1122-05	CRYSTAL RESONATOR(7.2MHZ)		
X2			L77-2002-05	CRYSTAL RESONATOR(4.332MHZ)		
X3			L78-0208-05	RESONATOR (456KHZ)	ET	
C	1B		N30-3008-46	PAN HEAD MACHINE SCREW		
R167			RS14KB3A101J	FL-PROOF RS 100 J 1W		
R176			RD14NB2E121J	RD 120 J 1/4W		
R469			RS14KB3D101J	FL-PROOF RS 100 J 2W		
VR1			R12-3685-05	TRIMMING POT.(10K) FM AUTO STP		
VR2			R12-3687-05	TRIMMING POT.(33K) AM AUTO STP		
VR4, 5			R12-3685-05	TRIMMING POT.(10K) DISTORTION		
VR6			R12-1619-05	TRIMMING POT.(4.7K) DISTORTION		
VR7, 8			R12-3685-05	TRIMMING POT.(10K) DISTORTION		
VR9			R12-0607-05	TRIMMING POT.(470) DISTORTION		
VR10-12			R12-3685-05	TRIMMING POT.(10K) DISTORTION		
VR13-15		*	R12-6664-05	TRIMMING POT.(470K) SEPARATION		
VR16			R12-3687-05	TRIMMING POT.(33K)PILOT CANCEL		
VR17			R12-6663-05	TRIMMING POT.(330K)FM AUTO STP		
W300-310			R92-0670-05	CHIP R 0 OHM		
W311-323			R92-0679-05	CHIP R 0 OHM		
W325, 326			R92-0679-05	CHIP R 0 OHM		
S1, 2			S31-2094-05	SLIDE SWITCH DE EMPHASIS	M	
D1, 2			1SV157	DIODE		
D3			HSS104	DIODE		
D3			1SS133	DIODE		
D4, 5			KV1320-5	VARIABLE CAPACITANCE DIODE		
D7			KV1320-5	VARIABLE CAPACITANCE DIODE		

L:Scandinavia K:USA P:Canada
Y:PX(Far East, Hawaii) T:England E:Europe
Y:AAFES(Europe) X:Australia M:Other Areas

⚠ indicates safety critical components.

PARTS LIST

KT-6050

× New Parts

Parts without Parts No. are not supplied.

Les articles non mentionnés dans le Parts No. ne sont pas fournis.

Teile ohne Parts No. werden nicht geliefert.

No. 7

Ref. No. 参照番号	Address 位置	New Parts 新	Parts No. 部品番号	Description 部品名/規格	Desti- nation 仕向	Re- marks 備考
D9 ,10			KV1320-5	VARIABLE CAPACITANCE DIODE		
D11 -15			HSS104	DIODE	PMX	
D11 -15			1SS133	DIODE	PMX	
D11 -31			HSS104	DIODE	ET	
D11 -31			1SS133	DIODE	ET	
D20 ,21			HSS104	DIODE	PMX	
D20 ,21			1SS133	DIODE	PMX	
D24 -30			HSS104	DIODE	PMX	
D24 -30			1SS133	DIODE	PMX	
D37 -40			HSS104	DIODE		
D37 -40			1SS133	DIODE		
D41			HZS8.2S(B2)	ZENER DIODE		
D41			RD8.2JS(B2)	ZENER DIODE		
D42 ,43			KV1320-2	VARIABLE CAPACITANCE DIODE		
D44 -47			HSS104	DIODE		
D44 -47			1SS133	DIODE		
D48			HZS5.1S(B2)	ZENER DIODE		
D48			RD5.1JS(B2)	ZENER DIODE		
D49 -58			HSS104	DIODE		
D49 -58			1SS133	DIODE		
D60			HSS104	DIODE	ET	
D60			1SS133	DIODE	ET	
D61 -63			S5688B	DIODE		
D61 -63			1SR139-100	DIODE		
D64			HZS8.2S(B2)	ZENER DIODE		
D64			RD8.2JS(B2)	ZENER DIODE		
D65			HZS20S(B2)	ZENER DIODE		
D65			RD20JS(B2)	ZENER DIODE		
D66			S5688B	DIODE		
D66			1SR139-100	DIODE		
D67			HSS104	DIODE		
D67			1SS133	DIODE		
D68 -73			S5688B	DIODE		
D68 -73			1SR139-100	DIODE		
D74 ,75			HZS8.2S(B2)	ZENER DIODE		
D74 ,75			RD8.2JS(B2)	ZENER DIODE		
D76			S5688B	DIODE		
D76			1SR139-100	DIODE		
D77 -79			HZS5.1S(B2)	ZENER DIODE		
D77 -79			RD5.1JS(B2)	ZENER DIODE		
D80 -82			HSS104	DIODE		
D80 -82			1SS133	DIODE		
D83			HZS6.8N(B2)	ZENER DIODE		
D83			RD6.8ES(B2)	ZENER DIODE		
D84			HSS104	DIODE		
D84			1SS133	DIODE		
D86 -90			HSS104	DIODE		
D86 -90			1SS133	DIODE		
D91			HZS3.9N(B2)	ZENER DIODE		
D91			RD3.9ES(B2)	ZENER DIODE		
D92 -94			HSS104	DIODE	ET	
D92 -94			1SS133	DIODE	ET	
D94			HSS104	DIODE	PMX	
D94			1SS133	DIODE	PMX	
D95			HZS5.1S(B2)	ZENER DIODE		

L:Scandinavia K:USA P:Canada
Y:FX(Far East, Hawaii) T:England E:Europe
Y:AFES(Europe) X:Australia M:Other Areas

△ indicates safety critical components.

× New Parts

Parts without Parts No. are not supplied.

Les articles non mentionnés dans le Parts No. ne sont pas fournis.

Teile ohne Parts No. werden nicht geliefert.

No. 8

Ref. No. 参照番号	Address 位置	New Parts 新	Parts No. 部品番号	Description 部品名/規格	Desti- nation 仕向	Re- marks 備考
D95			RD5.1JS(B2)	ZENER DIODE		
D100-103			HSS104	DIODE	ET	
D100-103			1SS133	DIODE	ET	
IC1			NJM4565D	IC(OP AMP X2)		
IC3			NJM4568D	IC(OP AMP X2)		
IC4			LA1267	IC(AM/FM TUNER)		
IC5 ,6			NJM4200D	IC(OP AMP X2)		
IC7 -9			NJM4565D	IC(OP AMP X2)		
IC10			NJM4560D-A	IC(OP AMP X2)		
IC11			NJM4565D	IC(OP AMP X2)		
IC12			LM7001	IC(PLL FREQUENCY SYNTHESIZER)		
IC13			TDA7330B	IC(RDS DEMODULATOR)	ET	
IC14			NJM4558D	IC(OP AMP X2)		
IC15			NJM4565D	IC(OP AMP X2)		
IC16			LA3450	IC(MPX)		
IC17			NJM4565D	IC(OP AMP X2)		
IC18			TA7302P	IC(FM IF)		
IC19-23			NJM4565D	IC(OP AMP X2)		
IC25-29			NJM4565D	IC(OP AMP X2)		
IC30			TA7805S	IC(VOLTAGE REGULATOR/ +5V)		
IC30			UPC7805AHF	IC(VOLTAGE REGULATOR/ +5V)		
IC31-33			NJM4565D	IC(OP AMP X2)		
Q1			2SA1037K	TRANSISTOR		
Q2			2SC2412K	TRANSISTOR		
Q3			2SK302(Y,GR)	FET		
Q4			3SK226	FET		
Q5			2SK302(Y,GR)	FET		
Q6			3SK151(GR)	FET		
Q7			2SK302(Y,GR)	FET		
Q8 -11			2SC2714(R,0)	TRANSISTOR		
Q12			2SK302(Y,GR)	FET		
Q13 ,14			2SC2714(R,0)	TRANSISTOR		
Q15 ,16			DTA124EK	DIGITAL TRANSISTOR	ET	
Q17			DTL114TK	DIGITAL TRANSISTOR	ET	
Q18 -20			2SC2714(R,0)	TRANSISTOR		
Q21 ,22			DTA124EK	DIGITAL TRANSISTOR	ET	
Q23 -28			2SC2714(R,0)	TRANSISTOR		
Q29 ,30			2SA1037K	TRANSISTOR		
Q51			2SK709(BL,V)	FET		
Q52			2SC3940A(R,S)	TRANSISTOR		
Q53			2SD2012	TRANSISTOR		
Q54			2SC2458(Y,GR)	TRANSISTOR		
Q54			2SC3311A(Q,R)	TRANSISTOR		
Q55			2SA1534A(R,S)	TRANSISTOR		
Q57			2SK246(Y,GR)	FET		
Q58			2SC2458(Y,GR)	TRANSISTOR		
Q58			2SC3311A(Q,R)	TRANSISTOR		
Q59			2SA1048(Y,GR)	TRANSISTOR		
Q59			2SA1309A(Q,R)	TRANSISTOR		
Q62			DTA124ES	DIGITAL TRANSISTOR		
Q63			2SK163(M)	FET		
Q64 ,65			2SK161(GR)	FET		
Q66 -72			2SK246(Y,GR)	FET		
Q73			2SC2458(Y,GR)	TRANSISTOR		
Q73			2SC3311A(Q,R)	TRANSISTOR		

L:Scandinavia K:USA P:Canada
Y:FX(Far East, Hawaii) T:England E:Europe
Y:AFES(Europe) X:Australia M:Other Areas

△ indicates safety critical components.

× New Parts

Parts without Parts No. are not supplied

Les articles non mentionnés dans le Parts No. ne sont pas fournis.

Teile ohne Parts No. werden nicht geliefert.

No. 9

Ref. No. 参照番号	Address 位置	New Parts	Parts No. 部品番号	Description 部品名/規格	Desti- nation 仕向	Re- marks 備考
Q77			2SC2458(Y,GR)	TRANSISTOR		
Q77			2SC3311A(Q,R)	TRANSISTOR		
Q78 -81			2SC2878(B)	TRANSISTOR		
Q82			2SA1048(Y,GR)	TRANSISTOR		
Q82			2SA1309A(Q,R)	TRANSISTOR		
Q83			DTC124ES	DIGITAL TRANSISTOR		
Q84			2SC2458(Y,GR)	TRANSISTOR		
Q84			2SC3311A(Q,R)	TRANSISTOR		
Q85			2SA1048(Y,GR)	TRANSISTOR	ET	
Q85			2SA1309A(Q,R)	TRANSISTOR	ET	
Q86 ,87			DTA124ES	DIGITAL TRANSISTOR		
Q88			2SK246(Y,GR)	FET		
Q89			2SD2012	TRANSISTOR		
Q90			2SC2458(Y,GR)	TRANSISTOR		
Q90			2SC3311A(Q,R)	TRANSISTOR		
Q91			2SK246(Y,GR)	FET		
Q92			2SD2012	TRANSISTOR		
Q93 ,94			2SC2458(Y,GR)	TRANSISTOR		
Q93 ,94			2SC3311A(Q,R)	TRANSISTOR		
Q95			DTC124ES	DIGITAL TRANSISTOR		
Q96			2SK246(Y,GR)	FET		
Q97			2SA1048(Y,GR)	TRANSISTOR		
Q97			2SA1309A(Q,R)	TRANSISTOR		
Q98			2SB1375	TRANSISTOR		
Q99			2SK246(Y,GR)	FET		
Q100			2SA1534A(R,S)	TRANSISTOR		
Q101			2SA1048(Y,GR)	TRANSISTOR		
Q101			2SA1309A(Q,R)	TRANSISTOR		
Q102			DTC124ES	DIGITAL TRANSISTOR		
Q103			2SK246(Y,GR)	FET		
Q104			DTA124ES	DIGITAL TRANSISTOR		
Q105			2SC2458(Y,GR)	TRANSISTOR		
Q105			2SC3311A(Q,R)	TRANSISTOR		
J4		*	W02-1175-05	ELECTRIC CIRCUIT MODULE		
ACCESSORIES UNIT (X13-727X-XX)						
D18			B30-1012-05	LED(SLP-981C-S1)		
D26 -28			B30-1012-05	LED(SLP-981C-S1)		
C1 -3			CC73FSL1H221J	CHIP C 220PF J		
C4 ,5			CK73FB1H102K	CHIP C 1000PF K		
C6 -8			CC73FSL1H221J	CHIP C 220PF J		
C9 ,10			CK73FB1H102K	CHIP C 1000PF K		
C11			CC73FSL1H221J	CHIP C 220PF J		
C12 ,13			CK73FB1H102K	CHIP C 1000PF K		
C14 -17			CK73FF1H223Z	CHIP C 0.022UF Z		
C19 -23			CK73FB1H102K	CHIP C 1000PF K		
C24			CK73FB1H103K	CHIP C 0.010UF K		
C25			CK73FB1H102K	CHIP C 1000PF K		
C26 ,27			CK73FF1H473Z	CHIP C 0.047UF Z		
C29			CF92FV1H102J	MF 1000PF J		
C30			C90-3251-05	ELECTRO 0.47UF 50WV		
C31 ,32			CK73FB1H681K	CHIP C 680PF K		
C33			CF92FV1H103J	MF 0.010UF J		
C34 ,35			CF92FV1H222J	MF 2200PF J		

L:Scandinavia K:USA P:Canada
Y:PX(Far East, Hawaii) T:England E:Europe
Y:AAFES(Europe) X:Australia M:Other Areas

⚠ indicates safety critical components.

× New Parts

Parts without Parts No. are not supplied.

Les articles non mentionnés dans le Parts No. ne sont pas fournis.

Teile ohne Parts No. werden nicht geliefert.

No. 10

Ref. No. 参照番号	Address 位置	New Parts	Parts No. 部品番号	Description 部品名/規格	Desti- nation 仕向	Re- marks 備考
C36			CK73FB1H103K	CHIP C 0.010UF K		
C37			CK73FB1H102K	CHIP C 1000PF K		
C38 -40			CC73FSL1H221J	CHIP C 220PF J	ET	
C41			CK73FB1H102K	CHIP C 1000PF K	ET	
C42			CK73FB1H103K	CHIP C 0.010UF K		
C43			C90-1827-05	BACKUP 0.047F 5.5WV		
C44			C90-3214-05	ELECTRO 100UF 6.3WV		
C45			CK73FB1H102K	CHIP C 1000PF K		
C46			C90-3214-05	ELECTRO 100UF 6.3WV		
C47			CK73FB1H103K	CHIP C 0.010UF K	ET	
C48			C90-3209-05	ELECTRO 10UF 6.3WV	ET	
C49 -51			CC73FSL1H221J	CHIP C 220PF J	ET	
C52			C90-3214-05	ELECTRO 100UF 6.3WV		
C53 -60			CK73FB1H102K	CHIP C 1000PF K		
CN1	2B		E40-4199-05	FLAT CABLE CONNECTOR		
L1 ,2			L40-1001-17	SMALL FIXED INDUCTOR(10UH,K)	ET	
L2			L40-1001-17	SMALL FIXED INDUCTOR(10UH,K)	PMX	
X1			L78-0267-05	RESONATOR (4.194MHZ)		
X2			L78-0503-05	RESONATOR (4.00MHZ)	ET	
CP1			R90-0493-05	MULTI-COMP 100KX9 J 1/6W		
CP2			R90-0492-05	MULTI-COMP 100KX8 J 1/6W		
CP3			R90-0803-05	MULTI-COMP 100KX7 J 1/4W		
R23			R92-0173-05	RC 2.2M M 1/2W	P	
W12 -14			R92-0679-05	CHIP R 0 OHM		
W68 -70			R92-0679-05	CHIP R 0 OHM		
W72 ,73			R92-0670-05	CHIP R 0 OHM		
W74 -78			R92-0679-05	CHIP R 0 OHM		
W79			R92-0670-05	CHIP R 0 OHM		
W82 -85			R92-0679-05	CHIP R 0 OHM		
W86			R92-0670-05	CHIP R 0 OHM		
W87			R92-0679-05	CHIP R 0 OHM		
W88 ,89			R92-0670-05	CHIP R 0 OHM		
W90			R92-0679-05	CHIP R 0 OHM		
W91 ,92			R92-0670-05	CHIP R 0 OHM		
W101			R92-0670-05	CHIP R 0 OHM		
S1 -25			S40-1064-05	PUSH SWITCH KEY BOARD	ET	
S1 -4			S40-1064-05	PUSH SWITCH KEY BOARD	PMX	
S6			S40-1064-05	PUSH SWITCH IF BAND	PMX	
S8			S40-1064-05	PUSH SWITCH ACTIVE RECEPTION	PMX	
S10 -25			S40-1064-05	PUSH SWITCH KEY BOARD	PMX	
⚠ S27			S62-0001-05	SLIDE SWITCH VOLTAGE SELECTOR	M	
S26			T99-0522-05	SPEED DETECTOR TUNING,PTY SEL		
D1 -17			HSS104	DIODE		
D1 -17			ISS133	DIODE		
D19 ,20			HSS104	DIODE		
D19 ,20			ISS133	DIODE		
D23 -25			HSS104	DIODE	P	
D23 -25			ISS133	DIODE	P	
D24 ,25			HSS104	DIODE	MX	
D24 ,25			ISS133	DIODE	MX	
D25			HSS104	DIODE	ET	
D25			ISS133	DIODE	ET	

L:Scandinavia K:USA P:Canada
Y:PX(Far East, Hawaii) T:England E:Europe
Y:AAFES(Europe) X:Australia M:Other Areas

⚠ indicates safety critical components.

PARTS LIST

KT-6050

* New Parts

Parts without Parts No. are not supplied.

Les articles non mentionnés dans le Parts No. ne sont pas fournis.

Teile ohne Parts No. werden nicht geliefert.

No. 11

Ref. No. 参照番号	Address 位置	New Parts 新	Parts No. 部品番号	Description 部品名 / 規格	Desti- nation 仕向	Re- marks 備考
D29	.30		HSS104	DIODE		
D29	.30		1SS133	DIODE		
D32			HSS104	DIODE	M	
Q32			1SS133	DIODE	M	
ED1		*	FIP12CKM7	INDICATOR TUBE		
IC1		*	UPD78044GF-043	IC(8 bit MICROPROCESSOR)		
IC2			LC6543H-4600	IC(RDS DECODER)	ET	
IC3			S-80740AL	IC(VOLTAGE DETECTOR)		
IC4			UPD4069UBC	IC(INVERTER X6)		
Q1	-3		2SC2412K	TRANSISTOR		
Q4			2SA1037K	TRANSISTOR	ET	
Q5			2SC2412K	TRANSISTOR		
Q6			2SA1037K	TRANSISTOR		
Q7			DTA143EK	DIGITAL TRANSISTOR	M	
Q8			2SA1037K	TRANSISTOR		
Q9			2SC2412K	TRANSISTOR		
A1			W02-0975-05	ELECTRIC CIRCUIT MODULE		

L:Scandinavia

K:USA

P:Canada

Y:PX(Far East, Hawaii)

T:England

E:Europe

Y:AFES(Europe)

X:Australia

M:Other Areas

△ indicates safety critical components.

KT-6050

PARTS LIST

KT-6050

SPECIFICATIONS

For U.S.A. and General market

[FM tuner section]

Reception frequency range	87.5 MHz - 108 MHz
Usable sensitivity (MONO at 75 Ω)	0.95 μV/10.8 dBf(1.4 μV)
50 dB quieting sensitivity (at 75 Ω)	
MONO	2.3 μV/ 18.5 dBf
STEREO	32 μV/ 41.2 dBf
Total harmonic distortion (at 1 kHz)	
MONO	0.007 % (85 dBf input) WIDE
STEREO	0.025 % (85 dBf input) WIDE
Signal to noise ratio (at 1 kHz)	
MONO	92 dB (85 dBf input)
STEREO	85 dB (85 dBf input)
Stereo separation	
1 kHz	60 dB (WIDE)
50 Hz - 10 kHz	50 dB (WIDE)
Capture ratio	1.0 dB (WIDE)
	2.0 dB (NARROW)
Selectivity (± 400 kHz)	60 dB (WIDE)
Image rejection ratio (at 98 MHz)	90 dB
IF rejection ratio (at 98 MHz)	110 dB
Spurious rejection ratio (at 98 MHz)	100 dB
AM suppression ratio	68 dB
Frequency response (30 Hz - 15 kHz)	+0.5 dB, -0.7 dB
Output level/Impedance (at 1 kHz, 75 kHz dev)	
Fixed	0.8 V/600 Ω

[AM tuner section]

Reception frequency range	
9 kHz step	531 kHz - 1,602 kHz
10 kHz step	530 kHz - 1,610 kHz or 530 kHz - 1,700 kHz (P Type)
Usable sensitivity	10 μV/(300 μV/m)
Signal to noise ratio (at 30 % mod. 1 mV input)	50 dB
Total harmonic distortion	0.3 %
Image rejection ratio	37 dB
Selectivity	30 dB
Output level/Impedance (at 30 % mod. 1 mV input)	0.24 V/600 Ω

[General]

Power consumption	25W
Dimensions	W: 440 mm (17.3") H: 98 mm (3.8") D: 331 mm (13.0")
Weight (Net)	4.5 kg (9.9 lb)

For U.K. and Europe

[FM tuner section]

Reception frequency range	87.5 MHz - 108 MHz
Usable sensitivity (DIN at 75 Ω)	
MONO	0.95 μV/10.8 dBf
STEREO	35 μV/42 dBf
Limiting level (DIN at 75 Ω)	0.64 μV/7.3 dBf
Total harmonic distortion (DIN at 1 kHz)	
MONO	0.009 % (85.2 dBf) WIDE
STEREO	0.025 % (85.2 dBf) WIDE
Signal to noise ratio (DIN weighted at 1 kHz)	
MONO	83 dB (85.2 dBf input)
STEREO	76 dB (85.2 dBf input)
Stereo separation (DIN)	
1 kHz	60 dB (WIDE)
6.3 kHz	50 dB (WIDE)
Capture ratio	1.5 dB (WIDE)
Selectivity (DIN ± 300 kHz)	50 dB (WIDE)
(DIN ± 200 kHz)	60 dB (NARROW)
Image rejection ratio (at 98 MHz)	90 dB
IF rejection ratio (at 98 MHz)	110 dB
Spurious rejection ratio (at 98 MHz)	100 dB
AM suppression ratio	68 dB
Sub carrier suppression (DIN)	76 dB (at 19 kHz) 70 dB (at 38 kHz)
Frequency response (30 Hz - 15 kHz)	+0.5 dB, -1.0 dB
Output level/Impedance (FM at 1 kHz, 75 kHz dev)	
Fixed	0.8 V/600 Ω

[MW tuner section]

Reception frequency range	531 kHz - 1,602 kHz
Usable sensitivity	10 μV/(300 μV/m)
Signal to noise ratio (at 30 % mod. 1 mV input)	50 dB
Total harmonic distortion	0.3 %
Image rejection ratio	37 dB
Selectivity	30 dB
Output level/Impedance (at 30 % mod. 1 mV input)	0.24 V/600 Ω

[General]

Power consumption	25W
Dimensions	W: 440 mm (17-5/16") H: 98 mm (3-7/8") D: 331 mm (13-1/16")
Weight (Net)	4.5 kg (9.9 lb)

KENWOOD CORPORATION

Alive Mitake, 2-5, 1-chome Shibuya, Shibuya-ku, Tokyo 150, Japan

KENWOOD SERVICE CORPORATION

PO BOX 22745, 2201 East Dominguez St., Long Beach, CA 90801-5745, U.S.A.

KENWOOD ELECTRONICS CANADA INC.

6070 Kestrel Road, Mississauga, Ontario, Canada L5T 1S8

KENWOOD ELECTRONICS LATIN AMERICA S.A.

P.O. BOX 55-2791, Piso 6 Plaza Chase, Cl. 47 y Aquilino de la Guardia, Panama, Republic of Panama

TRIO-KENWOOD U.K. LIMITED

Kenwood House, Dwight Road, Watford, Herts, WD1 8EB, United Kingdom

KENWOOD ELECTRONICS BENELUX N.V.

Mechelsesteenweg 418 B-1930 Zaventem, Belgium

KENWOOD ELECTRONICS DEUTSCHLAND GMBH

Rembrucker Str. 15, 63150 Heusenstamm, Germany

TRIO-KENWOOD FRANCE S.A.

13 Boulevard Ney, 75018 Paris, France

KENWOOD ELECTRONICS ITALIA S.p.A.

Via G. Sirtori, 7/9 20129 Milano, Italy

KENWOOD ESPANA S.A.

Bolivia, 239-08020 Barcelona, Spain

KENWOOD ELECTRONICS AUSTRALIA PTY. LTD. (A.C.T.) 001 499 074

PO BOX 504, 8 Figtree Drive, Australia Centre, Homebush, N.S.W. 2140, Australia

KENWOOD & LEE ELECTRONICS, LTD.

Unit 37/12-37/24, Level 37 Tower 1, Metroplaza, 223 Hing Fong Road,

Kwai Fong N.T. Hong Kong

KENWOOD ELECTRONICS SINGAPORE PTE LTD

No. 1 Genting Lane #07-00, KENWOOD Building, Singapore 1334

KENWOOD follows a policy of continuous advancements in development.
For this reason specifications may be changed without notice.

KENWOOD poursuit une politique de progrès constants en ce qui concerne le développement.
Pour cette raison, les spécifications sont sujettes à modifications sans préavis.

KENWOOD strebt ständige Verbesserungen in der Entwicklung an.
Daher bleiben Änderungen der technischen Daten jederzeit vorbehalten.

Note:

Component and circuitry are subject to modification to insure best operation under differing local conditions. This manual is based on the U.S.A. (K) standard, and provides information on regional circuit modification through use of alternate schematic diagrams, and information on regional component variations through use of parts list.