

# NEC

Authentic series

MODEL AUT-8300E (BG)

## STEREO TUNER SERVICE MANUAL



Better Service  
Better Reputation  
Better Profit

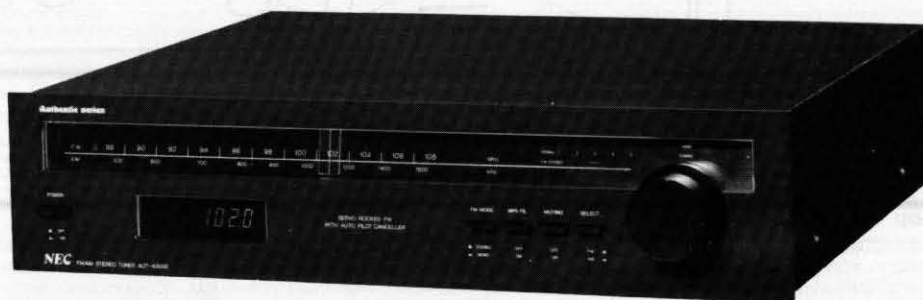

### SPECIFICATIONS

FM SECTION	NOMINAL VALUE
Tuning Frequency Range	8.7 ~ 108 MHz
Usable Sensitivity	10.3 dBf (1.8 $\mu$ V)
50 dB Quieting Sensitivity	
Monaural	16.1 dBf (3.5 $\mu$ V)
Stereo	38.5 dBf (45 $\mu$ V)
Signal to noise Ratio	.80 dB (Monaural)
Capture Ratio	1.0 dB
Alternate Channel Selectivity	.80 dB
Image Rejection Ratio	.80 dB
I.F. Rejection Ratio	.90 dB
Spurious Response Ratio	100 dB
Total Harmonic Distortion	
Monaural	0.08 %
Stereo	0.15 %
Stereo Separation	45 dB at 1 KHz

AM SECTION	NOMINAL VALUE
Tuning Frequency Range	.525 ~ 1,605 KHz
Usable Sensitivity	.250 $\mu$ V/m
Signal to Noise Ratio	.50 dB
Selectivity	.30 dB

### OTHER SPECIFICATIONS

Output Level/Impedance	FIXED	VARIABLE	
FM (1 KHz 100% modulation)	.0.7V/4.7K $\Omega$	0~1.4V/4.7K $\Omega$	
AM (400 Hz 30% modulation)	.0.2V/4.7K $\Omega$	0~0.4V/4.7K $\Omega$	
Power Supply			
TYPE	BC	BA	BG
Voltage (V AC)	120	240	110/120/220/240
Hertz	60	50	50/60
Dimension	450 (W) x 100 (H) x 340 (D) mm		
Weight	Approximately 8 kgs.		

Nippon Electric Co., Ltd.

TOKYO, JAPAN

## DISASSEMBLY INSTRUCTIONS

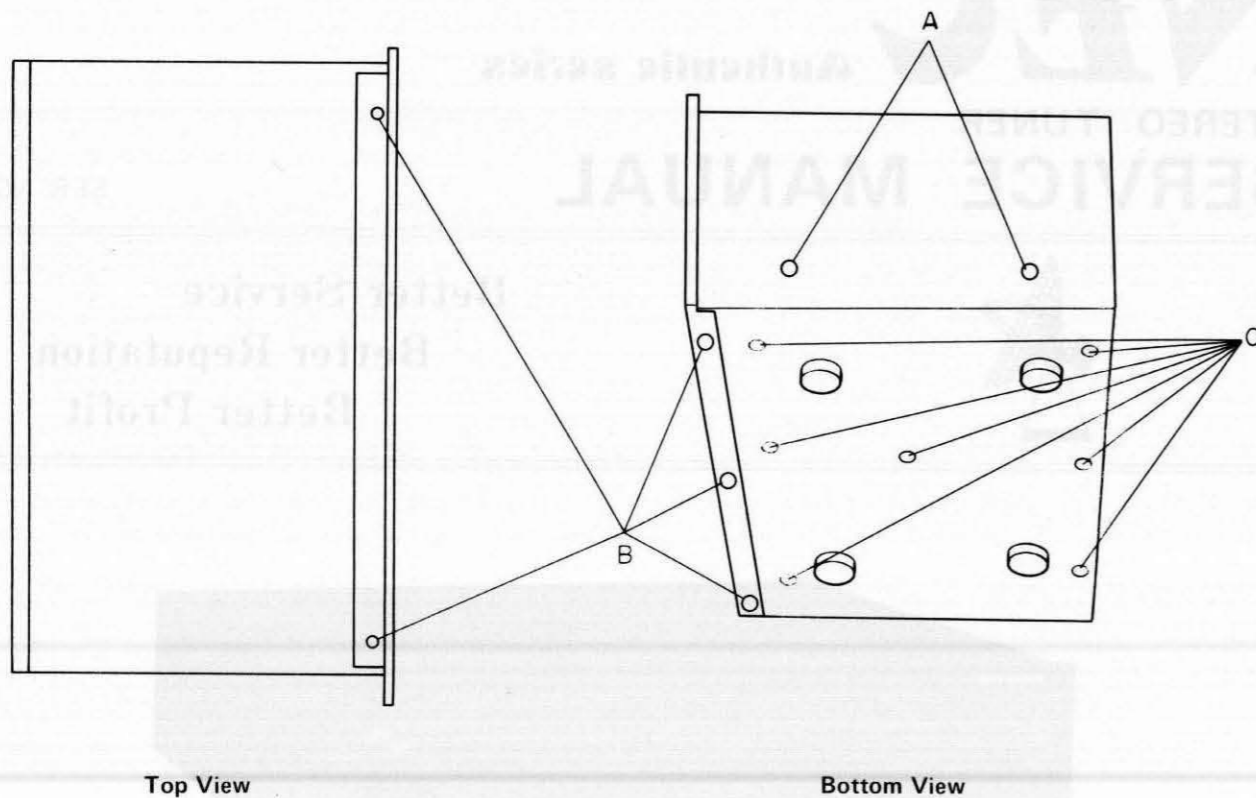

Fig. 1

### Removing cabinet top and bottom cover. See Fig. 1.

1. Remove 4 cabinet screws (A) from left and right sides and lift off cabinet.
2. Remove seven bottom cover screws (C) and lift off bottom cover.

### Removing front panel. See Fig. 1.

1. Remove 5 screws (B) from chassis and lift off front panel.

## ALIGNMENT METHOD

**NOTE:** In FM alignment, keep P205, 15-16 short-circuited and AFC turned OFF.

### FM IF Alignment (Fig. 2)

- (1) Function Switch : "FM"
- (2) Muting Switch : "OFF"
- (3) MPX Filter Switch : "OFF"
- (4) FM Mode Switch : "AUTO"

#### 1. Selectivity Curve Alignment (To use IF Sweep Generator & Oscilloscope)

Alignment Point	Alignment Method	Signal Input Point	Signal Output Point
IFT T1	Save Height max., Symmetric	C106 ↔ P101 - 3 TC5 ↔ Shield case (GND)	P117 ↔ P104 - P (GND) TP2 ↔ P101 - 2 (GND)

Alignment to be done with weak input signal.

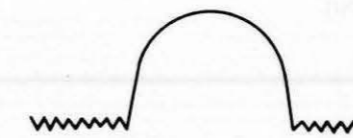

Example of Scope Wave Form

Fig. 2

#### 2. S curve alignment (Fig. 3) (To use IF Sweep Generator & Oscilloscope)

Alignment Point	Alignment Method	Signal Input Point	Signal Output Point
T101 (A)	To align at optimal point of linearity	TC5 ↔ Shield case (GND)	P101 ↔ P104 - 6 (GND) TP1 ↔ P101 - 2 (GND)
T101 (A)	Set pointer to 0 V of volt-meter.	No signal	Each end of R119. Refer to Fig. 4.

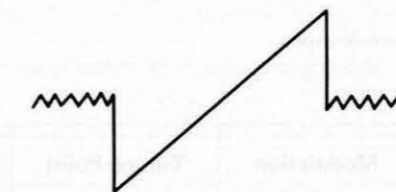

Example of Scope Wave

Fig. 3

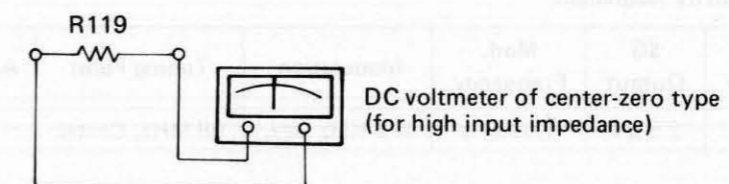
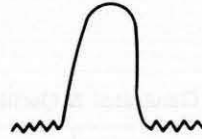

Fig. 4

## AM IF Alignment (Fig. 5) (To use IF Sweep Generator & Oscilloscope)

(1) Function Switch : "AM"

Alignment Point	Alignment Method	Signal Input Point	Signal Output Point
T102, T103	Wave Height max., Symmetric	Ext. AM Ant. Terminal	TP3 ↔ P104 – 2 (GND)



Example of Wave Form

Fig. 5

**NOTE:** (1) The connection to TP3 to be cut with a film capacitor 0.47 ~ 1 μF.  
 (2) Alignment to be done with weak input.

## FM Alignment

Position of switches are just the same as in the FM IF Alignment.

### 1. Alignment of receiving frequency range

SSG Frequency	VC Position	Alignment Point	Alignment Method	Signal Input Point	Signal Output Point
108 MHz	108 MHz tuning point	TC6	In receiving Position	Antenna Terminal	Output Jacks

### 2. Tracking alignment

SSG Frequency	VC Position	Alignment Point	Alignment Method	Signal Input Point	Signal Output Point
106 MHz	106 MHz tuning point	TC1, TC2, TC3	To have max. Sensitivity	Antenna Terminal	Output Jacks

**NOTE:** Alignment to be done with very weak input

### 3. Distortion alignment

SSG Frequency	SG Output	Mod. Frequency	Modulation	Tuning Point	Alignment Point	Signal Output Point
98 MHz	1 mV	1,000 Hz	±75 KHz Dev.	98 MHz, Center	T101-B	Output Jacks

**NOTE:** Adjust T101B core for optimal distortion point.

### 4. Muting sensitivity Alignment

SSG Frequency	SG Output	Mod. Frequency	Modulation	Tuning Point	Alignment Point	Signal Output Point
98 MHz	2.5 μV	1,000 Hz	±75 KHz Dev.	98 MHz, Center	VR101	Output Jacks

Alignment Method: Muting release point.

**NOTE:** Muting SW "ON" Position

## 5. FM stereo alignment

(1) VCO Alignment

**NOTE:** J126 ↔ J127 (with input short-circuited), put buffer amplifier in-between TP4 and Counter.

(2) Pilot Cancel Alignment

(3) Separation Alignment

**NOTE:** Alignment to be done with weak input.

	SSG Frequency	SG Output	Mod. Frequency	Tuning Point	Alignment Point	Alignment Method	Signal Output Point	Needed Equipment	Modulation
(1)	98 MHz				VR102	Adjust OSC Freq. to 76 KHz	TP4 ↔ J127 (GND)	Frequency Counter	0
(2)	98 MHz	1 mV	Pilot 19±6.75KHz	98 MHz	VR103	Output min.	Output Jacks	<b>NOTE:</b> Keep L and R well-balanced.	
(3)	98 MHz	1 mV	Stereo 1±6.75KHz 19±6.75KHz	98 MHz	VR104	Adjust separation for L and R over 45 dB.	Output Jacks		

## 6. FM signal meter alignment

SSG Frequency	SG Output	Tuning Point	Alignment Point	Signal Output Point	Alignment Method
98 MHz	200 μV	98 MHz	VR252	Output Jacks	Signal LEDs 1 to 5 light up.

### AM signal meter alignment

SSG Frequency	SG Output	Tuning Point	Alignment Point	Signal Output Point	Alignment Method
1,000 KHz	Approx. 1.5 mV	1,000 KHz	VR253	Output Jacks	Signal LED 1 only lights up.

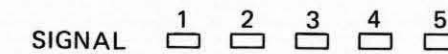

Fig. 6

## AM RF Alignment

Function SW; "AM" Position

### 1. Receiving frequency range alignment

SSG Frequency	VC Position	Alignment Point	Signal Input Point	Signal Output Point	Alignment Method
515 KHz	Capacitance max.	L109	Bar Antenna	Output Jacks	In receiving Position
1700 KHz	Capacitance min.	TC5			

### 2. Tracking alignment

SSG Frequency	VC Position	Alignment Point	Signal Input Point	Signal Output Point	Alignment Method
600 KHz	Tuning Point	Bar Antenna Coil	Bar Antenna	Output Jacks	To have Sensitivity max.
1400 KHz		TC4			

## ALIGNMENT POINT DIAGRAMS

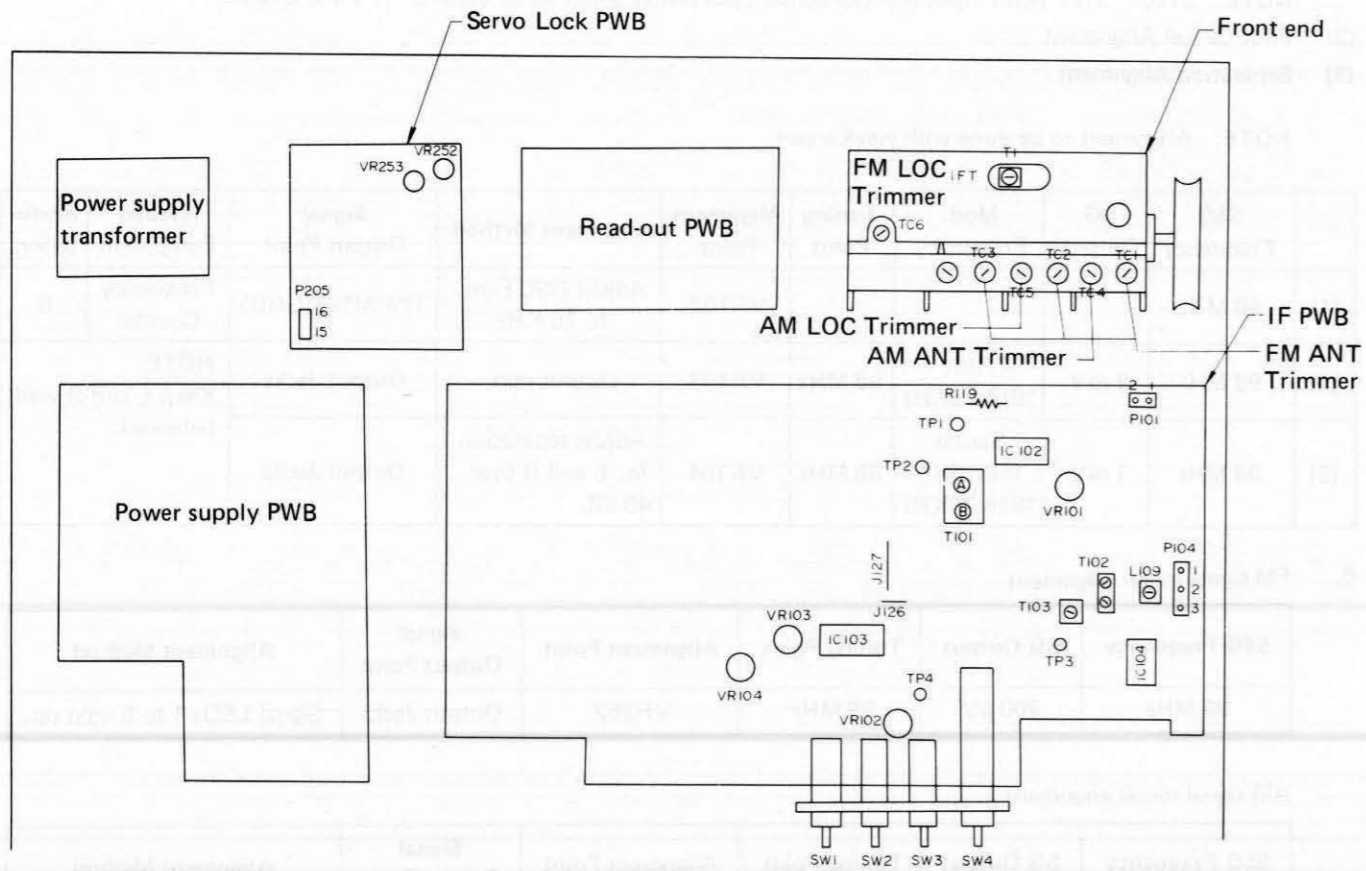

Fig. 7

## FM EQUIPMENT CONNECTION DIAGRAMS

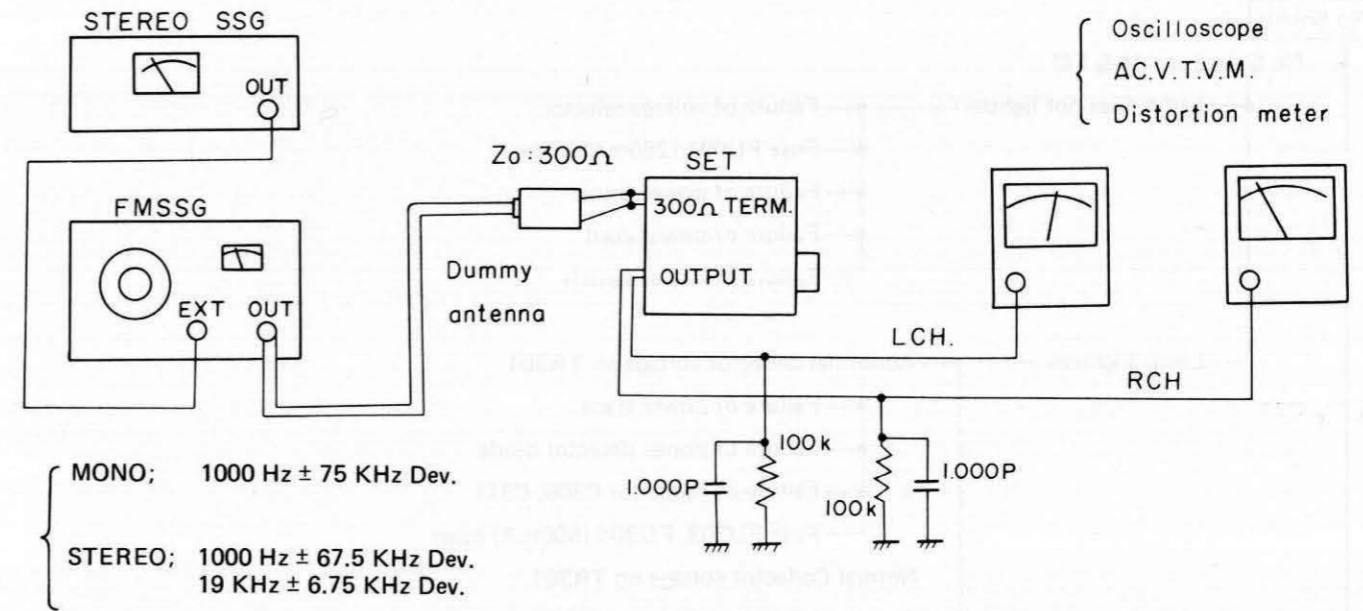

Fig. 8

## AM EQUIPMENT CONNECTION DIAGRAMS OSCILLOSCOPE

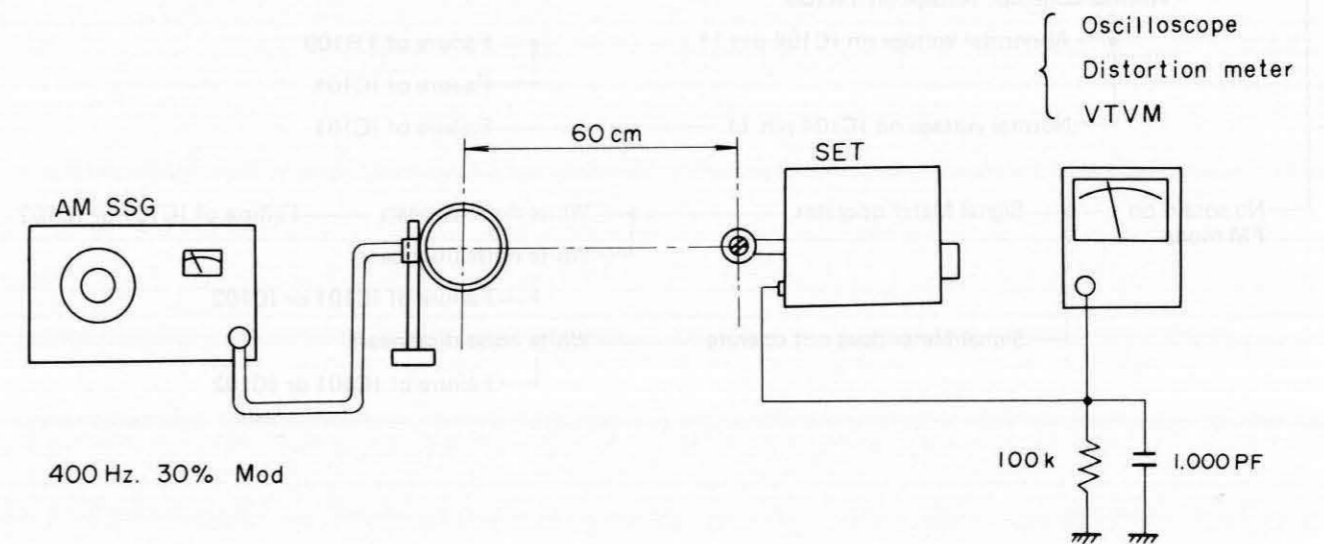
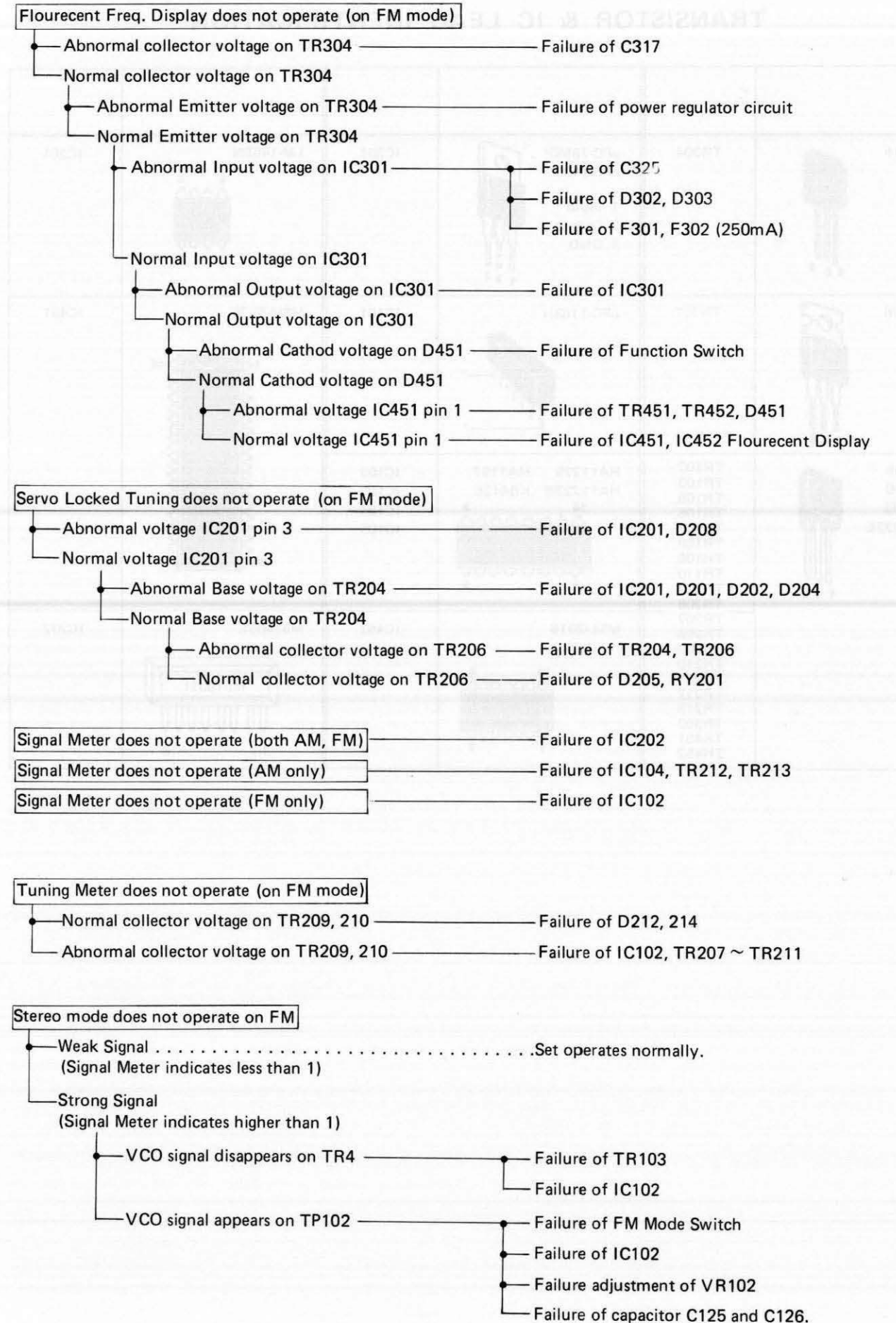
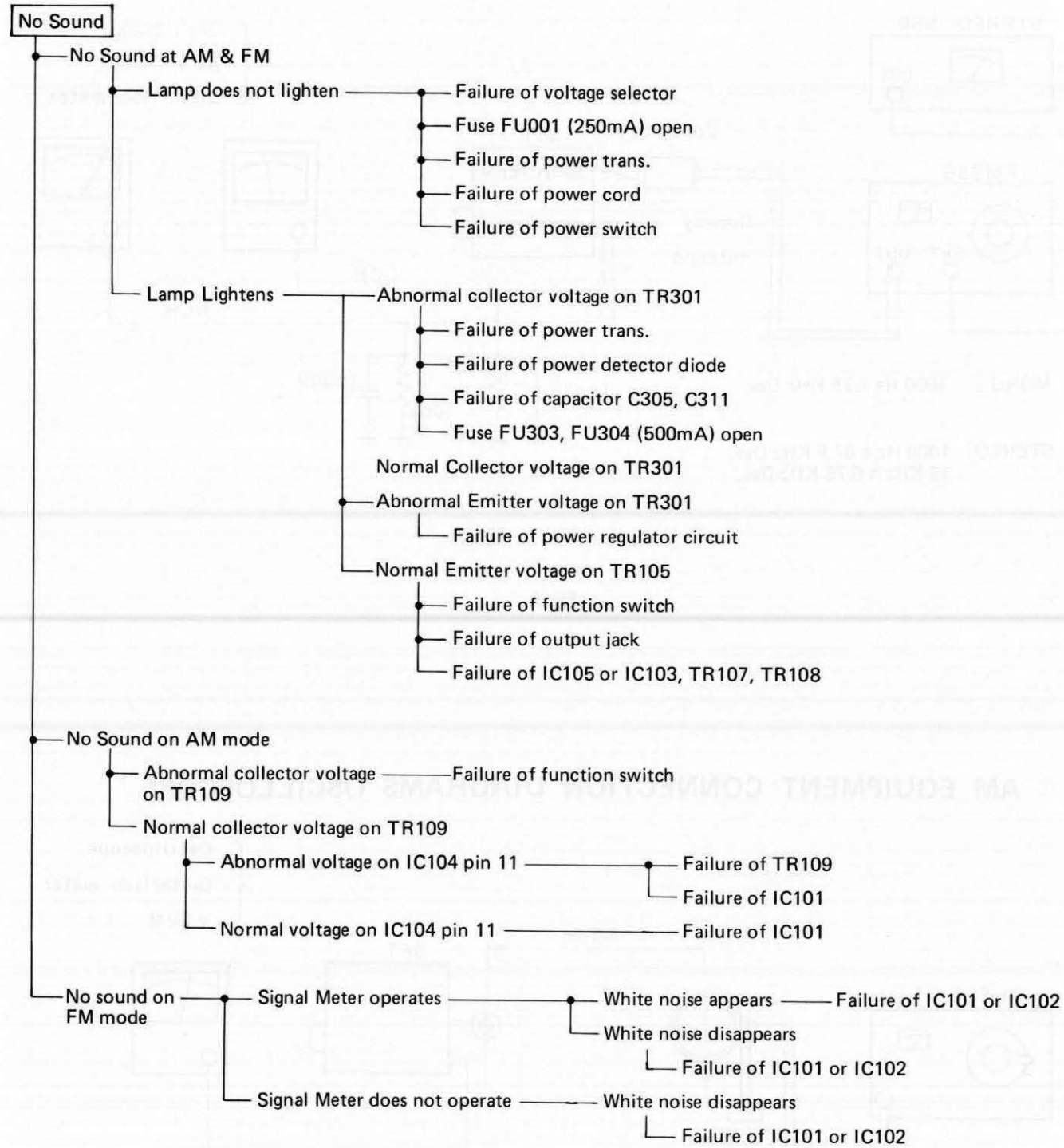

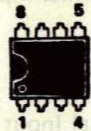

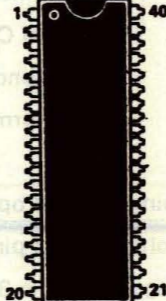

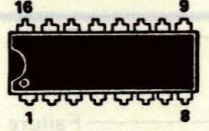
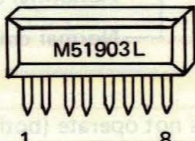

Fig. 9

# TROUBLESHOOTING



# TRANSISTOR & IC LEAD IDENTIFICATION

2SA915 	TR304	$\mu$ PC-78MO <sup>S</sup> $\mu$ PC-1430 <sup>S</sup> 1 Input 2 Output 3 GND 	IC301	LM-1458N 	IC201
2SD526 	TR301	$\mu$ PC-1163H 	IC101	MSM-5525 	IC451
2SC945 2SC900 2SA733 2SC1222E 	TR102 TR103 TR105 TR106 TR107 TR108 TR109 TR110 TR204 TR206 TR207 TR208 TR209 TR210 TR211 TR212 TR213 TR302 TR451 TR452	HA11225 HA1197 HA11223W KB4438 	IC102 IC103 IC104 IC105	M51903L 	IC202

## IF PWB ASS'Y (Component Side)

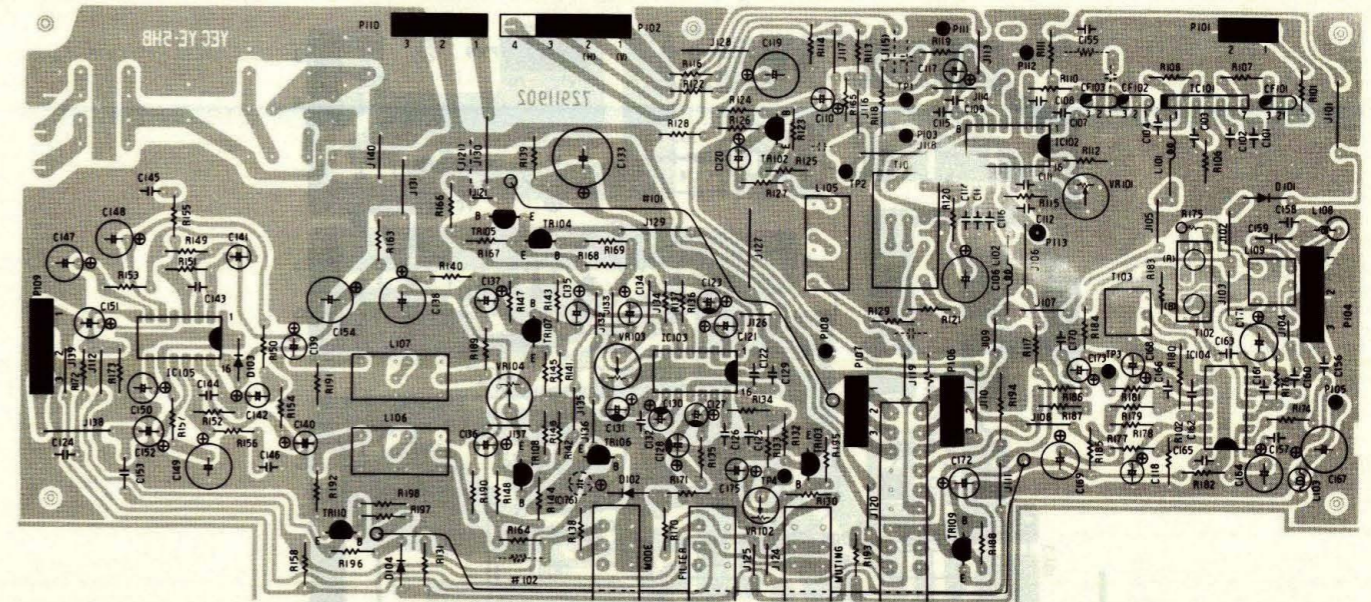

## IF PWB ASS'Y (Solder Side)

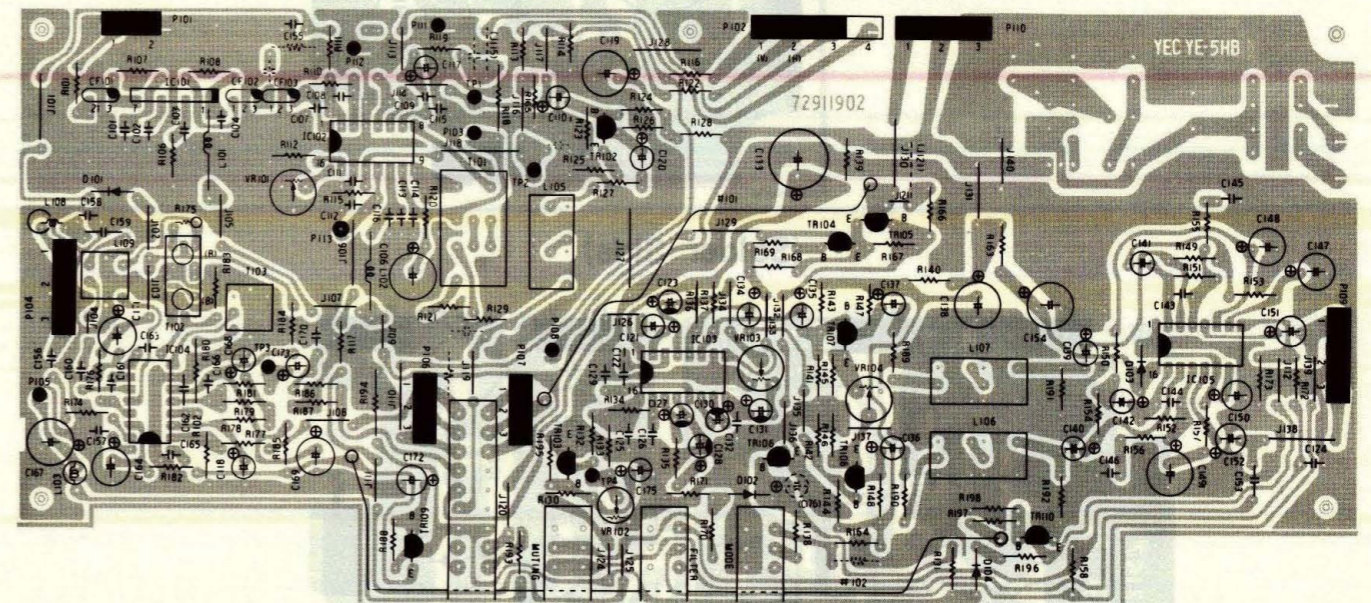

## VOLUME PWB ASS'Y (Component Side)

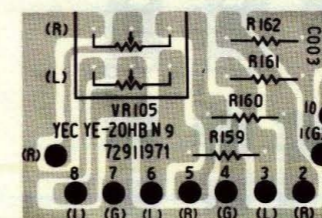

## (Solder Side)

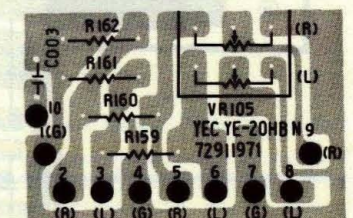

**POWER SUPPLY PWB ASS'Y**  
(Component Side)

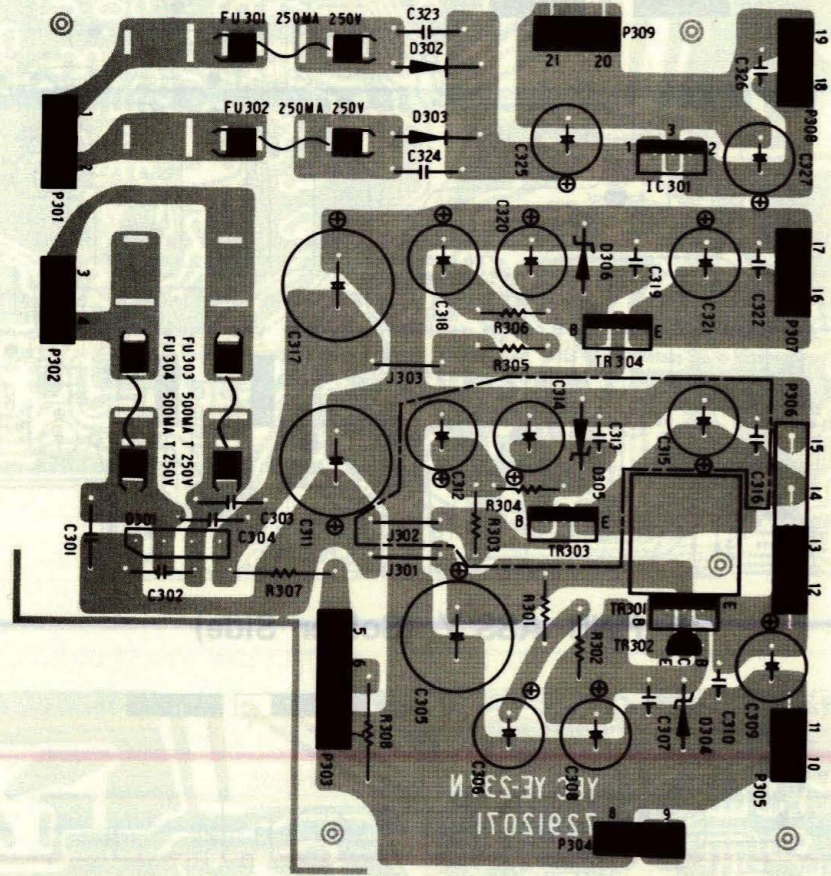

(Solder Side)

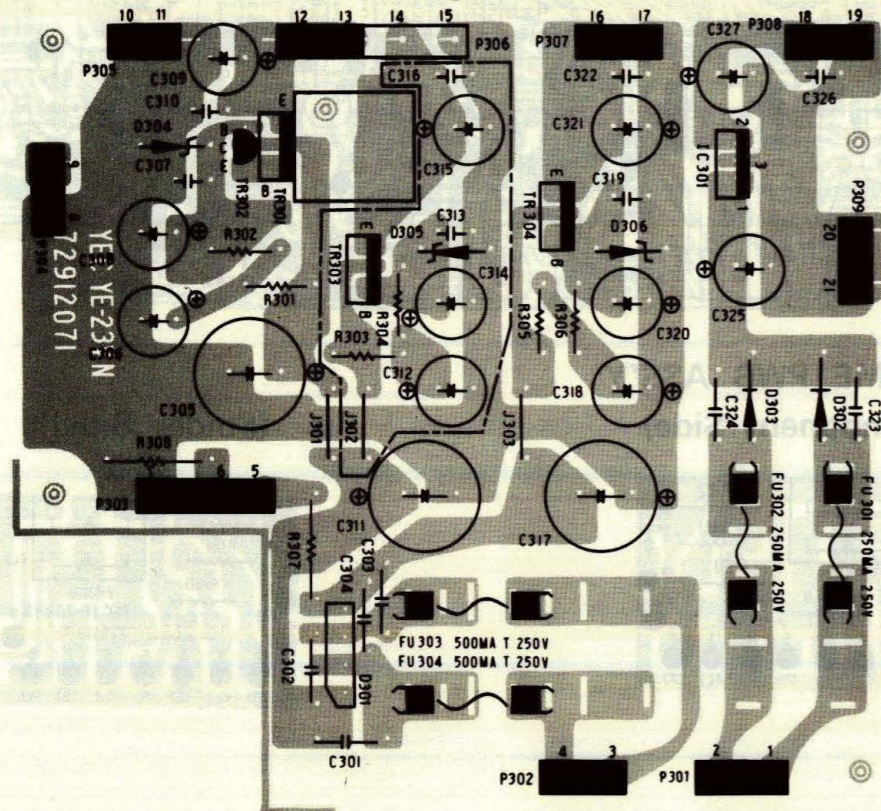

**FM LEAD OUT PWB ASS'Y**  
(Component Side)

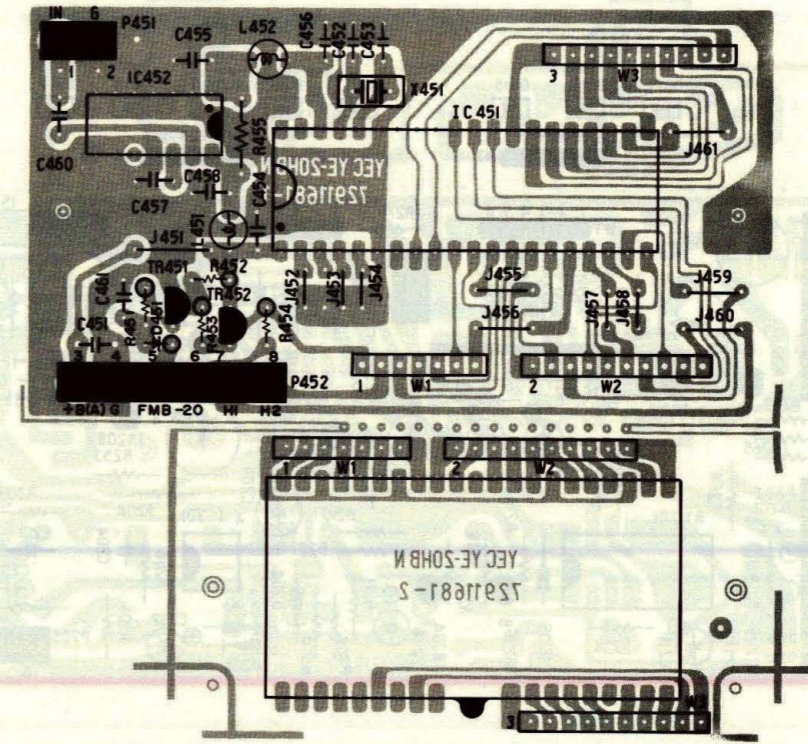

(Solder Side)

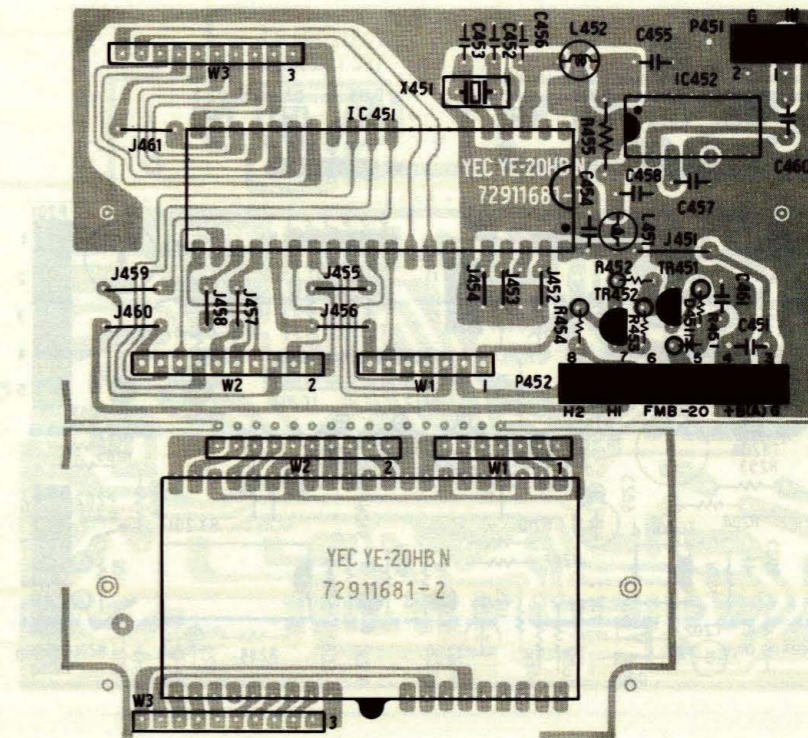

**SERVO LOCKED PWB ASS'Y**

(Component Side)

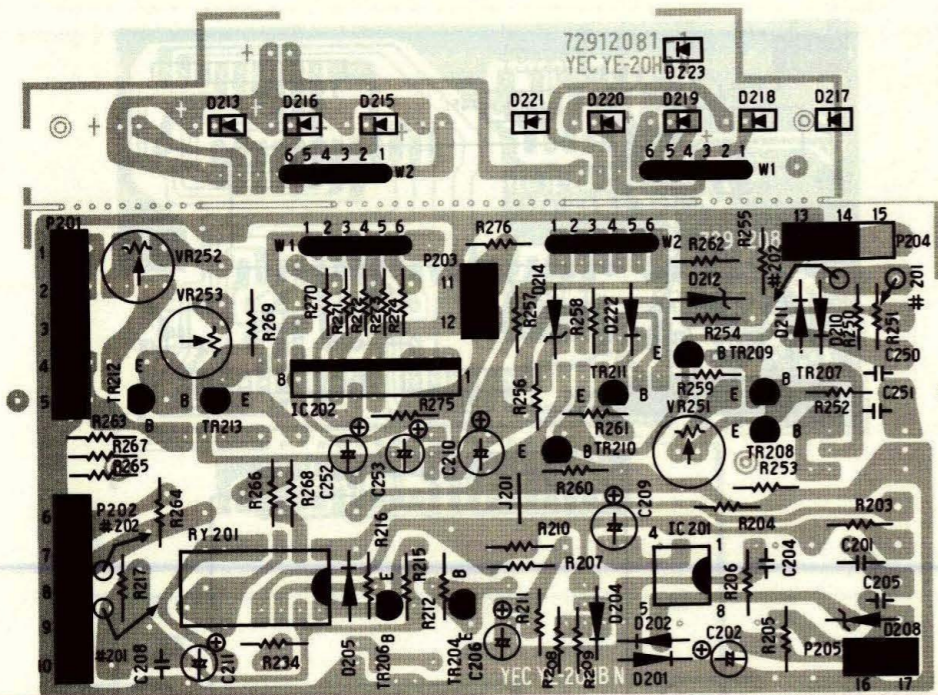

(Solder Side)

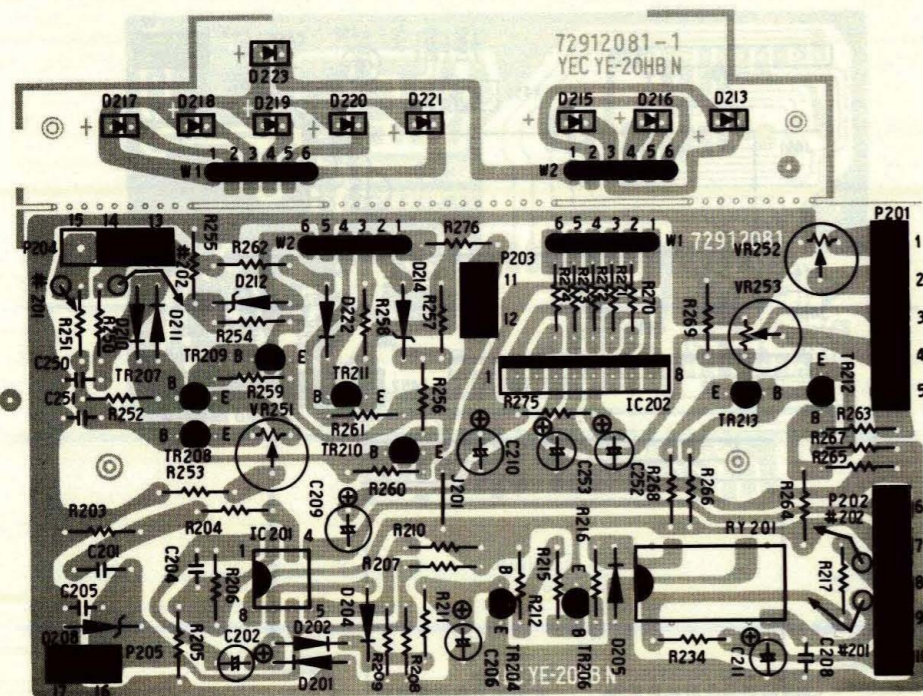

**WIRING DIAGRAM**

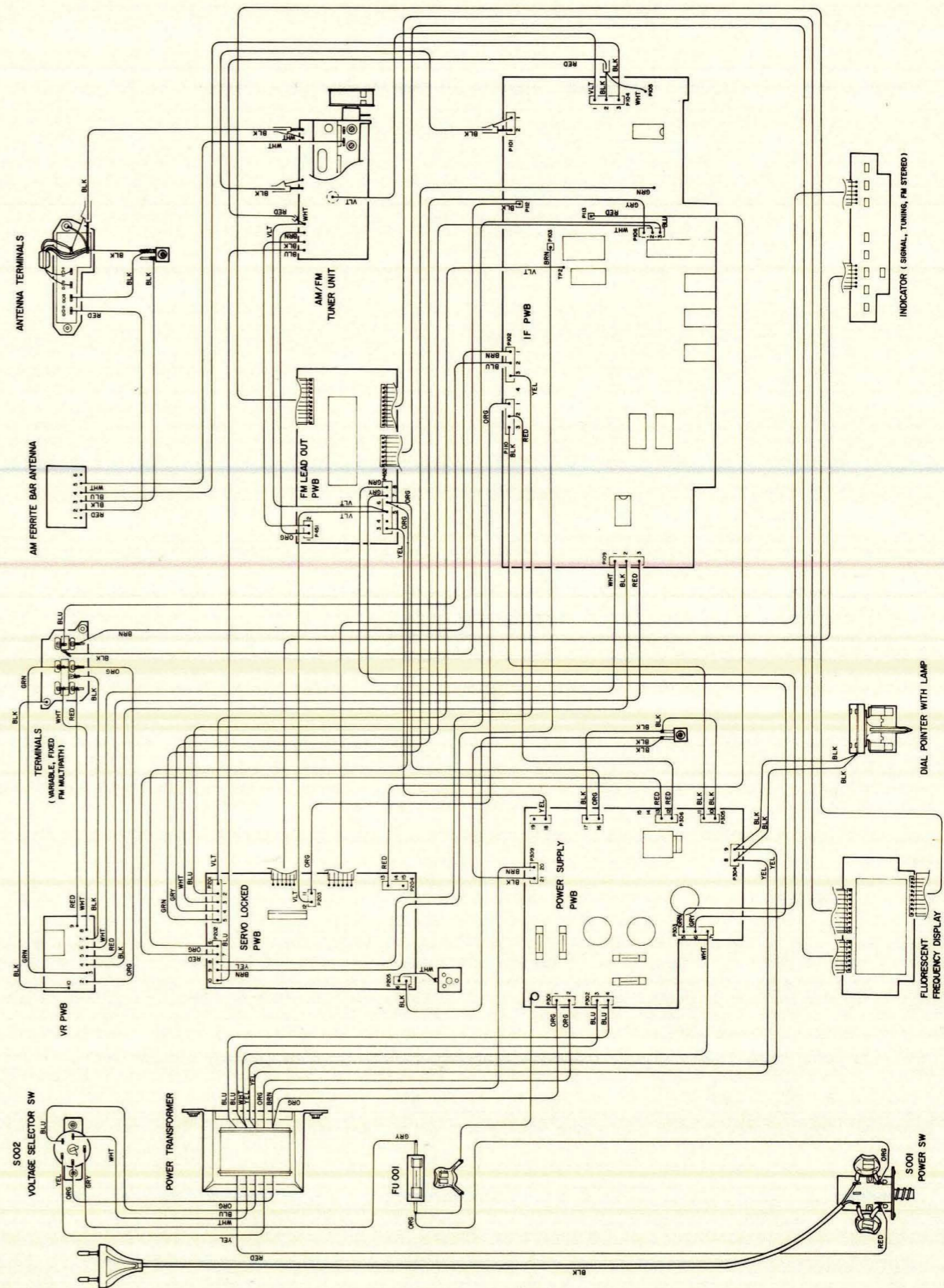



# Schematic Diagram

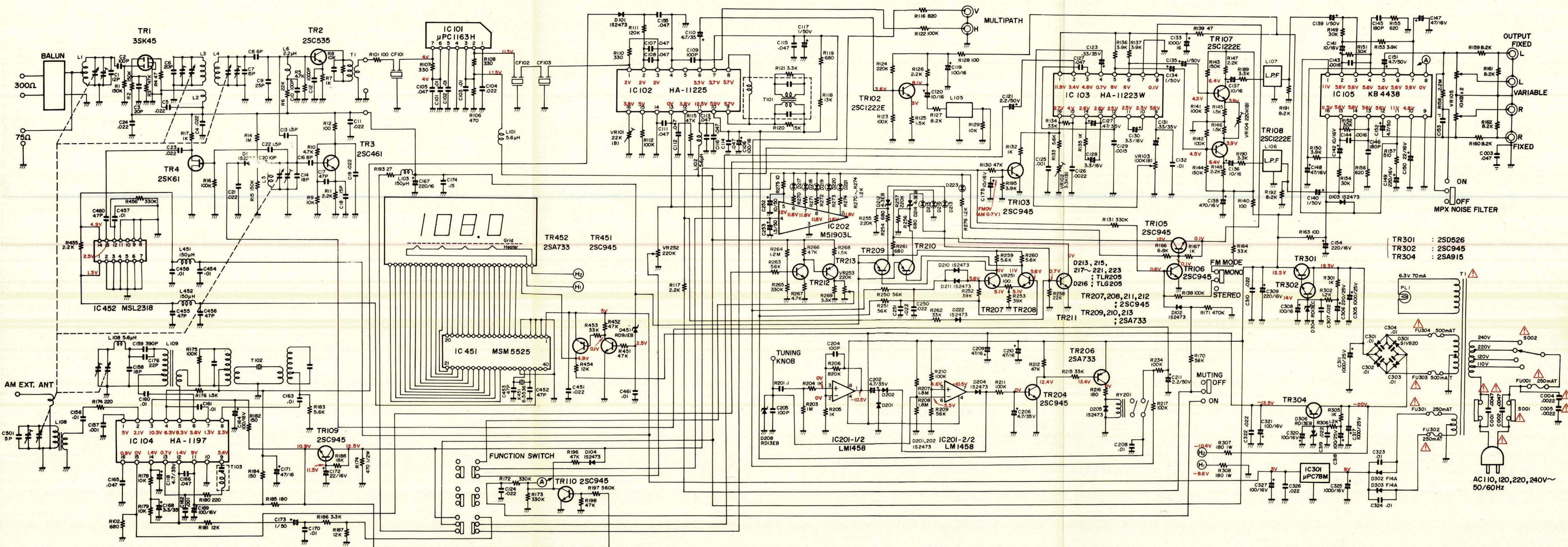

- TR301 : 2SD526
- TR302 : 2SC945
- TR304 : 2SA915

AC 110, 120, 220, 240V~  
50/60Hz

# REPLACEMENT PARTS LIST

FOR

# NEC

## STEREO TUNER



SYMBOL NO.	PARTS NO.	DESCRIPTION	Q'TY	REMARKS
------------	-----------	-------------	------	---------

### Transistors

TR206, 209, 210, 213, 452	35003516	Transistor 2SA733/733A P	5	
TR204, 207, 208, 311, 212	35047216	Transistor 2SC-945 P	5	
TR103, 105, 106, 109, 110, 302, *451	35047217	Transistor 2SC945 Q	6	
TR451	35047218	Transistor 2SC945 R	1	
TR304	35900212	Transistor 2SA915 L	1	
TR102, 107, 108	35943605	Transistor 2SC-1222E	3	
TR301	35960415	Transistor 2SD526 (O)	1	

### Diodes

D101, 102, 103, 104, 201, 202, 204, 205, 210, 211, 222	36001009	Diode, Si. 1S-2473	11	
D451	36003037	Diode, Zener RD9.1EB	1	
D208, 306	36003042	Diode, Zener RD13E-B	2	
D212, 214	36003080	Diode, RD-4.3E (B)	2	
D302, 303	36107065	Rectifier, Si. F14A	2	
D301	36902050	REC Tifier	1	
D213, 215, 217, 218, 219, 220, 221, 223	36904037	LED TLR205	8	
D216	36904042	LED TLG205	1	
D304	36905012	Diode, RD13EC	1	

### ICs

IC201	37901034	IC LM1458N	1	
IC202	37901038	IC M51903 L	1	
IC101	37902020	IC UPC1163H	1	
IC102	37902021	IC HA-11225	1	
IC103	37902022	IC HA-11223W	1	
IC104	37902023	IC HA-1197	1	

SYMBOL NO.	PARTS NO.	DESCRIPTION	Q'TY	REMARKS
IC105	37902024	IC KB-4438	1	
IC451	37903041	IC MSM5525	1	
IC452	37903042	IC MSL2318	1	
IC301	37903043	IC UPC78M05	1	

### Resistors

R194	40003033	R, Solid	470Ω	10%	¼W	1	
R180	40102157	R, Carbon	220Ω	5%	¼W	1	
R454	40112199	R, Carbon	12KΩ	5%	¼W	1	
R453	40112209	R, Carbon	33KΩ	5%	¼W	1	
R451, 452	40112213	R, Carbon	47KΩ	5%	¼W	2	
R455	40112233	R, Carbon	330KΩ	5%	¼W	1	
R307, 308	40351155	R, Metal	180Ω	5%	1W	2	
R118	40910043	R, Carbon	13KΩ	5%	¼W	1	
R275	40982125	R, Carbon	10Ω	5%	¼W	1	
R193	40982135	R, Carbon	27Ω	5%	¼W	1	
R139	40982141	R, Carbon	47Ω	5%	¼W	1	
R101, 128, 140	40982149	R, Carbon	100Ω	5%	¼W	4	
R182, 184	40982153	R, Carbon	150Ω	5%	¼W	2	
R185, 216	40982155	R, Carbon	180Ω	5%	¼W	2	
R174	40982157	R, Carbon	220Ω	5%	¼W	1	
R107, 108, 110	40982161	R, Carbon	330Ω	5%	¼W	3	
R106	40982165	R, Carbon	470Ω	5%	¼W	1	
R157	40982166	R, Carbon	510Ω	5%	¼W	1	
R155, 156	40982168	R, Carbon	620Ω	5%	¼W	2	
R102, 119, 254, 256, 261	40982169	R, Carbon	680Ω	5%	¼W	5	
R116	40982171	R, Carbon	820Ω	5%	¼W	1	
R132, 135, 167, 204, 205, 301, 305	40982173	R, Carbon	1.0KΩ	5%	¼W	7	
R270, 271, 272, 273, 274, 276, 302, 306	40982175	R, Carbon	1.2KΩ	5%	¼W	8	
R125, 145, 146, 176, 268	40982177	R, Carbon	1.5KΩ	5%	¼W	5	
R117, 126, 147, 148, 455	40982181	R, Carbon	2.2KΩ	5%	¼W	5	
R121, 186, 189, 190, 269	40982185	R, Carbon	3.3KΩ	5%	¼W	5	
R136, 137, 150, 153, 195	40982187	R, Carbon	3.9KΩ	5%	¼W	5	
R267	40982189	R, Carbon	4.7KΩ	5%	¼W	1	
R133, 183, 259, 260	40982191	R, Carbon	5.6KΩ	5%	¼W	4	
R166	40982193	R, Carbon	6.8KΩ	5%	¼W	1	
R127, 159, 160, 161, 162, 191, 192	40982195	R, Carbon	8.2KΩ	5%	¼W	7	
R129, 178, 179	40982197	R, Carbon	10KΩ	5%	¼W	3	
R181, 187	40982199	R, Carbon	12KΩ	5%	¼W	2	

SYMBOL NO.	PARTS NO.	DESCRIPTION	Q'TY	REMARKS		
R120	40982201	R, Carbon 15KΩ	5%	¼W	1	
R188	40982203	R, Carbon 18KΩ	5%	¼W	1	
R258	40982205	R, Carbon 22KΩ	5%	¼W	1	
R149, 151, 152, 154	40982208	R, Carbon 30KΩ	5%	¼W	4	
R134, 164, 215, 262	40982209	R, Carbon 33KΩ	5%	¼W	4	
R252, 253	40982211	R, Carbon 39KΩ	5%	¼W	2	
R115, 130, 196, 198, 212, 266	40982213	R, Carbon 47KΩ	5%	¼W	6	
R170, 209, 250, 251, 263	40982215	R, Carbon 56KΩ	5%	¼W	5	
R112, 122, 123, 138, 141, 142, 210, 211, 217, 234	40982221	R, Carbon 100KΩ	5%	¼W	10	
R111	40982223	R, Carbon 120KΩ	5%	¼W	1	
R143, 144	40982225	R, Carbon 150KΩ	5%	¼W	2	
R124, 172, 255, 257	40982229	R, Carbon 220KΩ	5%	¼W	4	
R131, 173, 265	40982233	R, Carbon 330KΩ	5%	¼W	3	
R171	40982237	R, Carbon 470KΩ	5%	¼W	1	
R197	40982239	R, Carbon 560KΩ	5%	¼W	1	
R206	40982243	R, Carbon 820KΩ	5%	¼W	1	
R203	40982245	R, Carbon 1.0MΩ	5%	¼W	1	
R264	40982247	R, Carbon 1.2MΩ	5%	¼W	1	
R207, 208	40982251	R, Carbon 1.8MΩ	5%	¼W	2	
R158	40982253	R, Carbon 2.2MΩ	5%	¼W	1	
R175	40983221	R, Carbon 100KΩ	5%	¼W	1	
VR103	41061006	R, Variable 100KΩ	0.15W		1	
VR104, 252, 253	41061010	R, Variable 220KΩ	0.15W		3	
VR101	41061012	R, Variable 22KΩ	0.15W		1	
VR251	41950191	R, Variable 100ΩB			1	
VR102	41950233	R, Variable			1	
VR105	41950298	R, Variable 10KΩ	B		1	

### Capacitors

C301, 302, 303, 304, 323, 324	42019575	C, Ceramic 500V	0.01μF		6	
C208, 454, 457, 458, 461	42110425	C, Ceramic 50V	0.01μF		5	
C124, 250, 251, 307, 310, 319, 322, 326, 451	42110429	C, Ceramic 50V	0.022μF		9	
C003, 107, 108, 111, 112, 113, 114, 115, 116, 165, 166	42110433	C, Ceramic 50V	0.047μF		11	
C157, 162	42110913	C, Ceramic 50V	1000pF		2	
C101, 102, 103, 156, 160, 161, 163, 170	42110925	C, Ceramic 50V	0.01μF		8	
C104	42110929	C, Ceramic 50V	0.022μF		1	
C105, 155	42110933	C, Ceramic 50V	0.047μF		2	
C109, 204, 205	42331045	C, Ceramic 50V	100pF		3	

SYMBOL NO.	PARTS NO.	DESCRIPTION	Q'TY	REMARKS
C145, 146	42331072	C, Ceramic 50V 180pF 10%	2	
C176	42332029	C, Ceramic 50V 22pF	1	
C452, 453, 455, 460	42332037	C, Ceramic 50V 47pF	5	
C158	42335060	C, Ceramic 50V 280pF 10%	1	
C159	42407163	C, Mica 50V 390pF	1	
C001, 002	42606007	C, Metalized Paper	2	
C129	42754053	C, Mylar 50V 1500pF	1	
C132	42754063	C, Mylar 50V 0.01μF	1	
C122	42754071	C, Mylar 50V 0.047μF	1	
C153, 201	42754075	C, Mylar 50V 0.1μF	2	
C174	42754076	C, Mylar 50V 0.15μF	1	
C126	42970022	C, Poly 50V 2200pF 5%	1	
C143, 144	42970040	C, Poly 50V 1600pF	2	
C125	42972025	C, Poly 125V 1000pF 5%	1	
C128, 130	43515052	C, Tantalum 16V 3.3μF	2	
C123, 131	43515068	C, Tantalum 35V 0.33μF	2	
C127	43515069	C, Tantalum 35V 0.47μF	1	
C173	43980047	C, Elec. 50V 0.1μF	1	
C120, 136, 137, 141, 142, 175, 252	43991028	C, Elec. 16V 10VF B	7	
C150, 172	43991029	C, Elec.	2	
C147, 148, 171, 209, 210	43991031	C, Elec.	5	
C106, 119, 308, 320, 321, 327	43991032	C, Elec. 16V 100μF	6	
C149, 154, 309	43991033	C, Elec. 16V 220μF	3	
C318	43991047	C, Elec. 25V 100μF	1	
C311, 317	43991051	C, Elec. 25V 1000μF	2	
C168	43991054	C, Elec. 35V 3.3μF	1	
C110, 118, 202, 206	43991055	C, Elec. 35V 4.7μF B	4	
C117, 134, 135, 139, 140	43991066	C, Elec.	5	
C121, 211, 253	43991067	C, Elec.	3	
C151, 152	43991069	C, Elec. 50V 4.7μF	2	
C164, 169	43993028	C, Elec. 16V 100μF	2	
C167	43993029	C, Elec. 16V 220μF	1	
C138	43993031	C, Elec. 16V 470μF	1	
C133, 325	43993032	C, Elec. 16V 1000μF	2	
C306	43993042	C, Elec. 25V 220μF	1	
C305	43993045	C, Elec. 25V 1000μF	1	

**Transformer and Coils**

	45027083	Trans, Power	1	
L101, 102, 108	61021002	Choke Coil	3	

**EXPLODED VIEW OF SET**

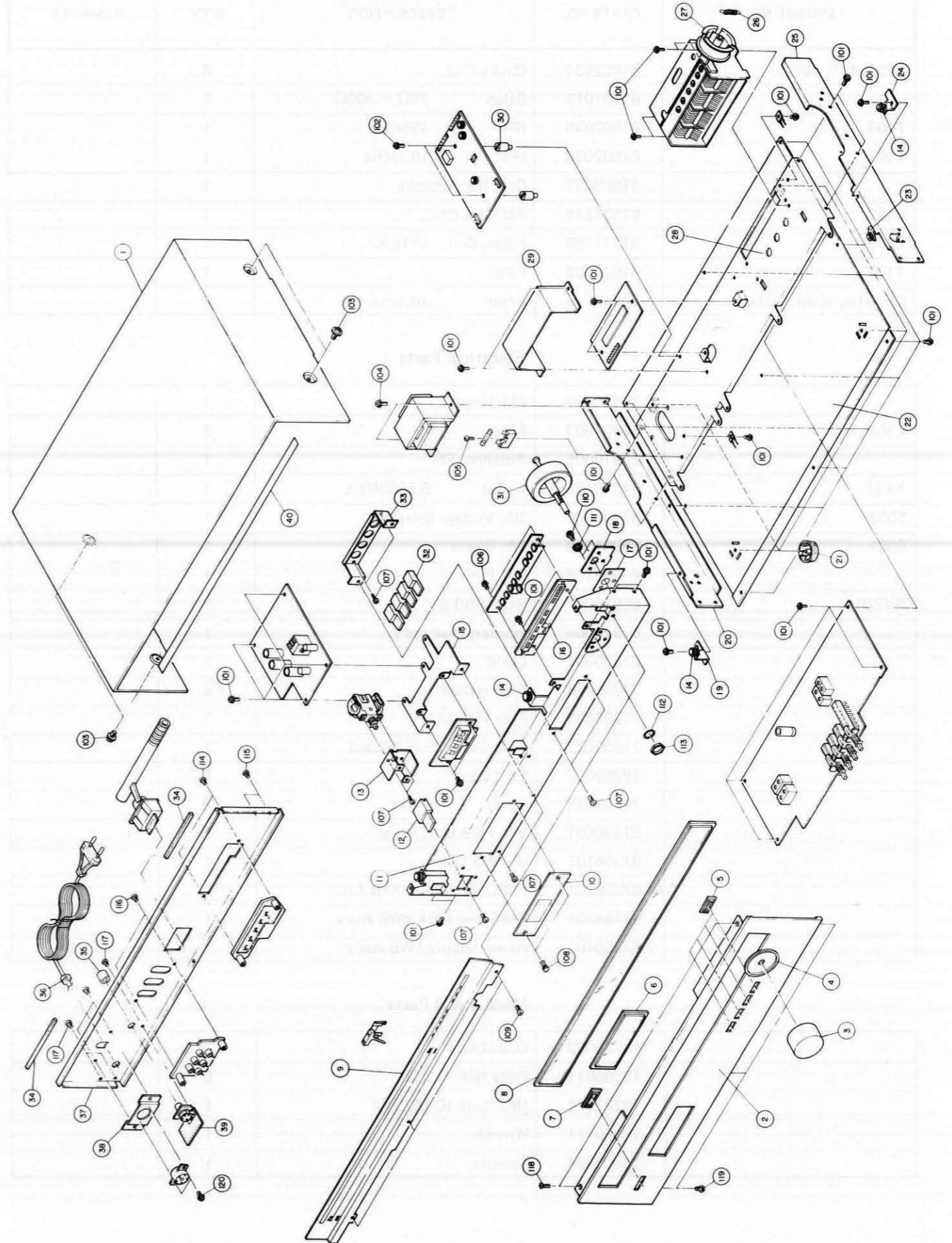

SYMBOL NO.	PARTS NO.	DESCRIPTION	Q'TY	REMARKS
L103, 451, 452	61052031	Choke Coil	3	
	61601011	Balan 75Ω ~ 300Ω	1	
T103	61902035	IFT 455KHz	1	
T101	61902036	IFT 10.7MHz	1	
	61903027	Coil, Bar Antenna	1	
L109	61904378	AM OSC Coil	1	
L105	61911088	Filter, Coil 114KHz	1	
T102	61919006	Filter	1	
CF101A, 102A, 103A	61919016	Filter 10.7mm (A)	3	

#### Electrical Parts

	34401109	FM Tuner	1	
L106, 107	39907003	Filter	2	
	62910005	Antenna, FM	1	
X451	64920125	X, Tal 6.5536MHz	1	
S002	65901039	SW, Voltage Selecter	1	
S001	65904049	SW, Power	1	
	65904107	SW, Push	1	
RY201	65910047	Reay PRB-2	1	
	67920005	Pointer, Dial Ass'y	1	
	67930001	Lamp	1	
	71205023	Fuse Holder	8	
	71205031	Fuse Holder 1P	1	
	71905027	Antenna-Terminal Board	1	
	79759052	Line Cord	1	
	79799118	Cover	2	
	87339501	VR, PWB Unit Ass'y	1	
	87355101	IF PWB Unit	1	
	87355201	FM Lead output PWB Ass'y	1	
	87355301	FM Servo Lock PWB Ass'y	1	
	87355401	Power Supply PWB Ass'y	1	

#### Mechanical Parts

	18286002	Dial Drum	1	
	18286011	Pully NIF	5	
	18287821	Heat Sink IC-1625-ST	1	
	18289171	Wrench	1	
	18509931	Spindle	1	

SYMBOL NO.	PARTS NO.	DESCRIPTION	Q'TY	REMARKS
------------	-----------	-------------	------	---------

#### Knobs

	18457041	VR Knob, Controls	1	
	18457201	Knob	1	
	18457311	Push, Knob	4	
	18457321	Knob, Tuning	1	
	18710461	Dial, Scale	1	
	18710471	Dial, Filter	1	
	18710491	Filter A	1	
	18710501	Filter B	1	
	18710511	Knob Clip	1	
	88355131	Panel, Rear S Ass'y	1	
	88355631	Panel, Front S Ass'y	1	

#### Cabinet

	18286241	Foot UL	4	
	18513571	Cover, Bottom	1	
	18513981	Panel, Rear	1	
	19525881	Cabinet	1	

#### Accessories

	78911531	Instruction Book	1	
--	----------	------------------	---	--

#### Packing Materials

	18603251	Filler, Carton	1	
	18753101	Label	1	
	18801031	Bag, Polyethylene (1/12)	1	
	18805031	Display Box	1	
	18805371	Filler, Carton	2	
	19800672	Bag-B, Polyethylene	1	
	19804261	Bag, Protection	1	

Material	Qty	Category	Part No	Part Name
----------	-----	----------	---------	-----------

Knobs

	1	Knob, Round	1845201	Knob, Round
	1	Knob, Round	1845202	Knob, Round
	1	Knob, Round	1845203	Knob, Round
	1	Knob, Round	1845204	Knob, Round
	1	Knob, Round	1845205	Knob, Round
	1	Knob, Round	1845206	Knob, Round
	1	Knob, Round	1845207	Knob, Round
	1	Knob, Round	1845208	Knob, Round
	1	Knob, Round	1845209	Knob, Round
	1	Knob, Round	1845210	Knob, Round
	1	Knob, Round	1845211	Knob, Round
	1	Knob, Round	1845212	Knob, Round
	1	Knob, Round	1845213	Knob, Round
	1	Knob, Round	1845214	Knob, Round

Buttons

	1	Button, Round	1845215	Button, Round
	1	Button, Round	1845216	Button, Round
	1	Button, Round	1845217	Button, Round
	1	Button, Round	1845218	Button, Round

Fasteners

	1	Fastener, Bolt	1845219	Fastener, Bolt
	1	Fastener, Bolt	1845220	Fastener, Bolt
	1	Fastener, Bolt	1845221	Fastener, Bolt
	1	Fastener, Bolt	1845222	Fastener, Bolt
	1	Fastener, Bolt	1845223	Fastener, Bolt
	1	Fastener, Bolt	1845224	Fastener, Bolt
	1	Fastener, Bolt	1845225	Fastener, Bolt
	1	Fastener, Bolt	1845226	Fastener, Bolt
	1	Fastener, Bolt	1845227	Fastener, Bolt
	1	Fastener, Bolt	1845228	Fastener, Bolt
	1	Fastener, Bolt	1845229	Fastener, Bolt
	1	Fastener, Bolt	1845230	Fastener, Bolt
	1	Fastener, Bolt	1845231	Fastener, Bolt
	1	Fastener, Bolt	1845232	Fastener, Bolt
	1	Fastener, Bolt	1845233	Fastener, Bolt
	1	Fastener, Bolt	1845234	Fastener, Bolt
	1	Fastener, Bolt	1845235	Fastener, Bolt
	1	Fastener, Bolt	1845236	Fastener, Bolt
	1	Fastener, Bolt	1845237	Fastener, Bolt
	1	Fastener, Bolt	1845238	Fastener, Bolt
	1	Fastener, Bolt	1845239	Fastener, Bolt
	1	Fastener, Bolt	1845240	Fastener, Bolt