

# Pioneer

## Service Manual

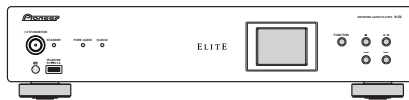

N-50

ORDER NO.  
**RRV4272**

**NETWORK AUDIO PLAYER**

# N-50

# N-50-K

# N-50-S

# N-30

# N-30-K

# N-30-S

**THIS MANUAL IS APPLICABLE TO THE FOLLOWING MODEL(S) AND TYPE(S).**

Model	Type	Power Requirement	Remarks
N-50	CUXE	AC 120V	
N-50-K	SYXE8	AC 220V to 240V	
N-50-S	SYXE8	AC 220V to 240V	
N-30	CUXE	AC 120V	
N-30-K	SYXE8	AC 220V to 240V	
N-30-S	SYXE8	AC 220V to 240V	



**PIONEER CORPORATION** 1-1, Shin-ogura, Saiwai-ku, Kawasaki-shi, Kanagawa 212-0031, Japan

**PIONEER ELECTRONICS (USA) INC.** P.O. Box 1760, Long Beach, CA 90801-1760, U.S.A.

**PIONEER EUROPE NV** Haven 1087, Keetberglaan 1, 9120 Melsele, Belgium

**PIONEER ELECTRONICS ASIACENTRE PTE. LTD.** 253 Alexandra Road, #04-01, Singapore 159936

©PIONEER CORPORATION 2012

# SAFETY INFORMATION



This service manual is intended for qualified service technicians ; it is not meant for the casual do-it-yourselfer. Qualified technicians have the necessary test equipment and tools, and have been trained to properly and safely repair complex products such as those covered by this manual. Improperly performed repairs can adversely affect the safety and reliability of the product and may void the warranty. If you are not qualified to perform the repair of this product properly and safely, you should not risk trying to do so and refer the repair to a qualified service technician.

## WARNING

This product contains lead in solder and certain electrical parts contain chemicals which are known to the state of California to cause cancer, birth defects or other reproductive harm.

Health & Safety Code Section 25249.6 - Proposition 65

## NOTICE

(FOR CANADIAN MODEL ONLY)

Fuse symbols (fast operating fuse) and/or (slow operating fuse) on PCB indicate that replacement parts must be of identical designation.

## REMARQUE

(POUR MODÈLE CANADIEN SEULEMENT)

Les symboles de fusible (fusible de type rapide) et/ou (fusible de type lent) sur CCI indiquent que les pièces de remplacement doivent avoir la même désignation.

(FOR USA MODEL ONLY)

## 1. SAFETY PRECAUTIONS

The following check should be performed for the continued protection of the customer and service technician.

### LEAKAGE CURRENT CHECK

Measure leakage current to a known earth ground (water pipe, conduit, etc.) by connecting a leakage current tester such as Simpson Model 229-2 or equivalent between the earth ground and all exposed metal parts of the appliance (input/output terminals, screwheads, metal overlays, control shaft, etc.). Plug the AC line cord of the appliance directly into a 120V AC 60 Hz outlet and turn the AC power switch on. Any current measured must not exceed 0.5 mA.

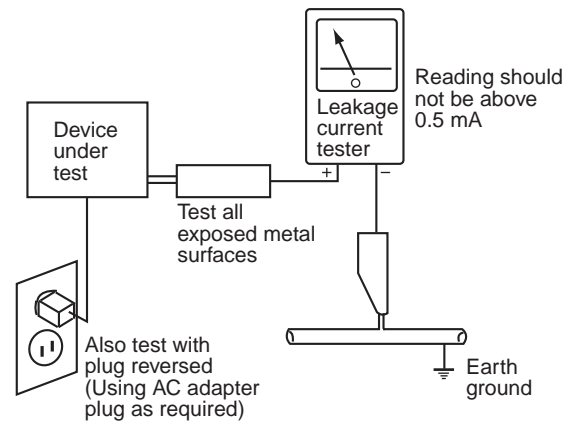

AC Leakage Test

ANY MEASUREMENTS NOT WITHIN THE LIMITS OUTLINED ABOVE ARE INDICATIVE OF A POTENTIAL SHOCK HAZARD AND MUST BE CORRECTED BEFORE RETURNING THE APPLIANCE TO THE CUSTOMER.

## 2. PRODUCT SAFETY NOTICE

Many electrical and mechanical parts in the appliance have special safety related characteristics. These are often not evident from visual inspection nor the protection afforded by them necessarily can be obtained by using replacement components rated for voltage, wattage, etc. Replacement parts which have these special safety characteristics are identified in this Service Manual.

Electrical components having such features are identified by marking with a on the schematics and on the parts list in this Service Manual.

The use of a substitute replacement component which does not have the same safety characteristics as the PIONEER recommended replacement one, shown in the parts list in this Service Manual, may create shock, fire, or other hazards.

Product Safety is continuously under review and new instructions are issued from time to time. For the latest information, always consult the current PIONEER Service Manual. A subscription to, or additional copies of, PIONEER Service Manual may be obtained at a nominal charge from PIONEER.

# CONTENTS

SAFETY INFORMATION.....	2	
1. SERVICE PRECAUTIONS.....	4	
1.1 NOTES ON SOLDERING.....	4	A
2. SPECIFICATIONS.....	5	
2.1 ACCESSORIES.....	5	
2.2 SPECIFICATIONS.....	5	
2.3 PLAYABLE FILE FORMATS.....	6	
3. BASIC ITEMS FOR SERVICE.....	10	
3.1 CHECK POINTS AFTER SERVICING.....	10	
3.2 PCB LOCATIONS.....	11	
3.3 JIGS LIST.....	12	
4. BLOCK DIAGRAM.....	14	
4.1 OVERALL CONNECTION DIAGRAM (1/2).....	14	
4.2 OVERALL CONNECTION DIAGRAM (2/2).....	16	
4.3 BLOCK DIAGRAM.....	18	B
5. DIAGNOSIS.....	20	
5.1 TROUBLESHOOTING.....	20	
5.2 PROTECTION CIRCUIT ERROR DETECTION.....	23	
5.3 HOW TO CHECK THE IC COMMUNICATION.....	24	
5.4 IC INFORMATION.....	24	
6. SERVICE MODE.....	25	
6.1 SERVICE MODE.....	25	
6.2 INITIAL SETTING.....	27	
7. DISASSEMBLY.....	28	
8. EACH SETTING AND ADJUSTMENT.....	34	
8.1 FIRMWARE UPDATE.....	34	
8.2 HOW TO CHECK EACH TERMINAL.....	37	C
9. EXPLODED VIEWS AND PARTS LIST.....	40	
9.1 PACKING SECTION.....	40	
9.2 EXTERIOR SECTION.....	42	
10. SCHEMATIC DIAGRAM.....	44	
10.1 JACK ASSY.....	44	
10.2 D-MAIN ASSY (1/5).....	46	
10.3 D-MAIN ASSY (2/5).....	48	
10.4 D-MAIN ASSY (3/5).....	50	
10.5 D-MAIN ASSY (4/5).....	52	
10.6 D-MAIN ASSY (5/5).....	54	
10.7 DAC ASSY.....	56	
10.8 LCD/KEY ASSY.....	58	D
10.9 LED ASSY, POWER SW ASSY, IR ASSY AND POWER LED ASSY.....	60	
10.10 USB ASSY.....	62	
10.11 STBY ASSY.....	64	
10.12 CNT A ASSY AND CNT B ASSY.....	66	
10.13 GUIDE 1, GUIDE 2(N-50, N-50-K/-S ONLY), GUIDE 3 AND GUIDE 4 ASSYS.....	68	
11. PCB CONNECTION DIAGRAM.....	70	
11.1 JACK ASSY.....	70	
11.2 D-MAIN ASSY.....	72	
11.3 DAC ASSY.....	76	
11.4 LCD/KEY ASSY.....	80	
11.5 LED ASSY, POWER SW ASSY, IR ASSY AND POWER LED ASSY.....	82	E
11.6 USB ASSY AND STBY ASSY.....	84	
11.7 CNT A ASSY AND CNT B ASSY.....	88	
11.8 GUIDE 1, GUIDE 2 (N-50, N-50-K/-S ONLY), GUIDE 3 AND GUIDE 4 ASSYS.....	90	
12. PCB PARTS LIST.....	92	

# 1. SERVICE PRECAUTIONS

## 1.1 NOTES ON SOLDERING

A

- For environmental protection, lead-free solder is used on the printed circuit boards mounted in this unit.  
Be sure to use lead-free solder and a soldering iron that can meet specifications for use with lead-free solders for repairs accompanied by reworking of soldering.
- Compared with conventional eutectic solders, lead-free solders have higher melting points, by approximately 40 °C. Therefore, for lead-free soldering, the tip temperature of a soldering iron must be set to around 373 °C in general, although the temperature depends on the heat capacity of the PC board on which reworking is required and the weight of the tip of the soldering iron.

Do NOT use a soldering iron whose tip temperature cannot be controlled.

B

Compared with eutectic solders, lead-free solders have higher bond strengths but slower wetting times and higher melting temperatures (hard to melt/easy to harden).

The following lead-free solders are available as service parts:

- Parts numbers of lead-free solder:  
GYP1006 1.0 in dia.  
GYP1007 0.6 in dia.  
GYP1008 0.3 in dia.

C

D

E

F

## 2. SPECIFICATIONS

### 2.1 ACCESSORIES

- Remote control unit (8300764100010-IL)
- AC Power cord (N-50, N-30 :L068125130010-IL)  
(N-50-K/-S, N-30-K/-S :L068250160020-IL)
- Operating instructions (N-50, N-30 :5707000006130-IL)  
(N-50-K/-S, N-30-K/-S :5707000006140-IL)  
(N-50-K/-S, N-30-K/-S :6517000000450-IL)
- Audio cable (L063102020050-IL)
- Warranty card (N-50-K/-S, N-30-K/-S :ARY7128)
- Safety sheet (N-50-K/-S, N-30-K/-S :5227000002330-IL)
- Caution sheet (N-50, N-30 :5227000002270-IL)  
(N-50-K/-S, N-30-K/-S :5227000002280-IL)
- AAA/R03 dry cell battery x 2

### 2.2 SPECIFICATIONS

#### •Generalites

System. . . . . Network Audio Player  
 Power requirements. . . . . AC 120 V, 60 Hz  
 (N-50, N-30)  
 Power requirements. . . . . AC 220 V to AC240V, 50/60 Hz  
 (N-50-K/-S, N-30-K/-S)

Power consumption  
 N-50, N-50-K/-S . . . . . 34 W  
 N-30, N-30-K/-S . . . . . 31 W  
 Power consumption (In standby mode). . . . . 0.3 W  
 Weight (without package)  
 N-50, N-50-K/-S . . . . . 7.3 kg (16.1 lb)  
 N-30, N-30-K/-S . . . . . 5.0 kg (11 lb)

Dimensions  
 N-50, N-50-K/-S  
 . . . . . 435 mm (W) x 99 mm (H) x 330 mm (D)  
 (17 3/16 in. (W) x 3 15/16 in. (H) x 13 in. (D))  
 N-30, N-30-K/-S  
 . . . . . 435 mm (W) x 97.5 mm (H) x 330 mm (D)  
 (17 3/16 in. (W) x 3 15/16 in. (H) x 13 in. (D))

Operating temperature. . . . . +5 °C to +35 °C  
 Operating humidity. . . . . 5 % to 85 %

#### •Network

Ethernet interface. . . . . 10 BASE-T/100 BASE-TX  
 DLNA. . . . . Ver 1.5 (DMP/DMR)

#### •Analog audio output

Output level (During audio output)  
 . . . . . 2 V rms (1 kHz, 0 dB)  
 Number of channels. . . . . 2  
 Jack . . . . . RCA  
 Frequency response. . . . . 4 Hz to 80 kHz –3 dB  
 Signal-to-Noise Ratio  
 1 kHz, 0 dB, fs 192 kHz . . . . . >111 dB  
 Dynamic range  
 1 kHz, 0 dB, fs 192 kHz . . . . . >111 dB  
 Total harmonic distortion  
 1 kHz, 0 dB, fs 192 kHz . . . . . <0.002 %  
 Channel separation  
 1 kHz, 0 dB, fs 192 kHz . . . . . >105 dB

#### •Digital audio output

Coaxial digital output. . . . . RCA jack  
 Optical digital output . . . . . Optical digital jack

#### •Digital audio input (N-50, N-50-K/-S only)

Coaxial digital input . . . . . RCA jack  
 Optical digital input . . . . . Optical digital jack  
 USB type-B . . . . . USB 2.0 HS



#### Note

- Specifications and the design are subject to possible modifications without notice, due to improvements.
- This product is not designed for use in Japan.

## 2.3 PLAYABLE FILE FORMATS

This unit supports the following file formats.

- A
  - Note that some file formats are not available for playback although they are listed as playable file formats.
  - If an attempt is made to play files with unsupported formats, the sound may be intermittent or be accompanied by noise. In such cases, confirm that the file format is compatible with this unit.
  - The compatibility of file formats varies depending on the type of server. Check with your server to ensure the compatibility of file formats supported by your server.
- B
  - Depending on the server, some file types not supported by this unit may be converted and output. For details, consult the server's operating instructions.
  - Internet radio playback may be affected by the Internet communications environment, and in this case playback may not be possible even with the file formats listed here

Category	Extension	Stream
C		Sampling frequency 32kHz to 48kHz <hr/> Quantization bitrate 16bit <hr/> Channel 2ch <hr/> Bitrate 8kbps to 320kbps <hr/> VBR/CBR Supported/Supported
D		Sampling frequency 32kHz to 48kHz <hr/> Quantization bitrate 16bit <hr/> Channel 2ch <hr/> Sampling frequency 32kHz to 192kHz (Music Server) <hr/> 32kHz to 96kHz (USB) <hr/> Quantization bitrate 16bit, 20bit, 24bit <hr/> Channel 2ch <hr/> Sampling frequency 32kHz to 48kHz <hr/> Quantization bitrate 16bit <hr/> Channel 2ch <hr/> Bitrate 5kbps to 320kbps <hr/> VBR/CBR Supported/Supported

Category	Extension	Stream
C		Sampling frequency 32kHz to 48kHz <hr/> Quantization bitrate 16bit <hr/> Channel 2ch <hr/> Bitrate 8kbps to 320kbps <hr/> VBR/CBR Supported/Supported
D		Sampling frequency 32kHz to 48kHz <hr/> Quantization bitrate 16bit <hr/> Channel 2ch <hr/> Sampling frequency 32kHz to 192kHz (Music Server) <hr/> 32kHz to 96kHz (USB) <hr/> Quantization bitrate 16bit, 20bit, 24bit <hr/> Channel 2ch <hr/> Sampling frequency 32kHz to 48kHz <hr/> Quantization bitrate 16bit <hr/> Channel 2ch <hr/> Bitrate 5kbps to 320kbps <hr/> VBR/CBR Supported/Supported

MP3  
<\*1> .mp3

MPEG-1  
Audio  
Layer-3

Category	Extension	Stream
		Sampling frequency 32kHz to 48kHz (Internet Radio) <hr/> 44.1 kHz, 48 kHz, 88.2 kHz, 96 kHz, 192 kHz (Digital In USB) <hr/> Quantization bitrate 16bit (Internet Radio) <hr/> 16bit, 24bit, 32bit (Digital In USB) <hr/> Channel 2ch
LPCM	— <*2>	LPCM
		Sampling frequency 32kHz to 48kHz <hr/> Quantization bitrate 16bit <hr/> Channel 2ch
		Sampling frequency 32kHz to 192kHz (Music Server) <hr/> 32kHz to 96kHz (USB) <hr/> Quantization bitrate 16bit, 20bit, 24bit <hr/> Channel 2ch
WAV	.wav	LPCM
		Sampling frequency 32kHz to 48kHz <hr/> Quantization bitrate 16bit <hr/> Channel 2ch
		Sampling frequency 32kHz to 48kHz <hr/> Quantization bitrate 16bit <hr/> Channel 2ch <hr/> Bitrate 5kbps to 320kbps <hr/> VBR/CBR Supported/Supported
WMA	.wma	WMA2/7/8/9/10

5

6

7

8

Category	Extension	Stream		
AAC	.m4a .aac .3gp .3g2	MPEG-4 AAC MPEG-4 HE AAC (AAC Plus v1/2)	Sampling frequency	32kHz to 48kHz
			Quantization bitrate	16bit
			Channel	2ch
			Bitrate	16kbps to 320kbps
			VBR/CBR	Supported/Supported
FLAC	.flac	FLAC	Sampling frequency	32 kHz to 192kHz (Music Server)
				32kHz to 96kHz (USB)
			Quantization bitrate	16bit, 24bit
			Channel	2ch

\*1 "MPEG Layer-3 audio decoding technology licensed from Fraunhofer IIS and Thomson multimedia."

\*2 Only streaming data from servers is concerned, so there is no extension.

### About network playback

The network playback function such as Internet Radio or Music Server of this unit uses the following technologies:

### Windows Media Player

Windows Media Player 11/Windows Media Player 12.

### Windows Media DRM

Microsoft Windows Media Digital Rights Management (WMDRM) is a platform to protect and securely deliver content for playback on computers, portable devices and network devices. Music Server functions as a WMDRM 10 for networked devices. WMDRM protected content can only be played on media servers supporting WMDRM.

*Content owners use WMDRM technology to protect their intellectual property, including copyrights. This device uses WMDRM software to access WMDRM protected content. If the WMDRM software fails to protect the content, content owners may ask Microsoft to revoke the software's ability to use WMDRM to play or copy protected content. Revocation does not affect unprotected content. When you download licenses for protected content, you agree that Microsoft may include a revocation list with the licenses. Content owners may require you to upgrade WMDRM to access their content. If you decline an upgrade, you will not be able to access content that requires the upgrade.*

*This product is protected by certain intellectual property rights of Microsoft. Use or distribution of such technology outside of this product is prohibited without a license from Microsoft.*

### DLNA



DLNA CERTIFIED® Audio Player

N-50

5

6

7

8

7

The Digital Living Network Alliance (DLNA) is a cross-industry organization of consumer electronics, computing industry and mobile device companies. Digital Living provides consumers with easy sharing of digital media through a wired or wireless network in the home.

The DLNA certification logo makes it easy to find products that comply with the DLNA Interoperability Guidelines. This unit complies with DLNA Interoperability Guidelines v1.5.

When a PC running DLNA server software or other DLNA compatible device is connected to this player, some setting changes of software or other devices may be required. Please refer to the operating instructions for the software or device for more information.

*DLNA®*, *the DLNA Logo* and *DLNA CERTIFIED®* are trademarks, service marks, or certification marks of the Digital Living Network Alliance.

**Content playable over a network**

- Even when encoded in a compatible format, some files may not play correctly.
- Movie or Photo files cannot be played back.
- There are cases where you cannot listen to an Internet radio station even if the station can be selected from a list of radio stations.
- Some functions may not be supported depending on the server type or version used.
- Supported file formats vary by server. As such, files not supported by your server are not displayed on this unit. For more information check with the manufacturer of your server.

**Disclaimer for Third Party Content**

N-50/N-30 only

ACCESS TO THIRD PARTY CONTENT SERVICES, INCLUDING ALL ASSOCIATED FEATURES AND FUNCTIONALITIES, IS PROVIDED "AS IS," "AS AVAILABLE" AND AT THE USER'S OWN RISK, WITHOUT WARRANTY OF ANY KIND. PIONEER DISCLAIMS ALL WARRANTIES, EXPRESS OR IMPLIED, IN CONNECTION WITH ACCESS TO AND USE OF CONTENT SERVICES THROUGH THIS DEVICE, INCLUDING WITHOUT LIMITATION WARRANTIES OF MERCHANTABILITY, SATISFACTORY QUALITY, FITNESS FOR A PARTICULAR PURPOSE, AND NON-INFRINGEMENT. PIONEER DOES NOT GUARANTEE, REPRESENT, OR WARRANT THAT CONTENT SERVICES WILL BE FREE FROM ERRORS, INTERRUPTION, LOSS, CORRUPTION, ATTACK, VIRUSES, INTERFERENCE, HACKING, OR OTHER SECURITY INTRUSION, AND PIONEER DISCLAIMS ANY LIABILITY IN CONNECTION WITH THE FOREGOING. PIONEER IS NOT LIABLE OR RESPONSIBLE FOR ANY LOSS OR DAMAGE ARISING

FROM ACCESS TO OR USE OF CONTENT. NO ORAL OR WRITTEN INFORMATION OR ADVICE GIVEN BY PIONEER OR ITS CUSTOMER SERVICES REPRESENTATIVES WILL CREATE ANY SUCH WARRANTY. IN NO EVENT WILL PIONEER, ITS AFFILIATES, OR THEIR RESPECTIVE OFFICERS, DIRECTORS, OR EMPLOYEES BE LIABLE IN CONNECTION WITH YOUR USE OF THIRD PARTY CONTENT SERVICES THROUGH THIS DEVICE FOR PERSONAL INJURY OR SPECIAL, INCIDENTAL, INDIRECT OR CONSEQUENTIAL DAMAGES OF ANY KIND, INCLUDING WITHOUT LIMITATION DAMAGES FOR ATTORNEY'S FEES, LOST DATA OR LOST PROFITS, REGARDLESS OF THE THEORY OF LIABILITY AND WHETHER OR NOT ADVISED OF THE POSSIBILITY OF SUCH DAMAGES. IN NO EVENT WILL PIONEER'S TOTAL LIABILITY TO YOU FOR ALL DAMAGES ARISING FROM THE USE OR INABILITY TO USE THIRD PARTY CONTENT SERVICES (OTHER THAN AS MAY BE REQUIRED BY LAW IN CASES INVOLVING PERSONAL INJURY) EXCEED \$10.00. THE FOREGOING LIMITATIONS WILL APPLY EVEN IF THE ABOVE REMEDY FAILS OF ITS ESSENTIAL PURPOSE. IF ANY APPLICABLE AUTHORITY HOLDS ANY PORTION OF THIS SECTION TO BE UNENFORCEABLE, THEN LIABILITY WILL BE LIMITED TO THE MAXIMUM EXTENT PERMITTED BY APPLICABLE LAW.

N-50/N-30 only

**Disclaimer for Third Party Content**

Access to content provided by third parties requires a high speed internet connection and may also require account registration and a paid subscription. Therd party content services may be changed, suspended, interrupted, or discontinued at any time without notice, and Pionner disclaims any liability in connection with such occurrences. Pionner does not represent or warrant that content services will continue to be provided or available for a particular period of time, and any such warranty, express or implied, is disclaimed.

N-50-K/-S, N-30-K/-S only

**About playback behavior over a network**

- Playback may stall when the PC is switched off or any media files stored on it are deleted while playing content.
- If there are problems within the network environment (heavy network traffic, etc.) content may not be displayed or played properly (playback may be interrupted or stalled). For best performance, a 100BASE-TX connection between player and PC is recommended.
- If several clients are playing simultaneously, as the case may be, playback is interrupted or stalled.
- Depending on the security software installed on a connected PC and the setting of such software, network connection may be blocked.



Pioneer is not responsible for any malfunction of the player and/or the Music Server features due to communication error/malfunctions associated with your network connection and/or your PC, or other connected equipment. Please contact your PC manufacturer or Internet service provider.

*Windows Media is either a registered trademark or trademark of Microsoft Corporation in the United States and/or other countries.*

*This product includes technology owned by Microsoft Corporation and cannot be used or distributed without a license from Microsoft Licensing, Inc.*

*Microsoft<sup>®</sup>, Windows<sup>®</sup>7, Windows<sup>®</sup>Vista, Windows<sup>®</sup>XP, Windows<sup>®</sup>2000, Windows<sup>®</sup>Millennium Edition, Windows<sup>®</sup>98, and WindowsNT<sup>®</sup> are either registered trademarks or trademarks of Microsoft Corporation in the United States and/or other countries.*

### Authorizing this unit

In order to be able to play with Music Server, this unit must be authorized. This happens automatically when the unit makes a connection over the network to the PC. If not, please authorize this unit manually on the PC.

The authorization (or permission) method for access varies depending on the type of server currently being connected. For more information on authorizing this unit, refer to the instruction manual of your server.

### aacPlus



The AAC decoder uses aacPlus developed by Coding Technologies

([www.codingtechnologies.com](http://www.codingtechnologies.com)).

### FLAC

FLAC Decoder

Copyright c 2000, 2001, 2002, 2003, 2004, 2005, 2006, 2007  
Josh Coalson

Redistribution and use in source and binary forms, with or without modification, are permitted provided that the following conditions are met:

- Redistributions of source code must retain the above copyright notice, this list of conditions and the following disclaimer.
- Redistributions in binary form must reproduce the above copyright notice, this list of conditions and the following disclaimer in the documentation and/or other materials provided with the distribution.
- Neither the name of the Xiph.org Foundation nor the names of its contributors may be used to endorse or promote products derived from this software without specific prior written permission.

THIS SOFTWARE IS PROVIDED BY THE COPYRIGHT HOLDERS AND CONTRIBUTORS "AS IS" AND ANY EXPRESS OR IMPLIED WARRANTIES, INCLUDING, BUT NOT LIMITED TO, THE IMPLIED WARRANTIES OF MERCHANTABILITY AND FITNESS FOR A PARTICULAR PURPOSE ARE DISCLAIMED. IN NO EVENT SHALL THE FOUNDATION OR CONTRIBUTORS BE LIABLE FOR ANY DIRECT, INDIRECT, INCIDENTAL, SPECIAL, EXEMPLARY, OR CONSEQUENTIAL DAMAGES (INCLUDING, BUT NOT LIMITED TO, PROCUREMENT OF SUBSTITUTE GOODS OR SERVICES; LOSS OF USE, DATA, OR PROFITS; OR BUSINESS INTERRUPTION) HOWEVER CAUSED AND ON ANY THEORY OF LIABILITY, WHETHER IN CONTRACT, STRICT LIABILITY, OR TORT (INCLUDING NEGLIGENCE OR OTHERWISE) ARISING IN ANY WAY OUT OF THE USE OF THIS SOFTWARE, EVEN IF ADVISED OF THE POSSIBILITY OF SUCH DAMAGE.

### About iPod/iPhone/iPad



"Made for iPod", "Made for iPhone" and "Made for iPad" mean that an electronic accessory has been designed to connect specifically to iPod, iPhone or iPad, respectively, and has been certified by the developer to meet Apple performance standards. Apple is not responsible for the operation of this device or its compliance with safety and regulatory standards. Please note that the use of this accessory with iPod, iPhone, or iPad may affect wireless performance.

*Apple, AirPlay, the AirPlay logo, iPad, iPhone, iPod, iPod shuffle, iPod nano, iPod classic, iPod touch, iTunes and Mac are trademarks of Apple, Inc., registered in the U.S. and other countries.*

1 2 3 4

# 3. BASIC ITEMS FOR SERVICE

## 3.1 CHECK POINTS AFTER SERVICING

A To keep the product quality after servicing, confirm recommended check points shown below.

No.	Procedures	Check points
1	Confirm a firmware version at test mode.	Should be the latest firmware version. If not, update the version.
2	Confirm whether the customer complain has been solved. If the indicated complain is caused by a specific file format, replay a music file for test of the same format as target file.	The customer complain must not be reappeared. No abnormalities should exist in screen displayed contents, audio and actions.
3	Confirm replay of a music file for test with the same format as corresponding file format at the front USB terminal. (Confirm music files with all file formats should be replayed.)	No abnormalities should exist in actions such as audio, screen display, etc.
4	Check the external package	No scratches or dirt on its appearance after receiving it for service.

B

A music file for test with corresponding file format should be used after downloading from the service dedicated Web Site onto an USB memory, etc.

See the table below for the items to be checked regarding audio.

Item to be checked regarding audio
Distortion
Noise
Volume too low
Volume too high
Volume fluctuating
Sound interrupted

C

D

E

F

10

N-50

1 2 3 4

5 6 7 8

## 3.2 PCB LOCATIONS

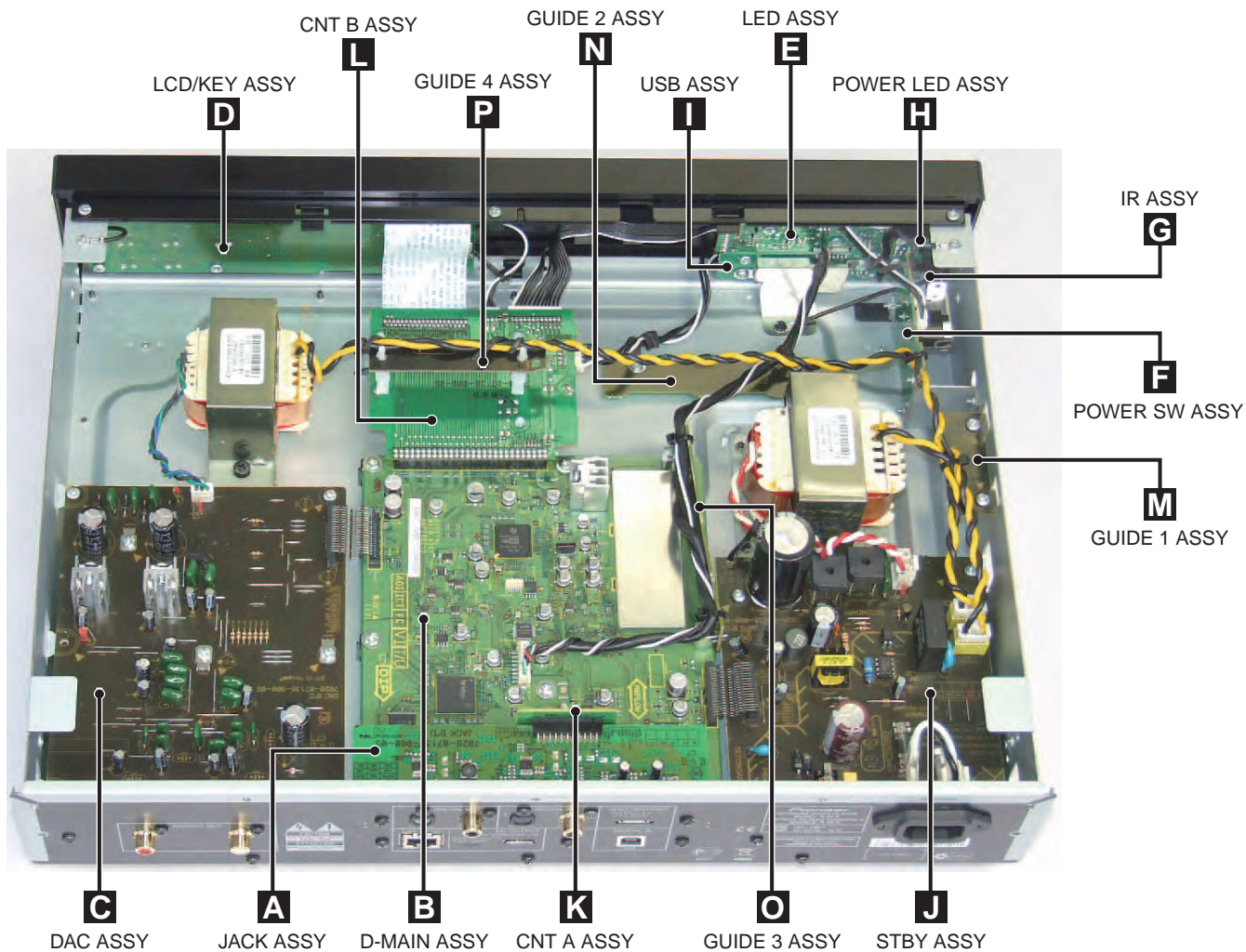

NOTES: ● Parts marked by "NSP" are generally unavailable because they are not in our Master Spare Parts List.

- The ⚠ mark found on some component parts indicates the importance of the safety factor of the part. Therefore, when replacing, be sure to use parts of identical designation.

A

Mark No.	Description	Part No.	Mark No.	Description	Part No.
<b>LIST OF ASSEMBLIES</b>					
NSP	1..TTL ASSY D-MAIN(N-50) 2..D-MAIN ASSY	7025HU1103040-IL 7028071361010-IL	NSP	1..TTL ASSY DAC(N-30) 2..GUIDE 4 ASSY 2..DAC ASSY	7025HU1102032-IL 702807138B010-IL 7028071381020-IL
NSP	1..TTL ASSY D-MAIN(N-50-K/-S) 2..D-MAIN ASSY	7025HU1103030-IL 7028071361010-IL	⚠	2..STBY ASSY 2..LED ASSY 2..POWER LED ASSY 2..POWER SW ASSY	7028071382030-IL 7028071383020-IL 7028071384010-IL 7028071385010-IL
NSP	1..TTL ASSY D-MAIN(N-30) 2..D-MAIN ASSY	7025HU1102030-IL 7028071361020-IL	NSP	2..IR ASSY 2..GUIDE 3 ASSY 2..CNT B ASSY 2..GUIDE 1 ASSY	7028071386010-IL 7028071387010-IL 7028071388010-IL 7028071389010-IL
NSP	1..TTL ASSY D-MAIN(N-30-K/-S) 2..D-MAIN ASSY	7025HU1102040-IL 7028071361020-IL	NSP	1..TTL ASSY DAC(N-30-K/-S) 2..GUIDE 4 ASSY 2..DAC ASSY	7025HU1102042-IL 702807138B010-IL 7028071381020-IL
NSP	1..TTL ASSY USB(N-50) 2..USB ASSY	7025HU1103041-IL 7028071371010-IL	⚠	2..STBY ASSY 2..LED ASSY 2..POWER LED ASSY 2..POWER SW ASSY 2..IR ASSY	7028071382040-IL 7028071383020-IL 7028071384010-IL 7028071385010-IL 7028071386010-IL
NSP	1..TTL ASSY USB(N-50-K/-S) 2..USB ASSY	7025HU1103031-IL 7028071371010-IL	NSP	2..GUIDE 3 ASSY 2..CNT B ASSY 2..GUIDE 1 ASSY	7028071387010-IL 7028071388010-IL 7028071389010-IL
NSP	1..TTL ASSY USB(N-30) 2..USB ASSY	7025HU1102031-IL 7028071371010-IL	NSP	1..TTL ASSY JACK(N-50) 2..JACK ASSY 2..LCD/KEY ASSY 2..CNT A ASSY	7025HU1103043-IL 7028071391010-IL 7028071392010-IL 7028071393010-IL
NSP	1..TTL ASSY USB(N-30-K/-S) 2..USB ASSY	7025HU1102041-IL 7028071371010-IL	NSP	1..TTL ASSY JACK(N-50-K/-S) 2..JACK ASSY 2..LCD/KEY ASSY 2..CNT A ASSY	7025HU1103033-IL 7028071391010-IL 7028071392010-IL 7028071393010-IL
NSP	1..TTL ASSY DAC(N-50) 2..GUIDE 2 ASSY 2..GUIDE 4 ASSY 2..DAC ASSY	7025HU1103042-IL 702807138A010-IL 702807138B010-IL 7028071381010-IL	NSP	1..TTL ASSY JACK(N-30) 2..JACK ASSY 2..LCD/KEY ASSY 2..CNT A ASSY	7025HU1102033-IL 7028071391020-IL 7028071392010-IL 7028071393010-IL
⚠	2..STBY ASSY 2..LED ASSY 2..POWER LED ASSY 2..POWER SW ASSY 2..IR ASSY	7028071382010-IL 7028071383010-IL 7028071384010-IL 7028071385010-IL 7028071386010-IL	NSP	1..TTL ASSY JACK(N-30-K/-S) 2..JACK ASSY 2..LCD/KEY ASSY 2..CNT A ASSY	7025HU1102043-IL 7028071391020-IL 7028071392010-IL 7028071393010-IL
⚠	2..GUIDE 3 ASSY 2..CNT B ASSY 2..GUIDE 1 ASSY	7028071387010-IL 7028071388010-IL 7028071389010-IL			
NSP	1..TTL ASSY DAC(N-50-K/-S) 2..GUIDE 2 ASSY 2..GUIDE 4 ASSY 2..DAC ASSY	7025HU1103032-IL 702807138A010-IL 702807138B010-IL 7028071381010-IL			
⚠	2..STBY ASSY 2..LED ASSY 2..POWER LED ASSY 2..POWER SW ASSY 2..IR ASSY	7028071382020-IL 7028071383010-IL 7028071384010-IL 7028071385010-IL 7028071386010-IL			
NSP	2..GUIDE 3 ASSY 2..CNT B ASSY 2..GUIDE 1 ASSY	7028071387010-IL 7028071388010-IL 7028071389010-IL			

E

### 3.3 JIGS LIST

Name	Jig No.	Remarks
Service Remote Control Unit	GGF1381	Adjustment, Diagnosis

F

■

5

■

6

■

7

■

8

■

A

■

B

■

C

■

D

■

E

■

F

■

5

■

6

N-50

■

7

■

8

■

# 4. BLOCK DIAGRAM

## 4.1 OVERALL CONNECTION DIAGRAM (1/2)

**J STBY ASSY**  
 (N-50 :7028071382010-IL)  
 (N-50-K/-S :7028071382020-IL)  
 (N-30 :7028071382030-IL)  
 (N-30-K/-S :7028071382040-IL)

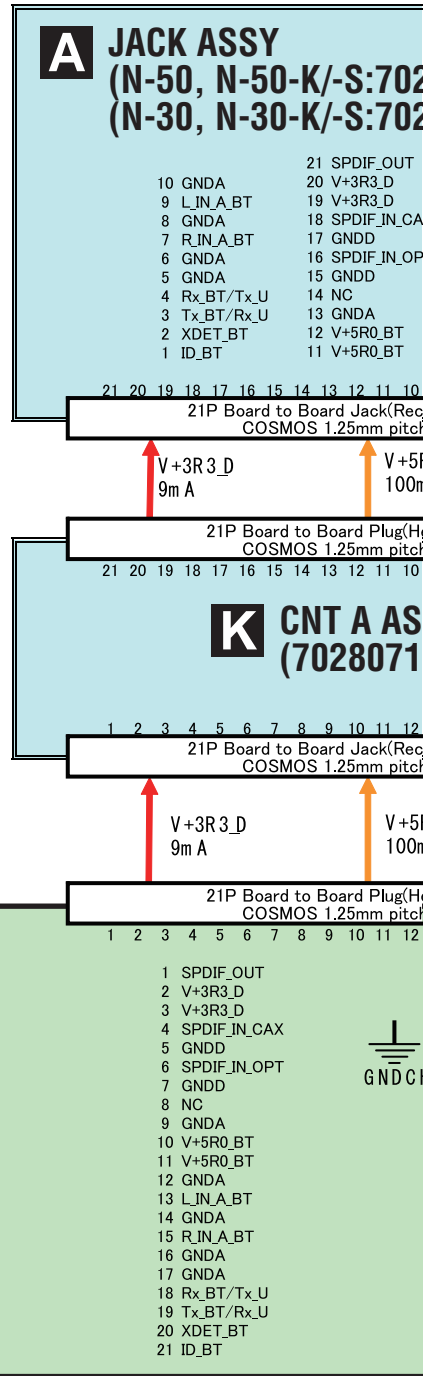

A  
B  
C  
D  
E  
F

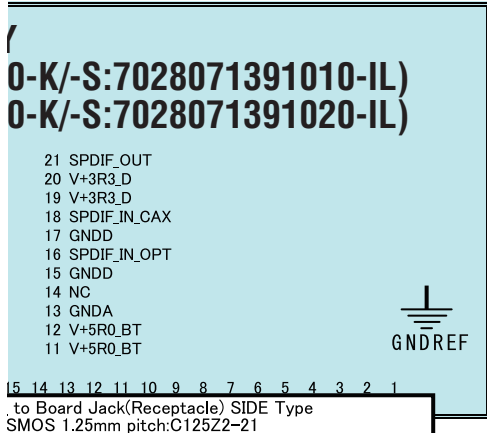

Board to Board

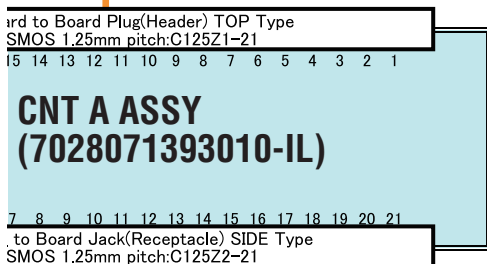

Board to Board

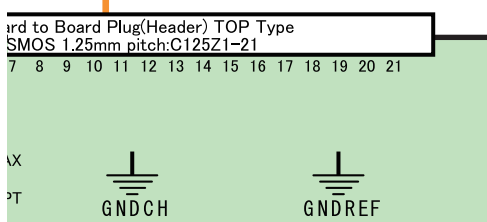

**B (B1/5 - B5/5)**  
**D-MAIN ASSY (1/2)**  
**(N-50, N-50-K/-S:7028071361010-IL)**  
**(N-30, N-30-K/-S:7028071361020-IL)**

**C DAC ASSY**  
**(N-50, N-50-K/-S:7028071381010-IL)**  
**(N-30, N-30-K/-S:7028071381020-IL)**

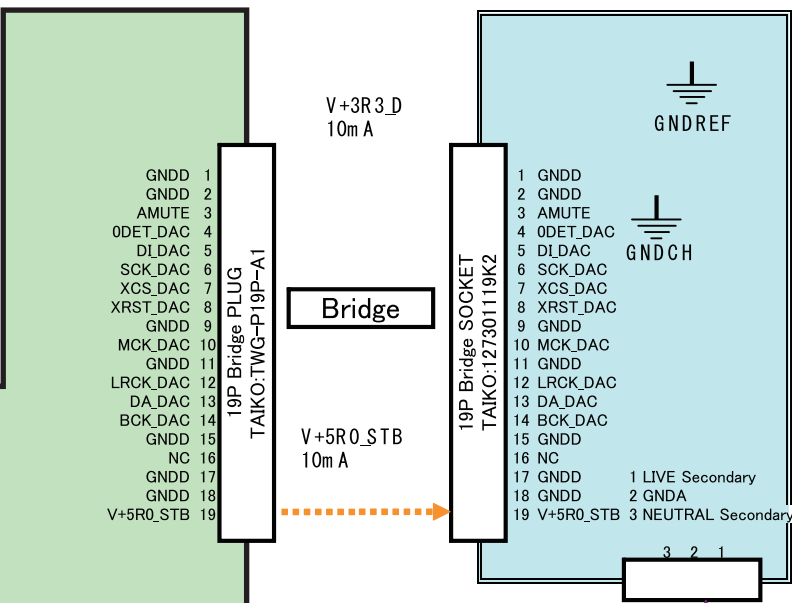

Cable

● When ordering service parts, be sure to refer to "EXPLODED VIEWS and PARTS LIST" or "PCB PARTS LIST".  
 ● The ⚠ mark found on some component parts indicates the importance of the safety factor of the part.  
 Therefore, when replacing, be sure to use parts of identical designation.

## 4.2 OVERALL CONNECTION DIAGRAM (2/2)

A

**M** GUIDE 1 ASSY  
(7028071389010-IL)

**N** GUIDE 2 ASSY  
(N-50, N-50-K/-S:702807138A010-IL)

**O** GUIDE 3 ASSY  
(7028071387010-IL)

**P** GUIDE 4 ASSY  
(702807138B010-IL)

C

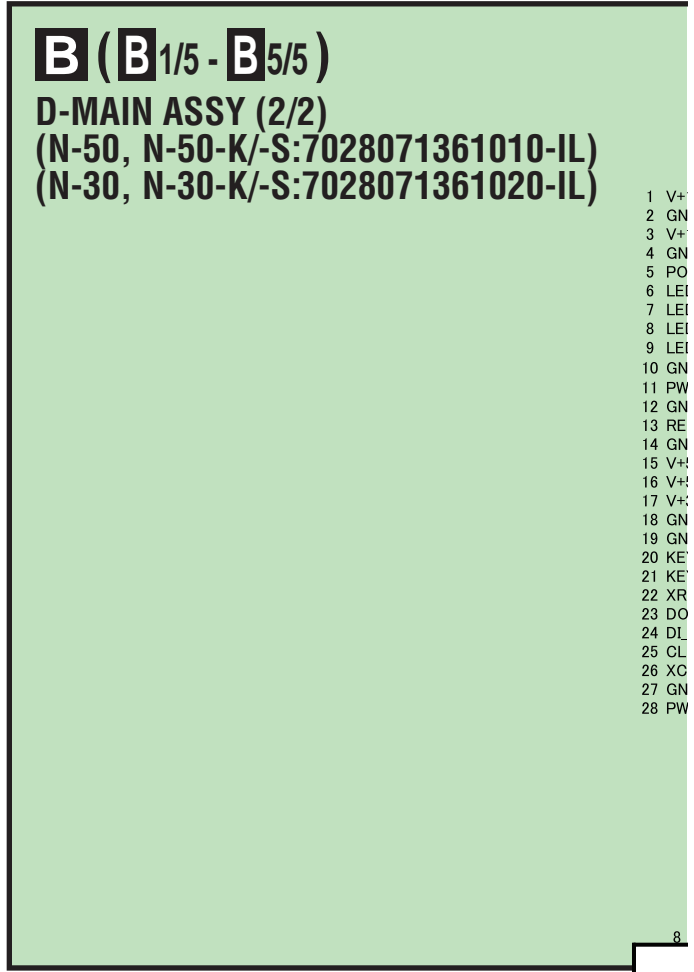

D

**L** CNT B ASSY  
(7028071388010-IL)

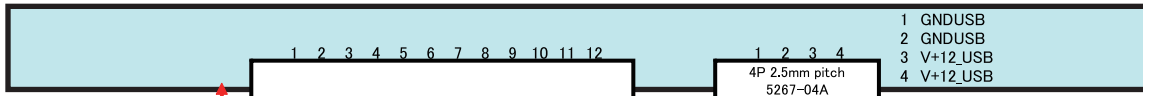

E

**H** POWER LED ASSY  
(7028071384010-IL)

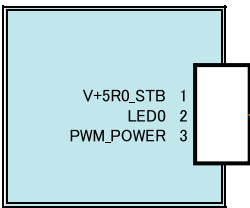

E

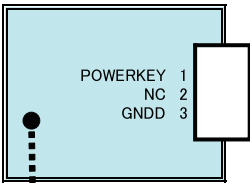

F

**F** POWER SW ASSY  
(7028071385010-IL)

**E** LED ASSY  
(N-50, N-50-K/-S:7028071383010-IL)  
(N-30, N-30-K/-S:7028071383020-IL)

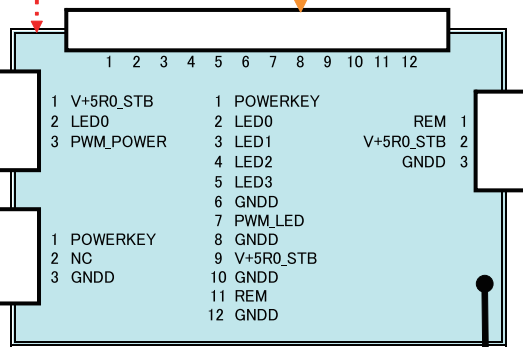

**G** IR ASSY  
(70280713)

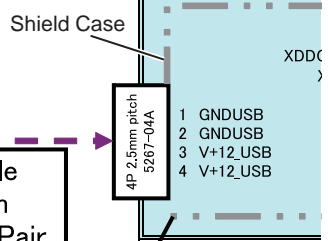
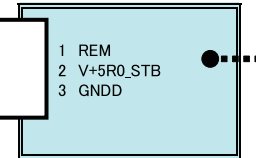

**I** USB  
(702)

Direct connection(Chass



A  
B  
C  
D  
E  
F

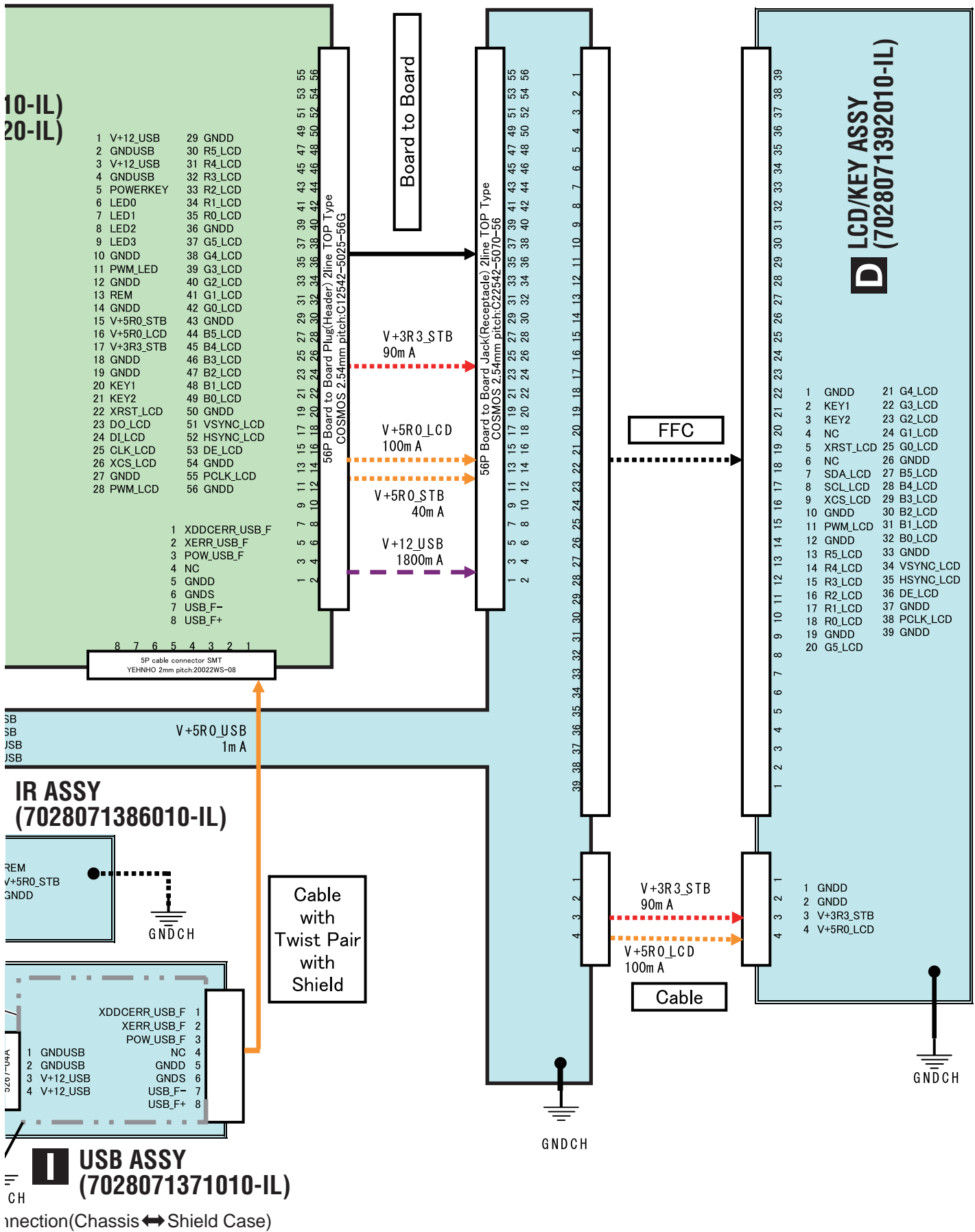

# 4.3 BLOCK DIAGRAM

1

2

3

4

A

B

C

D

E

F

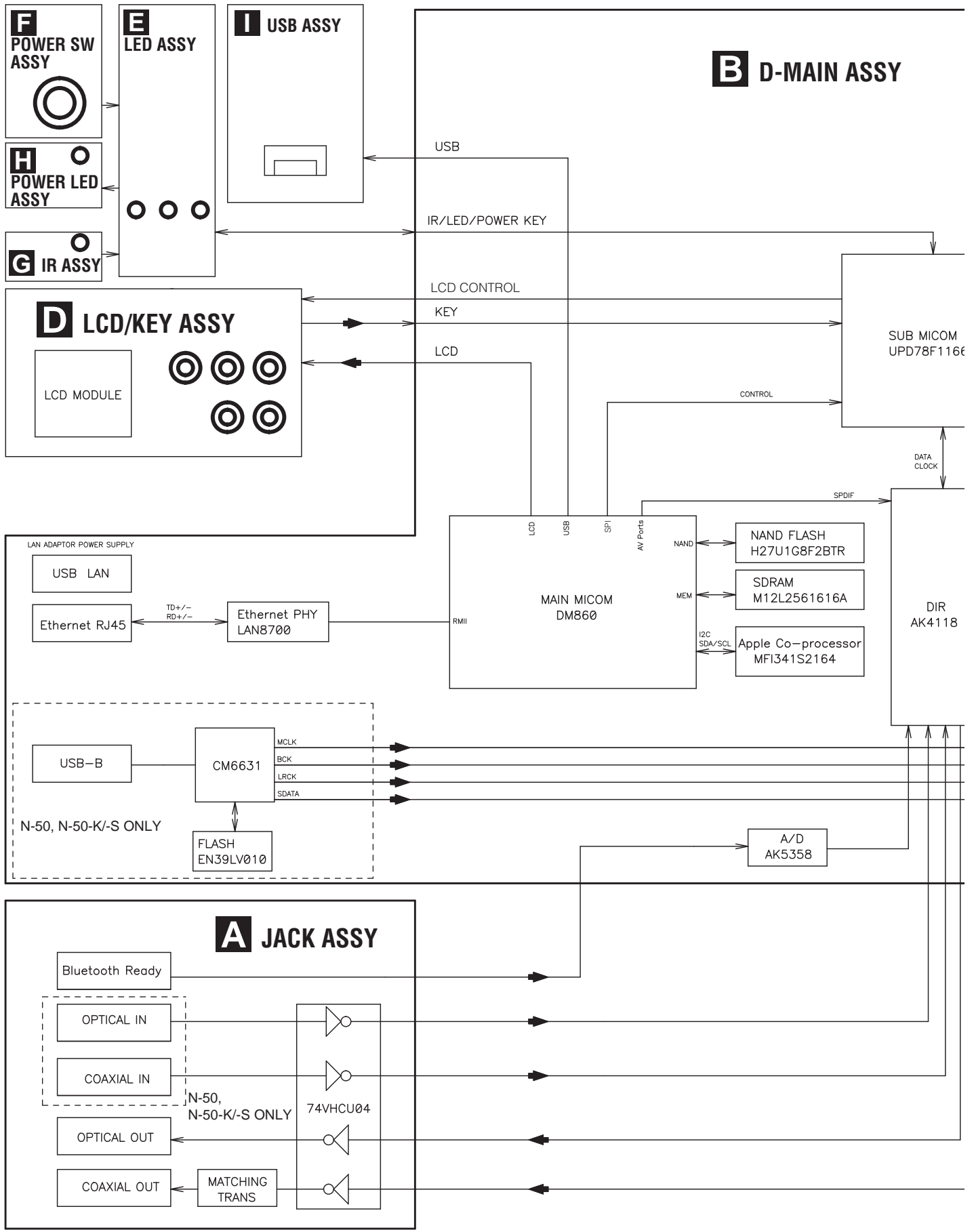

1

2

3

4

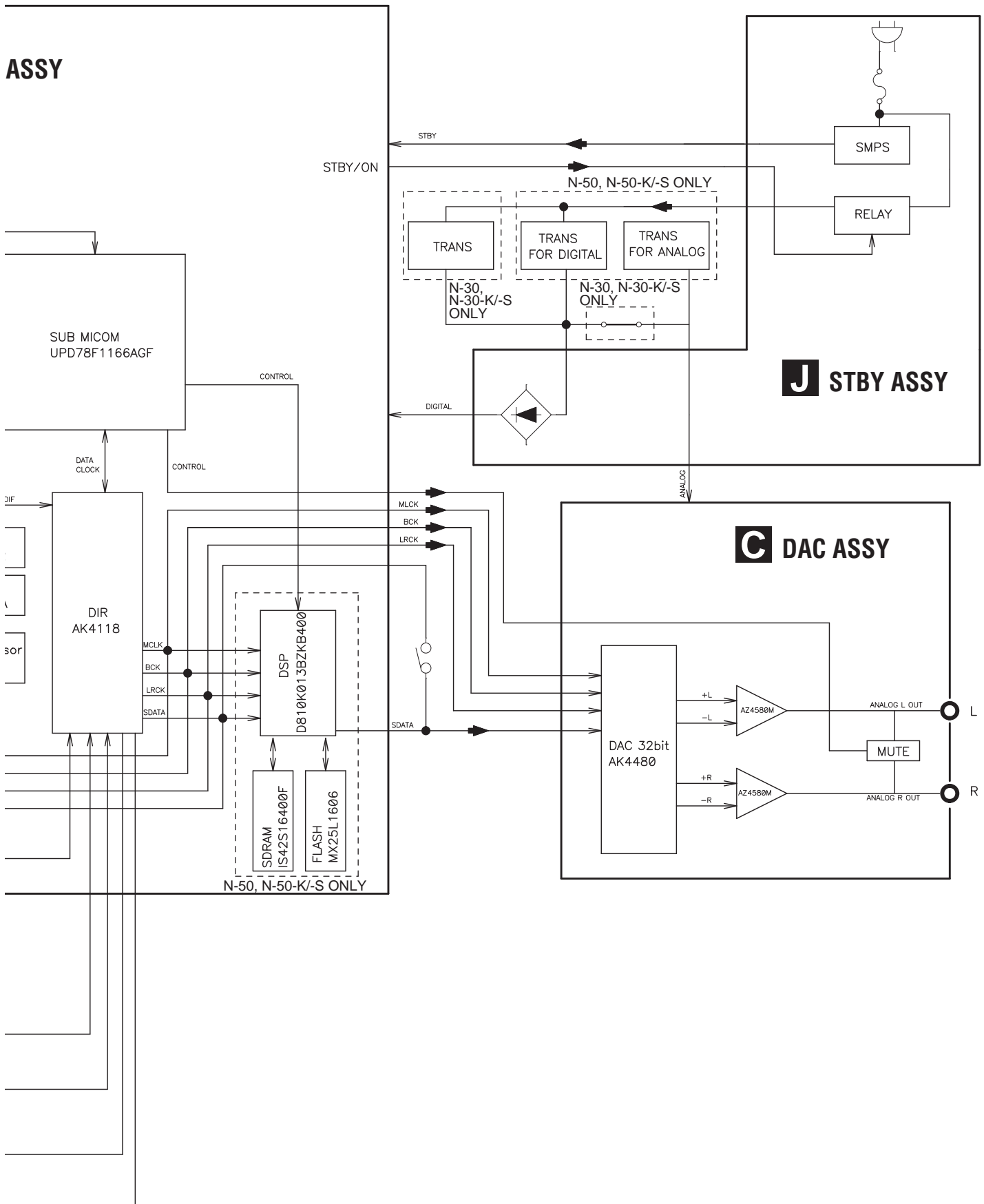

A  
B  
C  
D  
E  
F

# 5. DIAGNOSIS

## 5.1 TROUBLESHOOTING

### A No sound comes out.

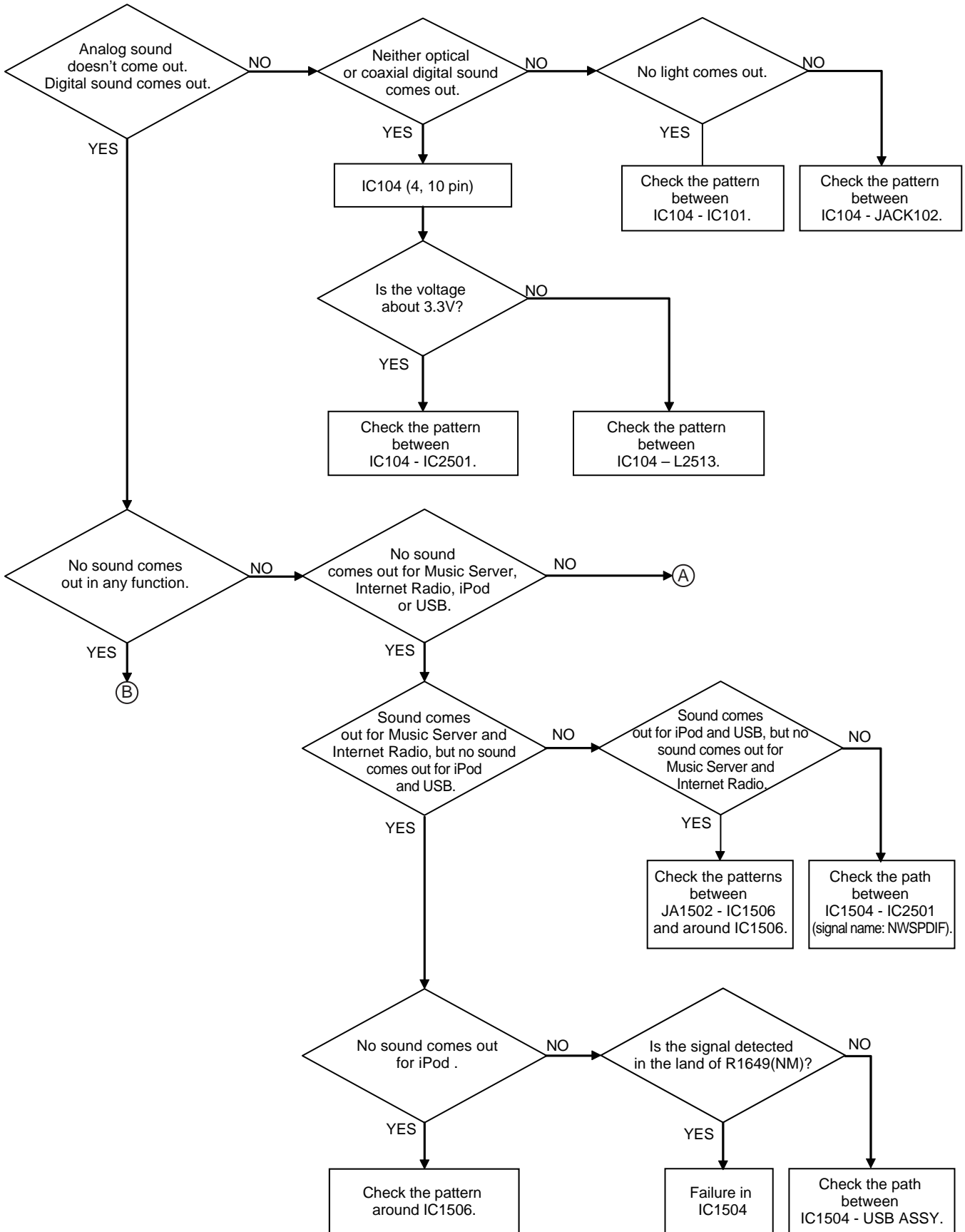

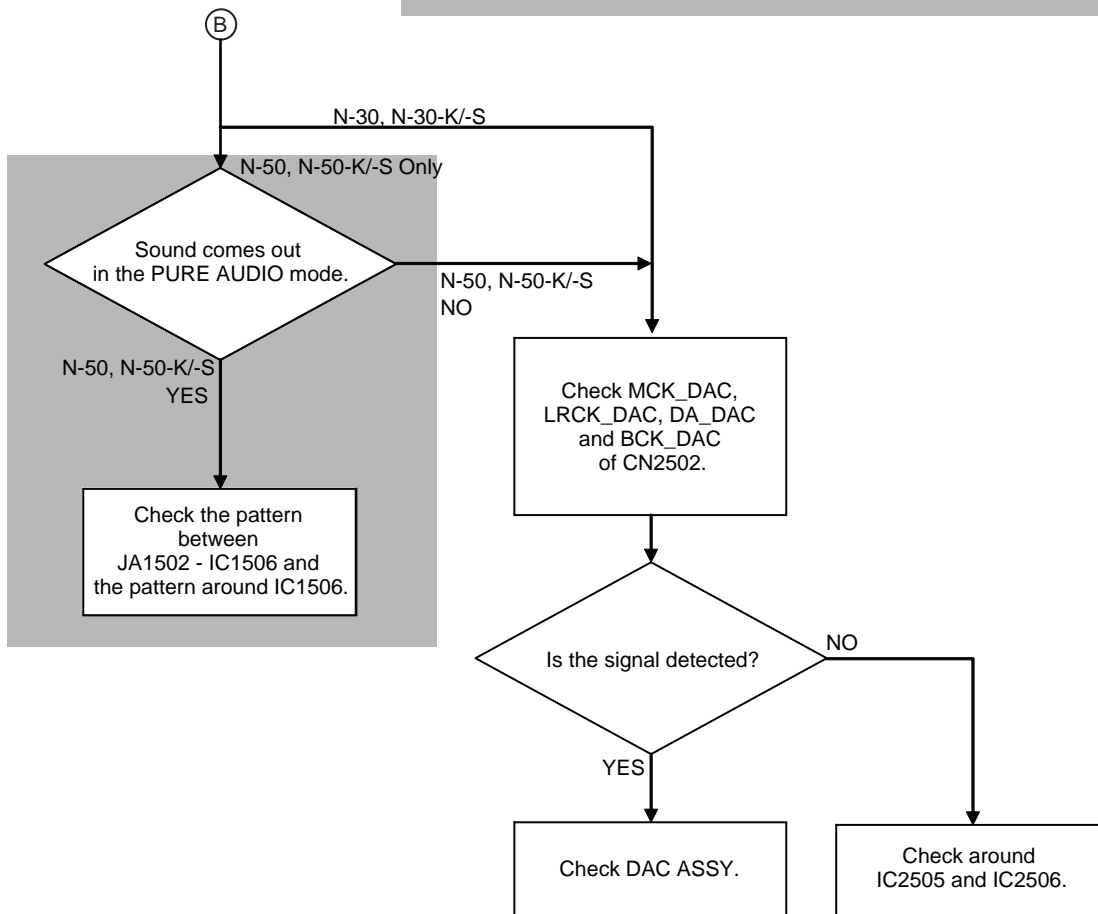
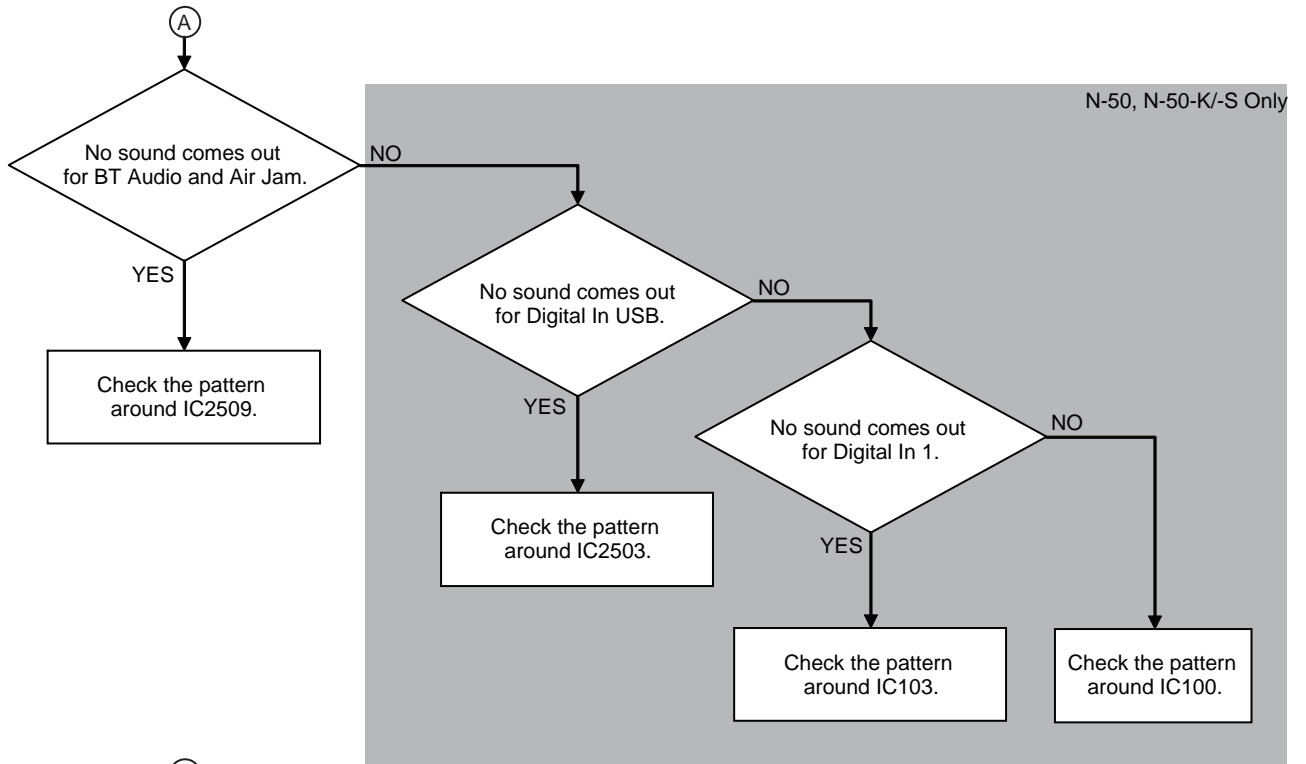

### No power comes on.

A

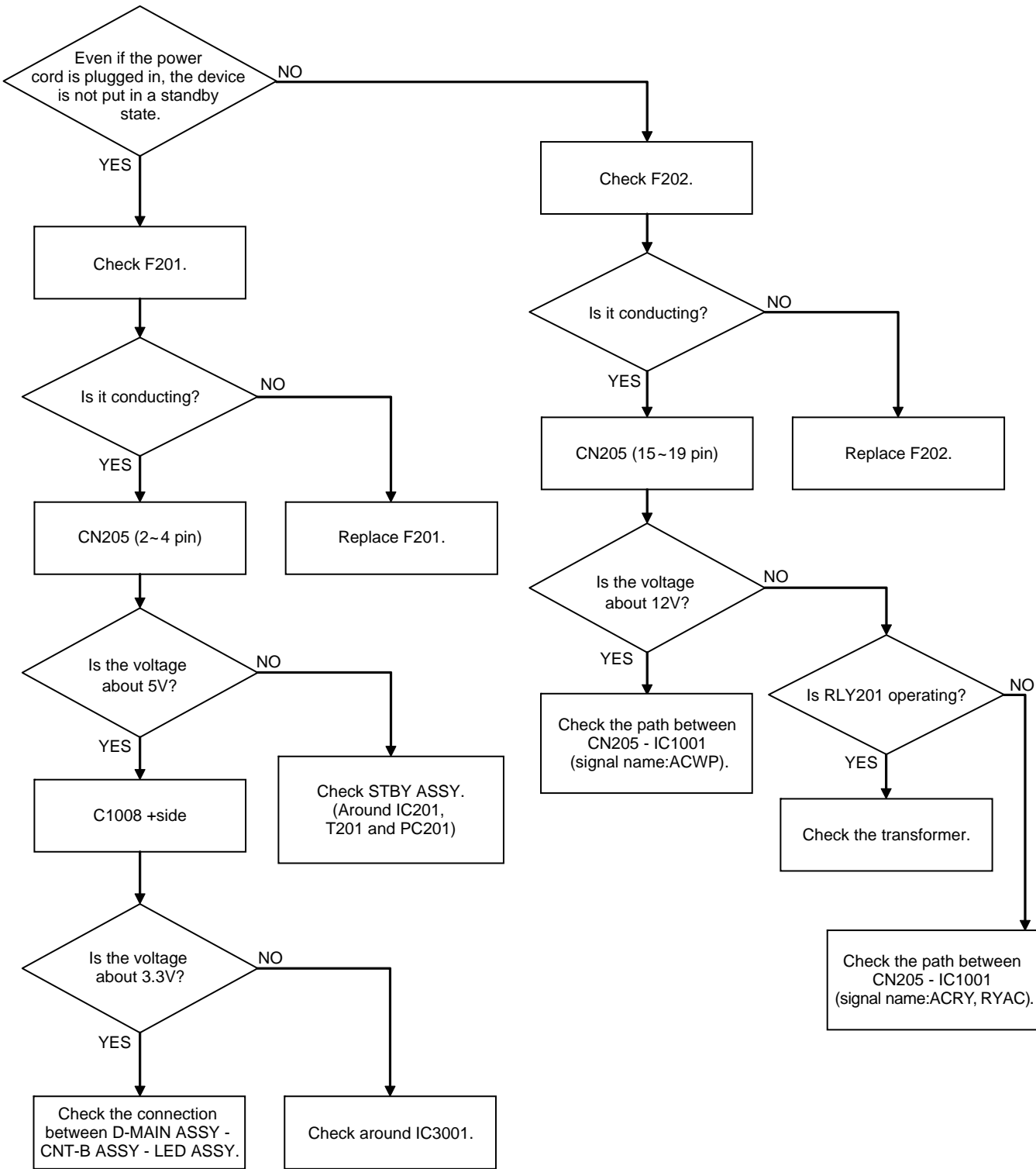

B

C

D

E

F

## 5.2 PROTECTION CIRCUIT ERROR DETECTION

Item	GUI display	LED display	Number of NGs	Detection method	Processing after detection	Return processing	Remark
AC Detection	-	-	-	The presence or absence of power supply is detected. At the same time, occurrence of AC instantaneous interruption is also detected. AC_DET (Sub/IC1001-81 pin) "H" detection	After detection, execute AC_OFF processing, and the power is turned OFF.		
BT Module Over Current Detection	BT error 5	-	BT OL (0 to 255 displayed)	Overcurrent in the power supply to BT Module is detected. The assumption is a failure in Module. XERR_BT (Main/IC1504-Y14 pin) "L" detection	1) Mute On 2) Error display at GUI 3) Transit POW_BT (IC1504-W14 pin) to Low, and the keys other than the Standby/On key become invalid.	Power OFF → Power ON effects a return.	In the event of UART communication error with the BT module, BT error 5 is displayed.
WiFi Module Over Current Detection	Error 8	-	USB W ERR (0 to 255 displayed)	Overcurrent in the power supply to WiFi Module (Wireless LAN Converter) is detected. The assumption is a failure in Module. XERR_USB_W (Sub/IC1001-3 pin) "L" detection	1) Transit POW_USB_W (IC1001-6 pin) to Low. 2) Error is displayed at GUI (not confirmed when the detection is startup Standby), and the keys other than the Standby/On key become invalid.	Power OFF → Power ON effects a return.	Since POW_USB_W remains in High to turn ON the power by ControlApp, the detection continues even after the transition to the high-speed startup Standby. When the detection is confirmed during the high-speed startup Standby, transit POW_USB_W to Low. After that, when the power is turned ON, POW_USB_W is set to High and after a lapse of 10 ms, the detection starts again.
Front USB Over Current Detection	USB overcurrent Error 7	-	USB (0 to 255 displayed)	Overcurrent in the power supply to Front USB (iPod/iPhone/iPad/USB memory) is detected. The assumption is a failure in Module. XERR_USB_F (Main/IC1504-D2 pin) "L" detection	1) Transit POW_USB_F (IC1001-22 pin) to Low. 2) Error is displayed at GUI, and the keys other than the Standby/On key become invalid.	Power OFF → Power ON effects a return.	
Front USB Over Voltage Detection	-	Standby LED	-	Overcurrent in the power supply to Front USB (iPod/iPhone/iPad/USB memory) is detected. The assumption is a failure in DCDC Converter. XDDCERR_USB_F (Sub/IC1001-40 pin) "L" detection	Immediately shut down.	Not returnable Only releasing method described below	This protection operation is intended for protection of the external connection equipment against a failure within the body. The device is put in the unreturnable state in the event of an error.

### [Releasing method for the power ON disabled state]

Input "ESC(A85F)" → "TEST(A85E)" on the service remote controller (GGF1381).

### 5.3 HOW TO CHECK THE IC COMMUNICATION

The Major IC (MainCPU, SubCPU, DSP, DIR, DAC, etc.) communications checking method

A

The communications status with each LSI can be checked as follows:

■ Communications of MainCPU ↔ SubCPU

In about one minute after the Power ON, the function screen appears. If the display is switched by change-over of functions, there is no problem in the communications.

■ Communications of SubCPU ↔ DSP (N-50, N-50-K/-S only)

In the event of DSP communications error, "Error 9" is displayed on the LCD. If "Error 9" is not displayed, the communications have been established.

■ Communications of SubCPU ↔ DIR

Select DigitalIn1, and when the sound input to DigitalIn1 is output from Opt or Coax, the communications have been established.

B

### 5.4 IC INFORMATION

## J040-22601-001-0S (POWER SWITCH)

Block Diagram

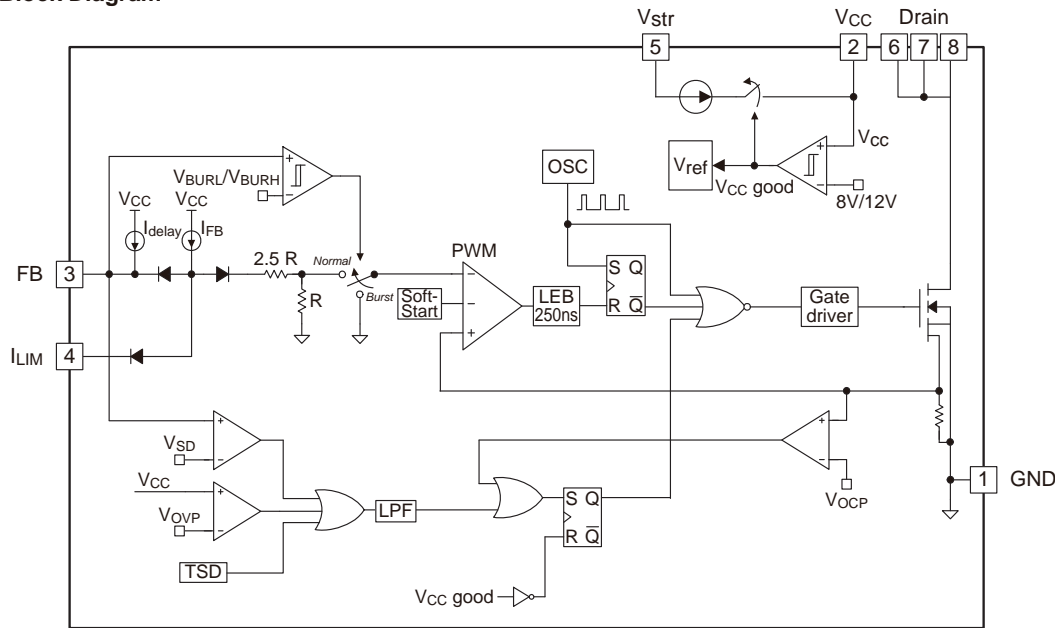

Pin Layout

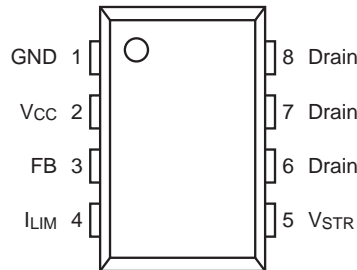

Pin Definitions

Pin No.	Pin Name	Description
1	GND	Ground
2	Vcc	Power Supply
3	FB	Feedback
4	ILIM	Peak Current Limit
5	VSTR	Startup
6,7,8	Drain	SenseFET Drain

C

D

E

F



## 6. SERVICE MODE

### 6.1 SERVICE MODE

#### 1. Service Mode

When the device is put in the Service Mode, the dedicated menu starts up.  
As long as the menu is open, the Service Mode is in operation.  
The items implemented by the menu are as follows:

- Check of Versions for MainCPU / SubCPU / DSP
- Check of Model Information (For which is SubCPU in operation, N-30(N-30-K/-S) or N-50(N-50-K/-S)?)
- Check of Network Information
- Update of USB for MainCPU / SubCPU
- Check of the number of protection circuit detections and clear
- Factory Setting

In the Service Mode, the protection circuit detection operates in the same way as during in the normal operation.

#### 2. How to enter the Service Mode

Enter "ESC(A85F)" → "+10(A81F)" on the service remote controller GGF1381 while the power of the Main Unit is ON, and the menu for the Service Mode starts up.

- \* If any input from another remote controller is made between "ESC" and "+10", the Service Mode is not entered.  
The entry status of the "ESC" key is cleared at the time of Power OFF.

#### 3. How to leave the Service Mode

When the menu is left, the Service Mode exits.  
The menu is left by switching of functions, Power OFF or the return key input on the top-end layer of the menu.

#### 4. Menu

The operation of the menu shall be conducted with the cursor keys of the product's remote controller.  
Use the Enter key for selection of an item and use the Return key for return of one layer.  
The top menu is as shown in the screen below.

[Display Screen]

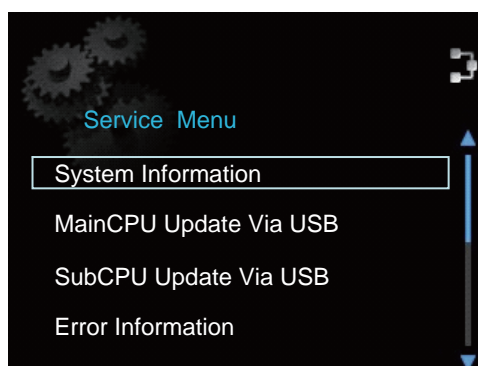

In addition, menu operation by the Main Unit button is also capable if attached remote controller is not available.  
In that case, perform the following actions;

- ►►► : ↓
- ◀◀◀ : ↑
- ►/|| : Enter
- ■ : Return

In some menu, it is unable to return to one hierarchy layer before with the [■] button. In that case, please exit from the Service Mode once with function button, etc.

### 4-1. System Information

When the System Information is selected, the screen below is displayed.

[Display screen]

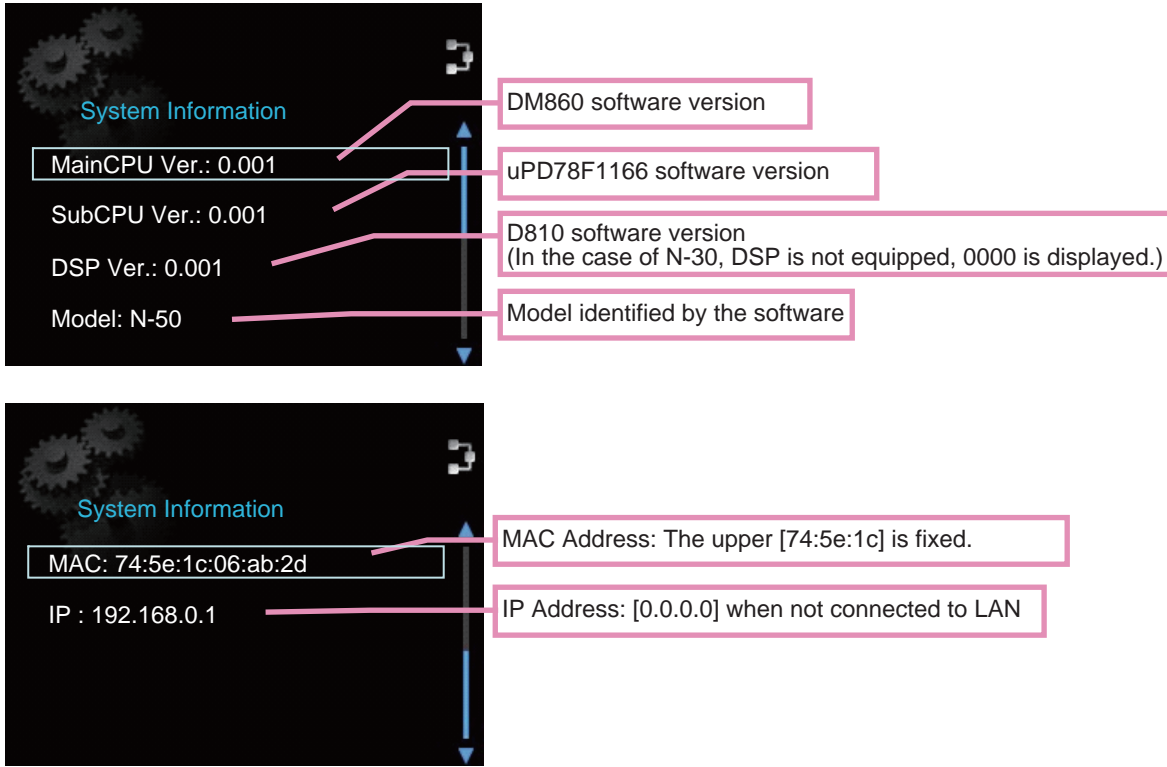

### 4-2. MainCPU Update Via USB

See the "8.1 FIRMWARE UPDATE".

### 4-3. SubCPU Update Via USB

See the "8.1 FIRMWARE UPDATE".

### 4-4. Error display for protection circuit, etc.

When "Error Information" is selected on the ServiceMenu, the screen below is displayed.

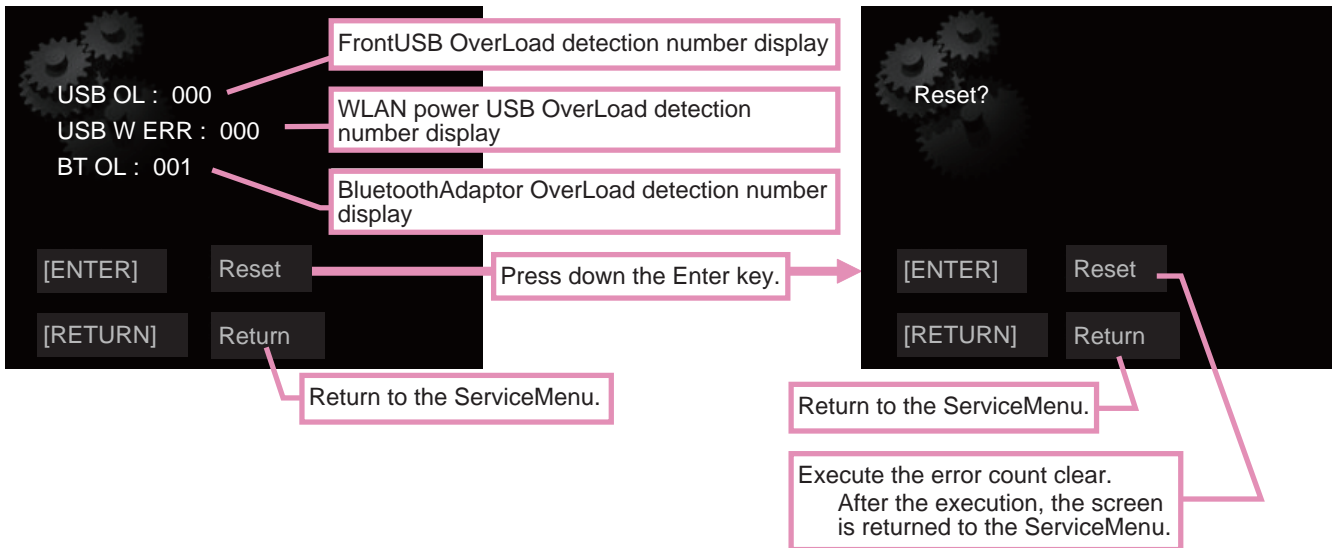

## 5. Factory Setting

When the "Factory Reset" is selected on the ServiceMenu, the screen below is displayed.

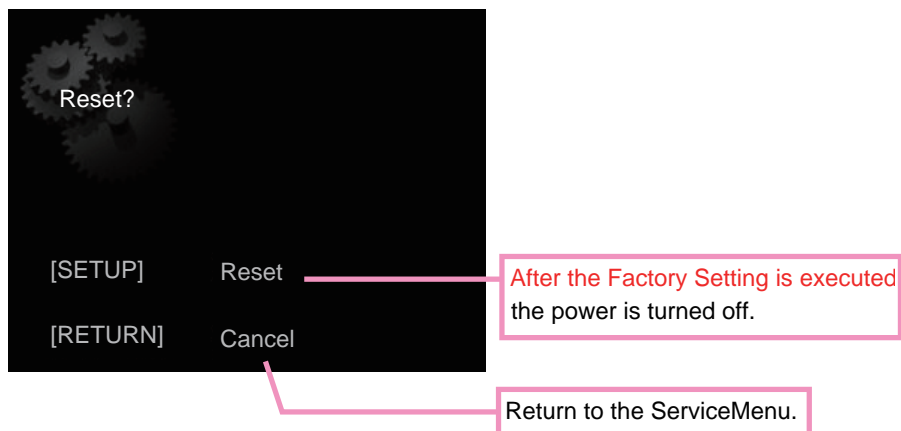

## 6.2 INITIAL SETTING

	Setting name	Initial value	Setting range
SETUP system	Intensity setting	LEVEL3	LEVEL3 / LEVEL2 /LEVEL1
	Display OFF setting	Continuous display	Display OFF/Continuous display
	Automatic Power Off	ON	ON/OFF
	High-Speed startup mode	OFF	ON/OFF
	Language setting	English	English, French, German, Dutch, Italian, Spanish, Russian, Japanese
SOUND system	AutoSoundRetriever	OFF	ON/OFF
	AutoLevelControl	OFF	ON/OFF
	SoundRetriverAir	OFF	ON/OFF
	Hi-bit32	OFF	ON/OFF
	PureAudio	OFF	ON/OFF
SYSTEM	FUNCTION	iPod	All functions
NETWORK	DHCP	ON	ON/OFF
	IP Address	0.0.0.0	0.0.0.0 ~ ff.ff.ff.ff
	SubNetmask	0.0.0.0	0.0.0.0 ~ ff.ff.ff.ff
	Gateway	0.0.0.0	0.0.0.0 ~ ff.ff.ff.ff
	DNS 1	0.0.0.0	0.0.0.0 ~ ff.ff.ff.ff
	DNS 2	0.0.0.0	0.0.0.0 ~ ff.ff.ff.ff
	Proxy setting	Don't Use	Don't Use/Use
	Proxy server	(Null)	128 characters
	Proxy port	(Null)	0 ~ ffff
	Favorite	0 station	20 station
	Parental lock setting	OFF	ON/OFF
	Parental lock password	0000	0000 ~ 9999
	Friendly Name	*1	
BT	PIN CODE	0000	0000 / 1234 / 8888

When the power cord is plugged off or the power is turned off by the STANDBY/ON switch of the Main Unit, the saving of the above setting values is not ensured.

The display OFF setting becomes valid till the power is turned off.

The function that was finally selected is saved at the time of transition to STANDBY. It cannot be saved by the STANDBY/ON switch of the Main Unit.

\*1: The Model Name shall be the initial value.

"N-50" for the upper model, and "N-30" for the lower model.

\*2: When the power is turned off by the STANDBY/ON switch of the Main Unit during the saving of settings in progress, the saving of the setting values is not ensured.

# 7. DISASSEMBLY

**Note 1 :** Even if the unit shown in the photos and illustrations in this manual may differ from your product, the procedures described here are common.

**Note 2 :** As for the assembling, please perform assembling following to the opposite procedures of How to Disassemble. If any notes are existed, please follow those instructions.

## [1] Cabinet

- (1) Remove the four screws.  
( N-50/CUXE, N-50-K/SYXE8 )  
( N-30/CUXE, N-30-K/SYXE8: )  
1500040083B10-IL
- ( N-50-S/SYXE8, N-30-S/SYXE8: )  
1500040084B10-IL
- (2) Remove the five screws.  
(BBZ30P060FTB)

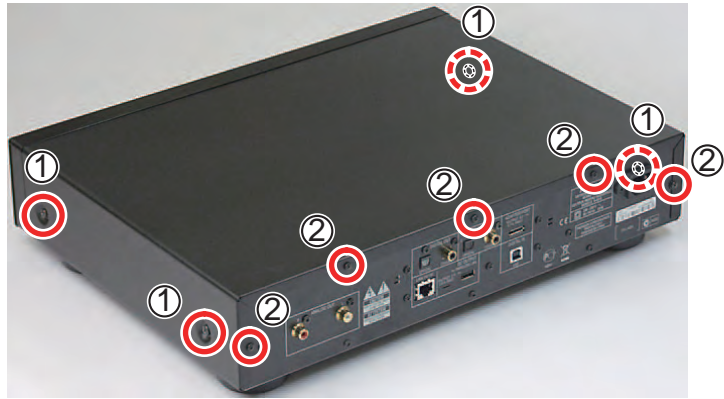

- (3) Insert nails between the Cabinet and Back Chassis and pull the Cabinet backward horizontally.

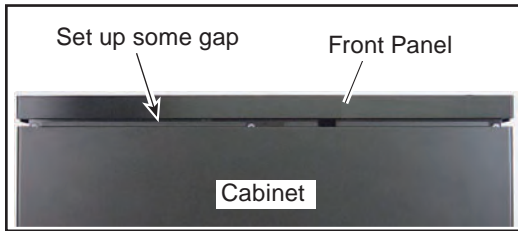

- (4) Take out Cabinet upward while spreading Rear Side Piece.

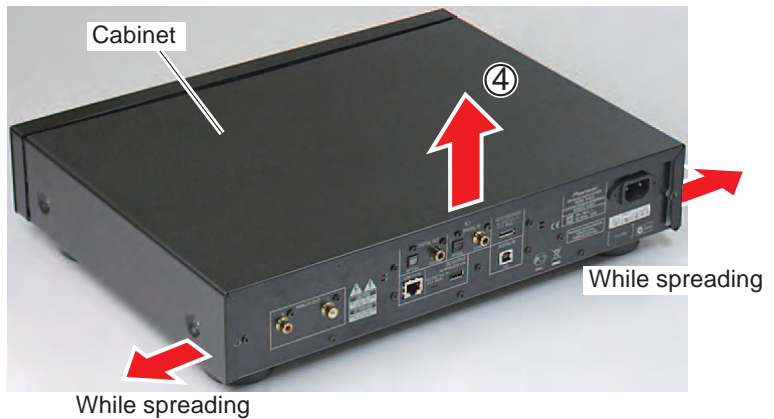

## [2] Front Section

- (1) Remove the five screws.  
 ( N-50/CUXE, N-50-K/SYXE8 )  
 ( N-30/CUXE, N-30-K/SYXE8: )  
 BBZ30P080FTB  
 ( N-50-S/SYXE8, N-30-S/SYXE8: )  
 BBZ30P080FNI



- (2) Remove the two screws. (BBZ30P080FTC)  
 (3) Remove the screw. (B020230063B10-IL)  
 (4) Cut the Binder. (N-50, N-50-K/-S)  
 (5) Release the cables from the PCB Binder.  
 (N-50, N-50-K/-S)

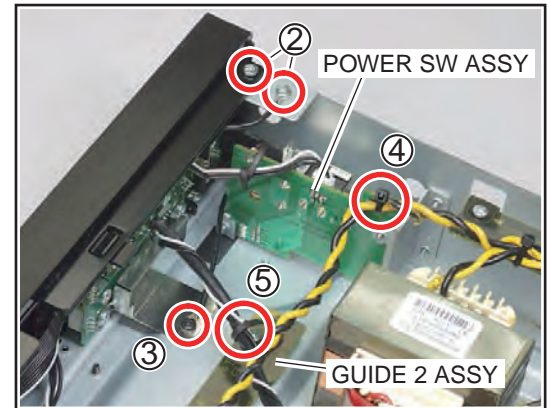

- (6) Release the cables from the Binder.  
 (N-50, N-50-K/-S)

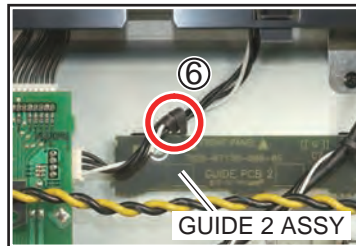

- (7) Release the cables from the PCB Binder.  
 (8) Remove the screw.  
 (BBZ30P080FTC)

- (9) Loosen the screw. (BBZ30P080FTC)

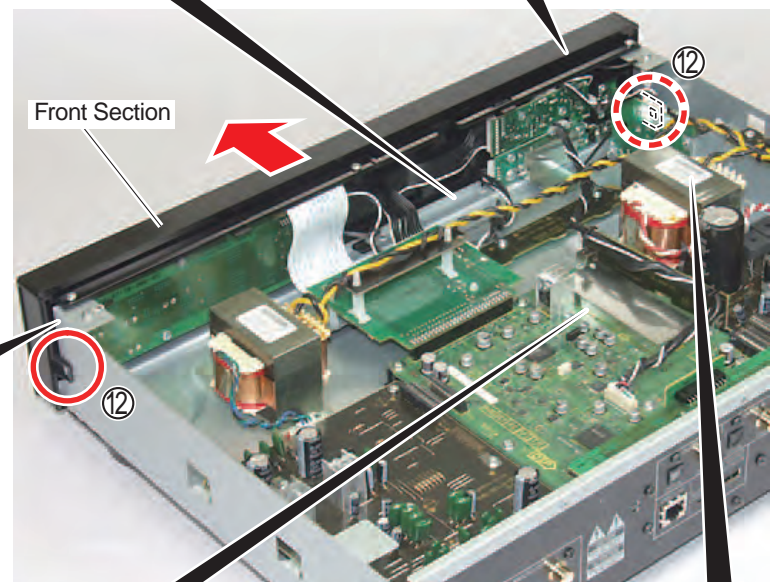

- (10) Cut the two Binders.

- (11) Insert a Screwdriver through the holes at left side of the Main Chassis and remove the three screws. (BBZ30P060FTC)

- (12) Unhook the two hooks and remove the Front Section.

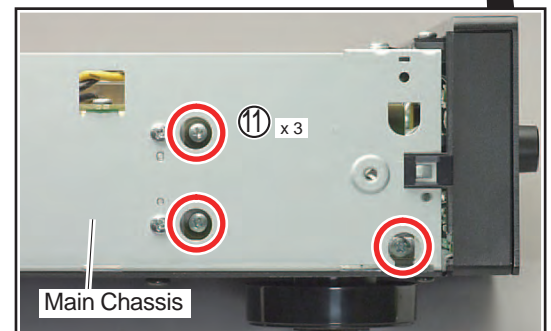
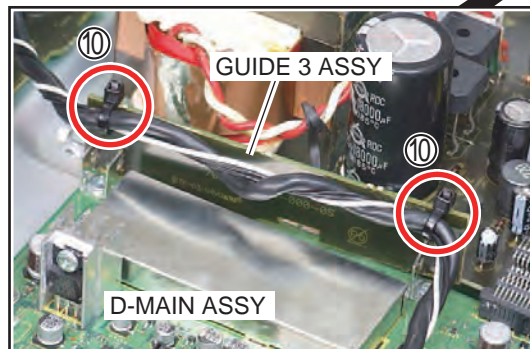
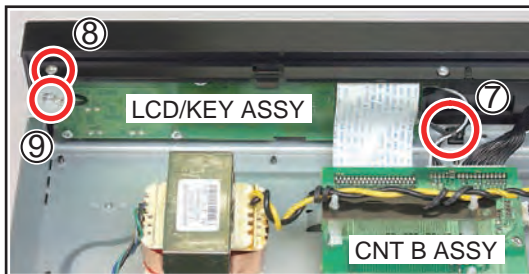

### [3] Diagnosis

- (1) Attach a Ground Cable from the IR ASSY with the screw. (B020230063B10-IL)
- (2) Attach a Ground Cable from the LED ASSY with the screw. (BBZ30P080FTC)  
Please use the screw hole near front to detach the Front Part.

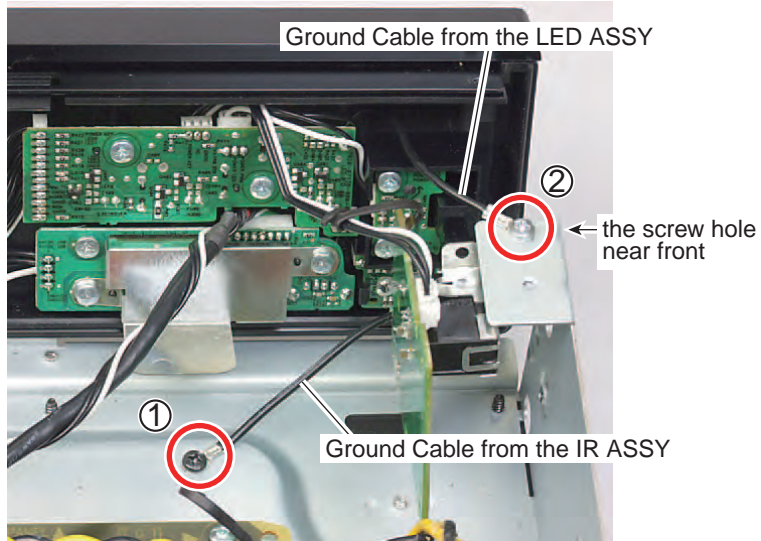

- (3) Arrange the units as shown in the photo.



- (4) Connect the Shield on USB ASSY to the Main Chassis Ground.

**Note:** Make the USB ASSY, IR ASSY not to touch with the Main Chassis for avoiding short circuited.

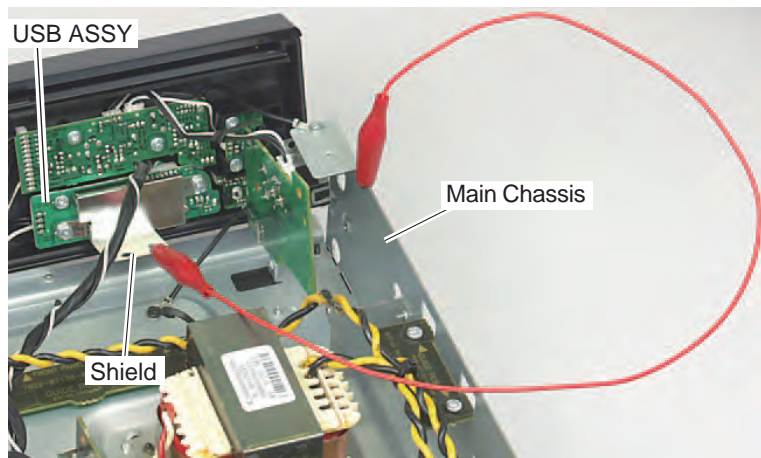
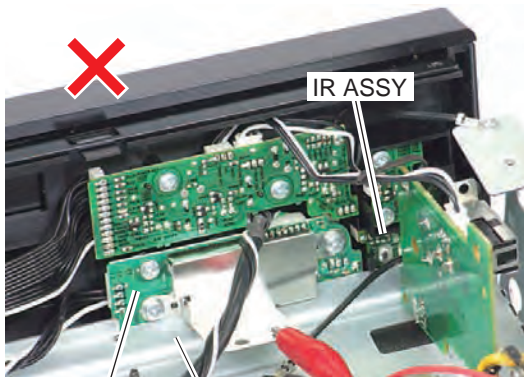

USB ASSY  
Main Chassis

## Notes on assembling

### [1] Styling of cables

- (1) FFC between the LCD/KEY ASSY and CNT B ASSY

Make FFC not to touch with the LCD/KEY ASSY by folding the base of auxiliary plate located at the CNT B ASSY at a right angle.

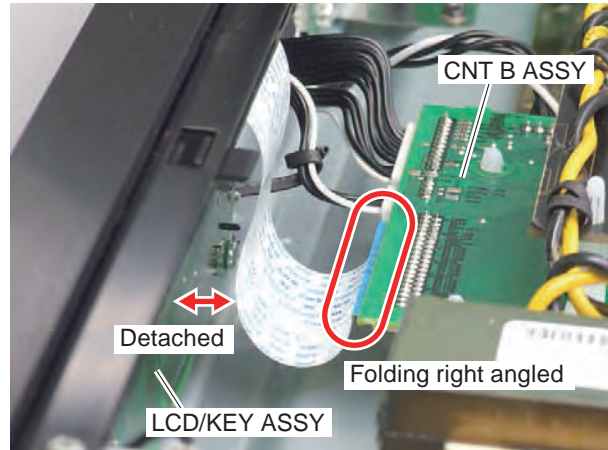

- (2) Secondary Side Cable of the Power Trans  
(N-50/CUXE: 8200570300120-IL)  
(N-50-K/SYXE8, N-50-S/SYXE8: )  
8200570300130-IL

Put down the Cable not to touch with the Cabinet.

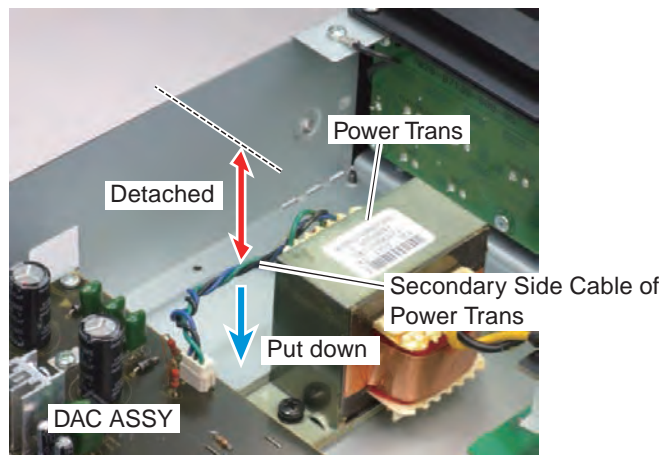

- (3) Primary Side Cable of the Power Trans  
(N-50/CUXE: 8200570300120-IL)  
(N-50-K/SYXE8, N-50-S/SYXE8: )  
8200570300130-IL

Make some Cable extra length by pulling the Cable lightly toward the Power Trans side not to touch with the Cabinet after fixing the Cable with the PCB Binder of POWER SW ASSY.

Securely fix the Cable with insulated the PCB Binder of GUIDE 4 ASSY not to touch with the Cabinet.

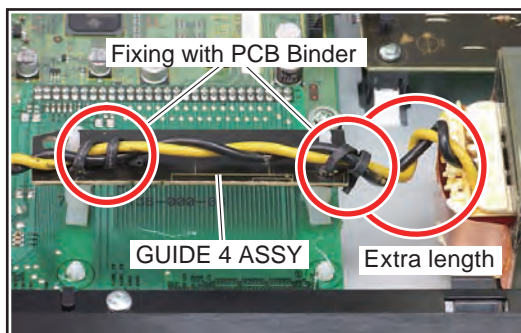

[Case of N-30, N-30-K/-S] →

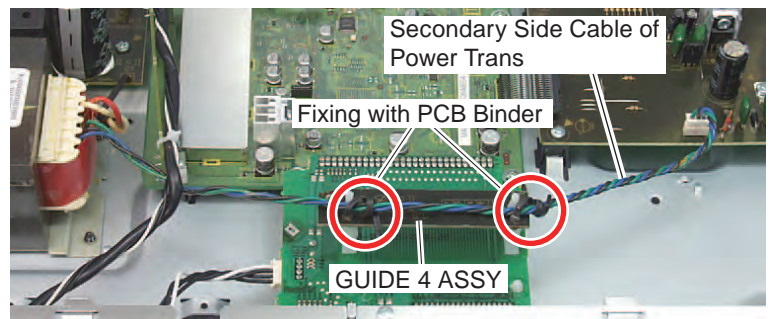
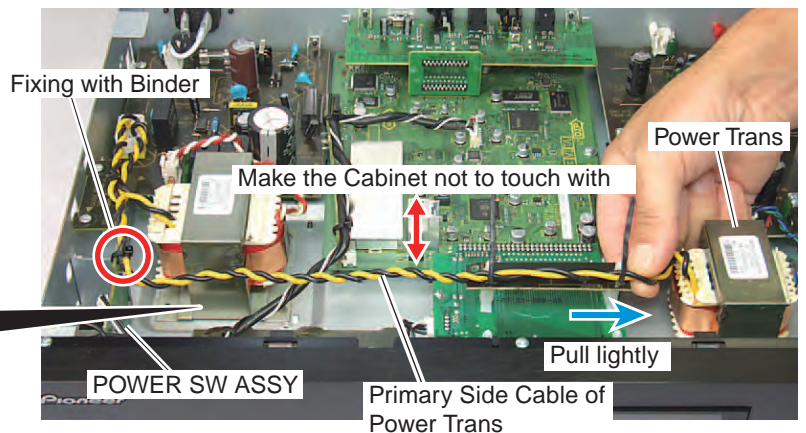

- (4) Secondary Side Cable of the Power Trans (N-50/CUXE: 8200660300120-IL) (N-50-K/SYXE8, N-50-S/SYXE8: 8200660300130-IL) (N-30/CUXE: 8200660300150-IL) (N-30-K/SYXE8, N-30-S/SYXE8: 8200660300160-IL)

Fix the Secondary Side Cable of Power Trans with the PCB Binder of STBY ASSY not to touch with the Cable from USB ASSY.

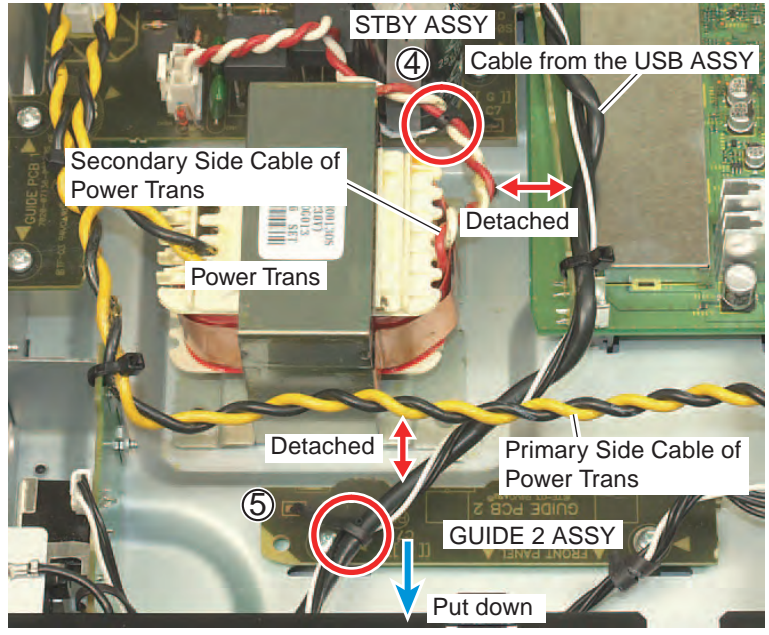

Front

- (5) Cable from the USB ASSY
- Fix the Cable from the USB ASSY with the PCB Binder of GUIDE 2 ASSY not to touch with the Primary Side Cable of Power Trans. (N-50/CUXE: 8200570300120-IL) (N-50-K/SYXE8, N-50-S/SYXE8: 8200570300130-IL)

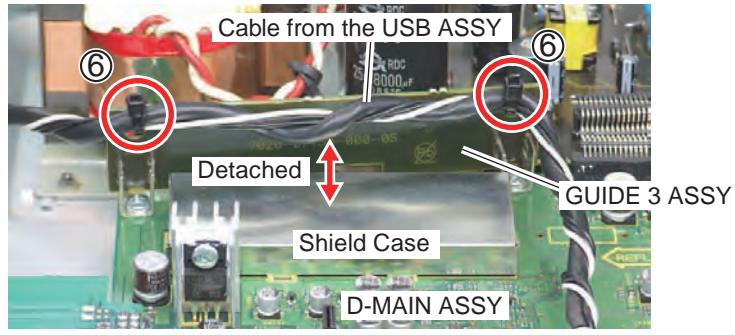

Front

- (6) Cable from the USB ASSY
- Fix the Cable to the GUIDE 3 ASSY without sag with the two Binders not to touch the Shield Case of D-MAIN ASSY.

- (7) 4P Connector ASSY from the LCD/KEY ASSY
- Fix the Cable at center with the PCB Binder of LCD/KEY ASSY not to touch with the 12P Connector ASSY from FFC and LED ASSY.

LCD/KEY ASSY

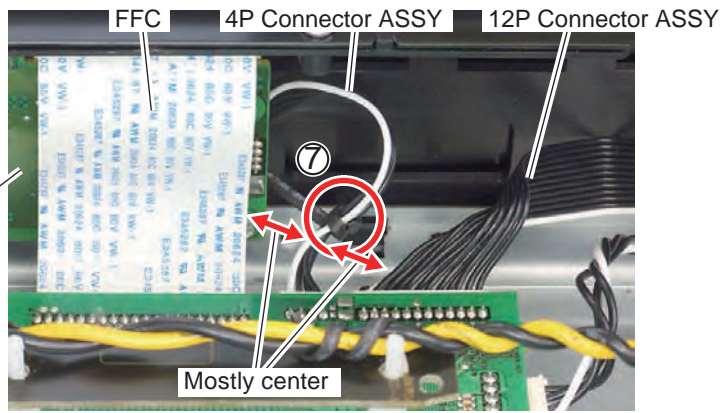

Front

- (8) 12P connector ASSY
- Perform the styling of the Cable along the line with the Panel Frame (approximate the Cable to the Panel Frame as possible).

- (9) 4P Connector ASSY from the USB ASSY
- Put down the Cable apart from the Primary Side Cable of Power Trans and fix it with the Binder. However, the Cable from the USB ASSY should not to touch with the screw of Binder as well as the Main Chassis.

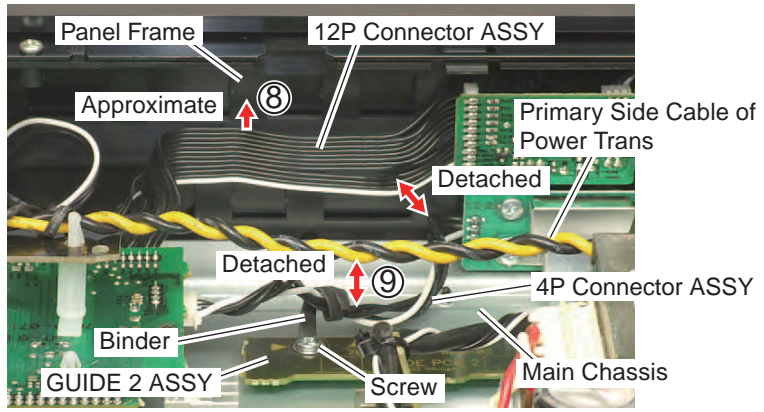

Front



(10) 3P Connector ASSY from the LED ASSY  
Fix with the PCB Binder of POWER SW ASSY by lowering the 3P Connector ASSY not to touch with the Cabinet.

(11) Primary Side Cable of the Power Trans  
(N-50/CUXE : 8200660300120-IL )  
                  : 8200570300120-IL )  
(N-50-K/SYXE8, N-50-S/SYXE8  
                  : 8200660300130-IL )  
                  : 8200570300130-IL )  
(N-30/CUXE : 8200660300150-IL )  
(N-30-K/SYXE8, N-30-S/SYXE8  
                  : 8200660300160-IL )

Fix the Cable on GUIDE 1 ASSY with the Binder not to touch with the Main Chassis Side Piece and the Screw Heads.

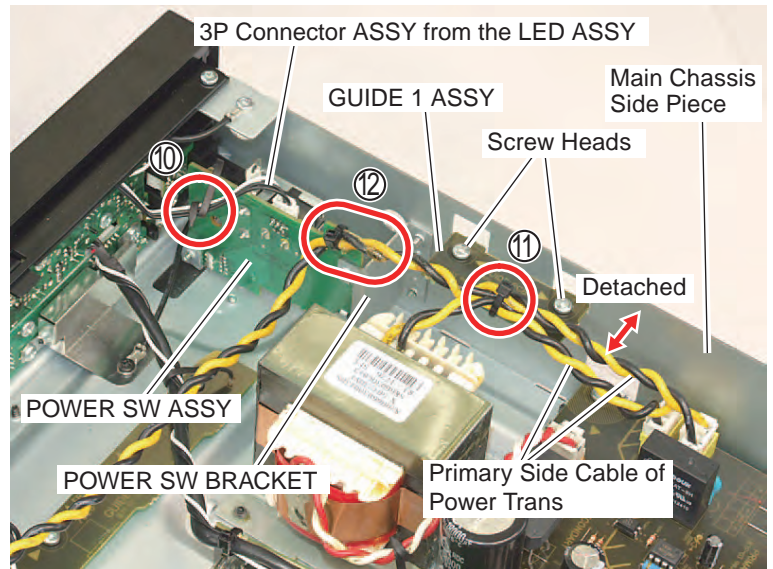

(12) Primary Side Cable of the Power Trans  
(N-50/CUXE : 8200570300120-IL )  
(N-50-K/SYXE8, N-50-S/SYXE8  
                  : 8200570300130-IL )

Fix the Cable on POWER SW ASSY with the Binder not to touch with the edge of POWER SW BRACKET.

[Case of N-50, N-50-K/-S]

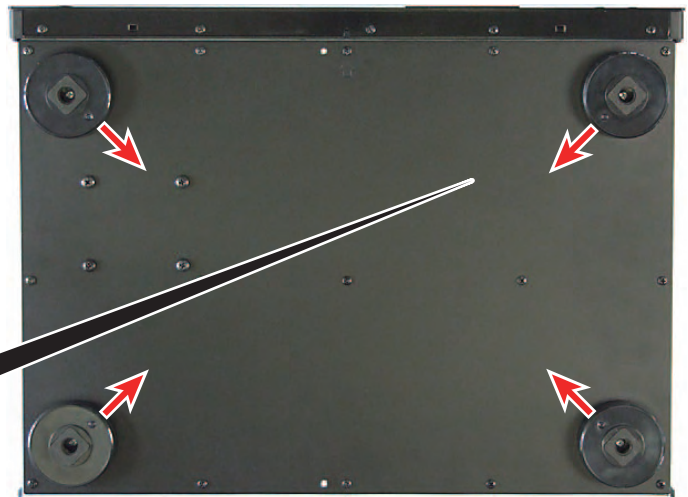

## [2] Direction of Insulator

Align the mark at under surface of Insulator with the direction of photo.

(N-50/CUXE, N-50-K/SYXE8 )  
(N-30/CUXE, N-30-K/SYXE8:  
4000210391000-IL

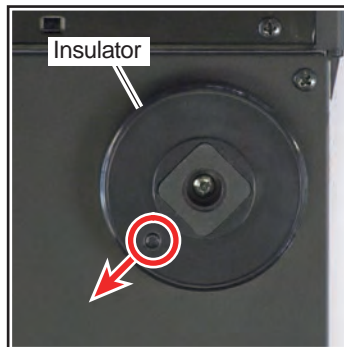

(N-50-S/SYXE8, N-30-S/SYXE8:  
4007210391000-IL

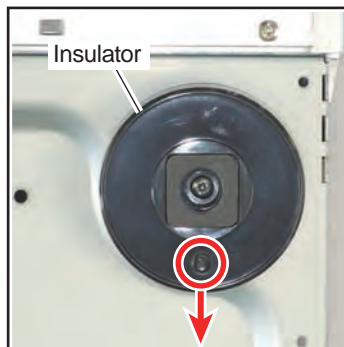

[Case of N-30, N-30-K/-S]

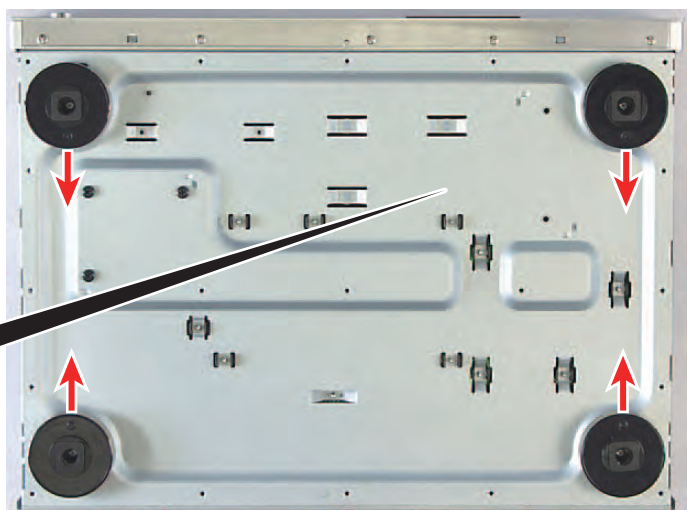



# 8. EACH SETTING AND ADJUSTMENT



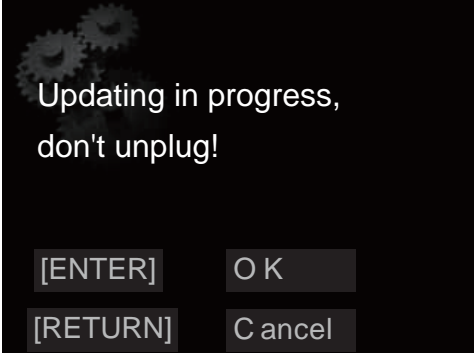

## 8.1 FIRMWARE UPDATE

- A 1. Save the update files for MAIN CPU (NAP12Main\_\*\*\*.bcd) and for SUB CPU (NAP12Sub\_\*\*\*.bcd) in the root folder of the USB Memory.
  - \* Do not put two or more update files in the root folder.
  - Only one update file that is first found is recognized.
2. Plug the power cord into the receptacle and turn on the power.
3. Connect the USB Memory in which the update file has been stored to the Main Unit.
4. Press "ESC" ⇒ "+10" from service remote controller GGF1381 and enter into the Service Mode.
5. Select "MainCPU Update via USB" or "SubCPU Update via USB" on the Menu Screen.
6. Press on the "ENTER" key on the Update Screen, and the update starts.
7. To update the Main CPU, DM860 automatically restarts and the software writing processing automatically starts up.
  - When the update is successfully completed, the progress bar turns green and the restart automatically operates.
- B 8. To update the Sub u-com, the Update of uPD78F1166 starts and the LED for the Main Unit flashes during the update processing.
  - When the update is completed, the LED flashing stops, the LCD blacks out and the Main Unit goes into standby.
9. By "System Information" of "6.1 SERVICE MODE" menu, confirm that Main Ver and Sub Ver have been updated.

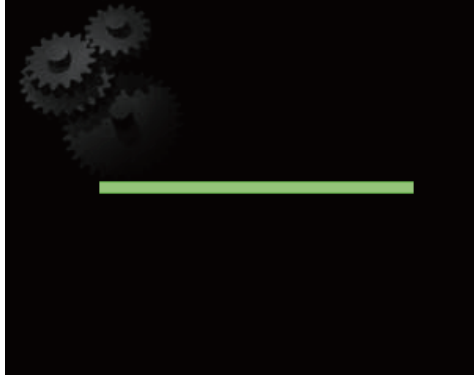

Note: Do not plug off the power cord during the update processing.

### MAIN CPU Update Screen

Explanation	Key operation	FL display	Time
<p>When "Update" is selected from the menu, this screen appears.</p> <p>On this screen, press the [ENTER], and the update starts.</p> <p>[RETURN]: Returns to an immediately preceding screen.</p> <p>For the error display after the [ENTER] key is pressed, see *1 in the detailed description.</p>	<p>[ENTER] [RETURN]</p>		
<p>DM860 automatically restarts.</p>	<p>Key invalid</p>		<p>About 20 seconds</p>

Explanation	Key operation	FL display	Time
<p>When the restart of DM860 is completed, the background is displayed for about 20 seconds.</p>	Key invalid		About 20 seconds
<p>After the restart, the software writing processing automatically starts up.</p> <p>The status of writing is displayed by the progress bar.</p>	Key invalid		
<p>When the update is successfully completed, the progress bar turns green and the restart automatically operates.</p>	Key invalid		
<p>When the download fails, the progress bar turns red.</p> <p>In the case of failure, this state is continued. Plug off and on the power cord to return to a normal state.</p> <p>The previous version starts up.</p> <p>In the case of a failure in data, the progress bar turns red.</p>			

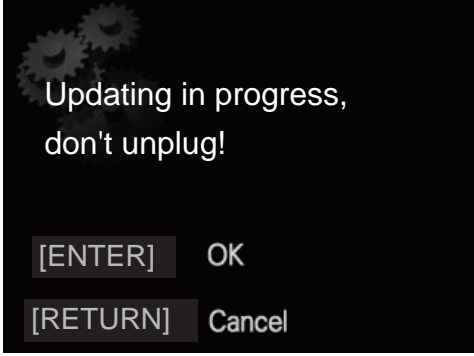
### State of the Sub CPU Update Screen

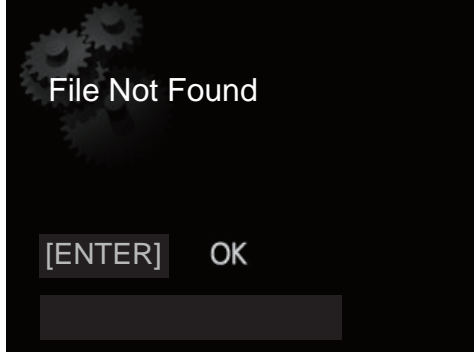
Explanation	Key operation	FL display	Time
<p>A</p> <p>On this screen, press the [ENTER], and the update starts.</p> <p>[RETURN]: Returns to an immediately preceding screen.</p> <p>B For the error display after the [ENTER] key is pressed, see *1 in the detailed description.</p>	<p>[ENTER] [RETURN]</p>		
<p>C</p> <p>Update of uPD78F1166 starts and "Updating in progress" is displayed.</p> <p>The blue LED flashes during the updating processing.</p>	<p>Key invalid</p>		<p>About 5 minutes</p>
<p>D</p> <p>When the update is completed, the LCD blacks out and the Main Unit goes into a standby state.</p>			
<p>E</p> <p>If no update file exists in USB, the warning is displayed.</p> <p>Press [Enter] to return to the menu and re-do.</p> <p>* If the USB Memory is not inserted, the warning is displayed.</p> <p>F</p>			

## 8.2 HOW TO CHECK EACH TERMINAL

### 1. Check of LAN terminal

Directly connect PC and this device and conduct the setting below. Then, access to the set by Web Browser of PC.  
If the display as shown below appears, the LAN Terminal is in the normal state.

#### Setting for this device:

1. Turn the power ON.
2. Press "SETUP" and select Network Setting → Connection Setting → DHCP OFF.
3. Set as follows
 

IP Address	: 192.168.0.1
Subnet Mask	: 255.255.255.0
Gateway Address	: 0.0.0.0
NDS (1st)	: 0.0.0.0
NDS (2nd)	: 0.0.0.0
Proxy Setting	: Not used
4. After the setting, press "RETURN" to leave the menu.

#### Setting for PC:

1. Press the "Start" button, "Setting" → open "Control Panel".
2. Open "Network Connection", double click "Local Area Connection", and open the Local Area Connection status.
3. Press the "Property" button and open the Local Area Connection property.
4. Double click the Internet Protocol.

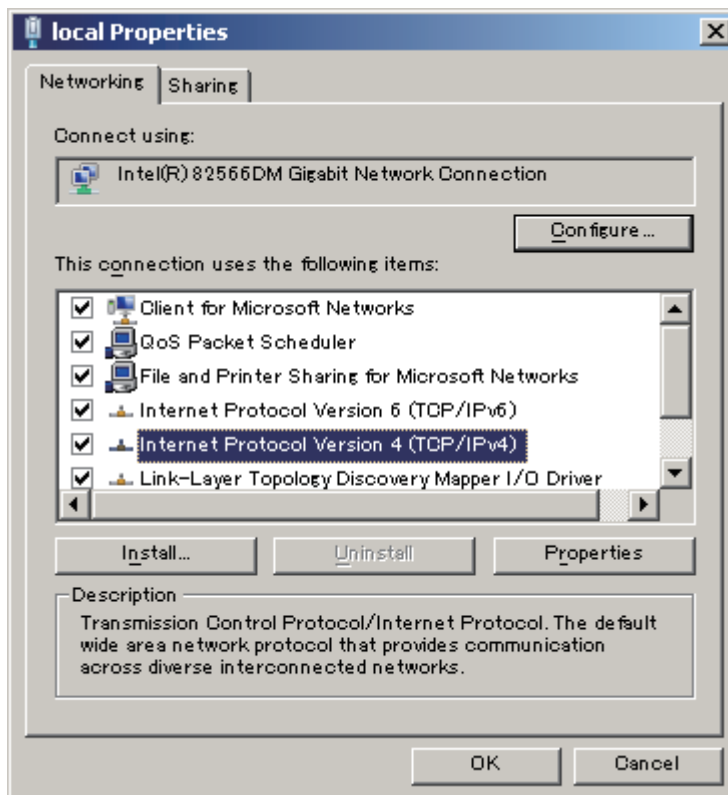

5. Set as shown below.

A

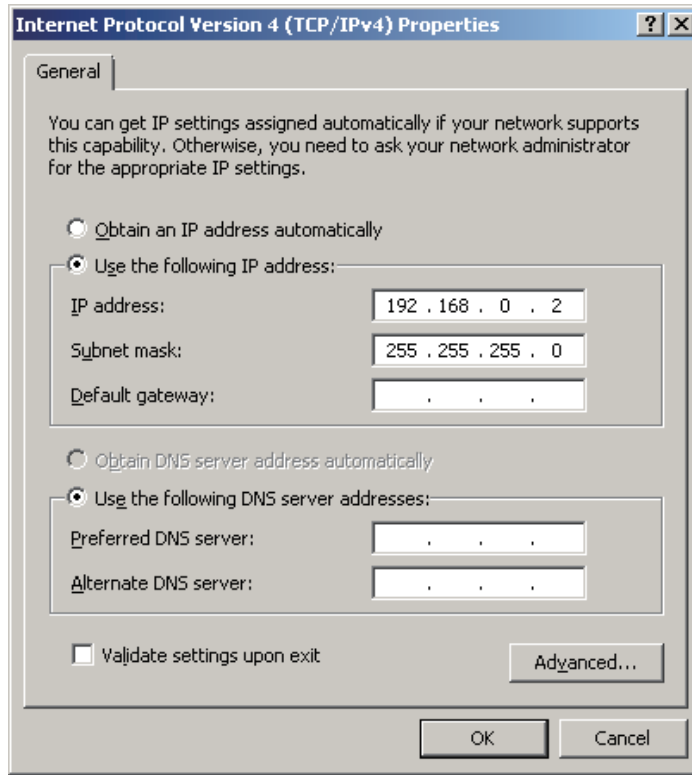

B

C

Start the Web Browser and enter http://192.168.0.1 for URL. When the screen as shown below appears, the terminal is in the normal state.

D

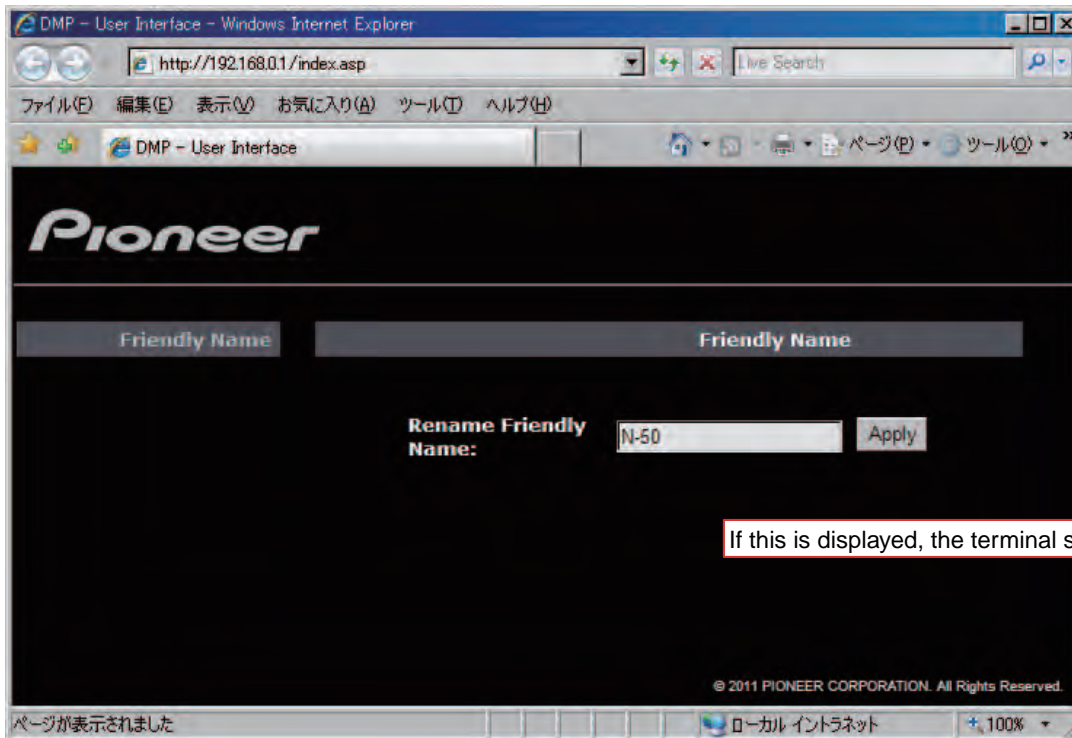

E

## 2. USB-B (Rear)

Turn ON the Main Unit and connect to PC with a USB-B cable.

Install the driver downloaded on Pioneer's home page. When Pioneer USB Audio Device is displayed for the item of "Sound, Video and Game Controller" of the Device Manager of PC, the terminal state is normal.

F

■

5

■

6

■

7

■

8

■

A

■

B

■

C

■

D

■

E

■

F

■

5

■

6

N-50

■

7

■

8

■

# 9. EXPLODED VIEWS AND PARTS LIST

- NOTES:
- Parts marked by "NSP" are generally unavailable because they are not in our Master Spare Parts List.
  - The  $\triangle$  mark found on some component parts indicates the importance of the safety factor of the part. Therefore, when replacing, be sure to use parts of identical designation.
  - Screws adjacent to  $\nabla$  mark on product are used for disassembly.
  - For the applying amount of lubricants or glue, follow the instructions in this manual. (In the case of no amount instructions, apply as you think it appropriate.)

## 9.1 PACKING SECTION

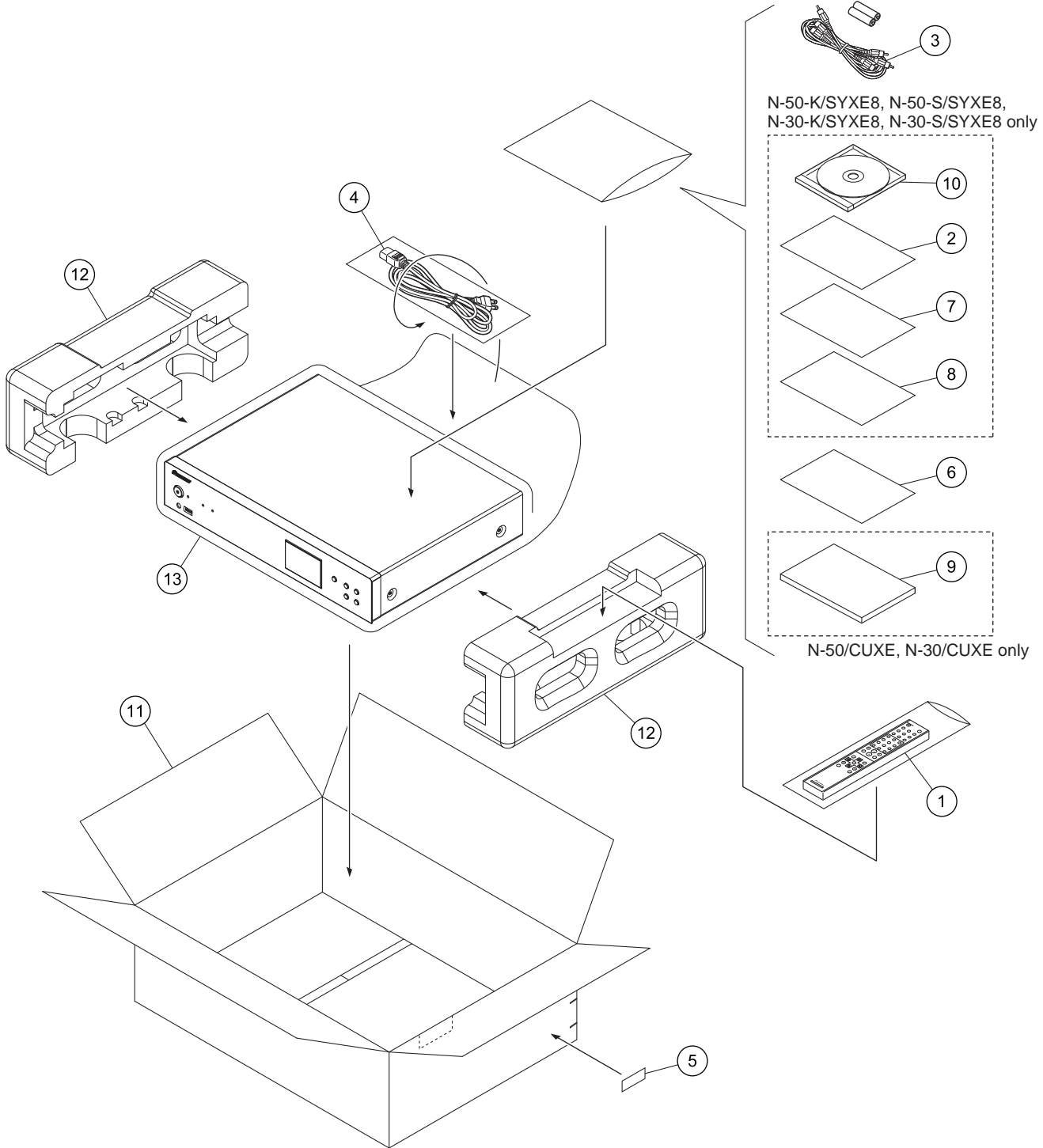



**(1) PACKING SECTION PARTS LIST**

<b>Mark No.</b>	<b>Description</b>	<b>Part No.</b>
	1 Remote Control Unit (AXD7641)	8300764100010-IL
NSP	2 Warranty Card	See Contrast table (2)
	3 Audio Cable	L063102020050-IL
⚠	4 AC Power Cord	See Contrast table (2)
NSP	5 Serial Label	RRW-168
	6 Caution Sheet	See Contrast table (2)
	7 Safety Sheet	See Contrast table (2)
	8 Quick Guide	See Contrast table (2)
	9 Operating Instructions (En, Fr)	See Contrast table (2)
	10 Operating Instructions (CD-ROM) (En,Fr,De,It,Es,NI,Ru)	See Contrast table (2)
	11 Packing Case	See Contrast table (2)
	12 Pad L/R	6230213084000-IL
	13 PE, Sheet	6327040059000-IL

**(2) CONTRAST TABLE**

N-50/CUXE, N-50-K/-SYXE8, N-50-S/SYXE8, N-30/CUXE, N-30-K/-SYXE8 and N-30-S/SYXE8 are constructed the same except for the following:

<b>Mark</b>	<b>No.</b>	<b>Symbol and Description</b>	<b>N-50/CUXE</b>	<b>N-50-K/-SYXE8</b>	<b>N-50-S/SYXE8</b>	<b>N-30/CUXE</b>	<b>N-30-K/-SYXE8</b>	<b>N-30-S/SYXE8</b>
NSP	2	Warranty Card (*1)	Not used	ARY7128	ARY7128	Not used	ARY7128	ARY7128
⚠	4	AC Power Cord	L068125130010-IL	L068250160020-IL	L068250160020-IL	L068125130010-IL	L068250160020-IL	L068250160020-IL
	6	Caution Sheet	5227000002270-IL	5227000002280-IL	5227000002280-IL	5227000002270-IL	5227000002280-IL	5227000002280-IL
	7	Safety Sheet	Not used	5227000002330-IL	5227000002330-IL	Not used	5227000002330-IL	5227000002330-IL
	8	Quick Guide	Not used	5707000006140-IL	5707000006140-IL	Not used	5707000006140-IL	5707000006140-IL
	9	Operating Instructions (En, Fr)	5707000006130-IL	Not used	Not used	5707000006130-IL	Not used	Not used
	10	Operating Instructions (CD-ROM) (En,Fr,De,It,Es,NI,Ru)	Not used	651700000450-IL	651700000450-IL	Not used	651700000450-IL	651700000450-IL
	11	Packing Case	6007212010060-IL	6007212010050-IL	6007212010080-IL	6007212010010-IL	6007212010020-IL	6007212010070-IL

(\*1) : The Warranty card of CUXE models are included in the operating instructions.

# 9.2 EXTERIOR SECTION

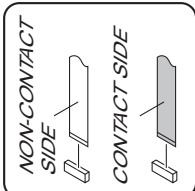
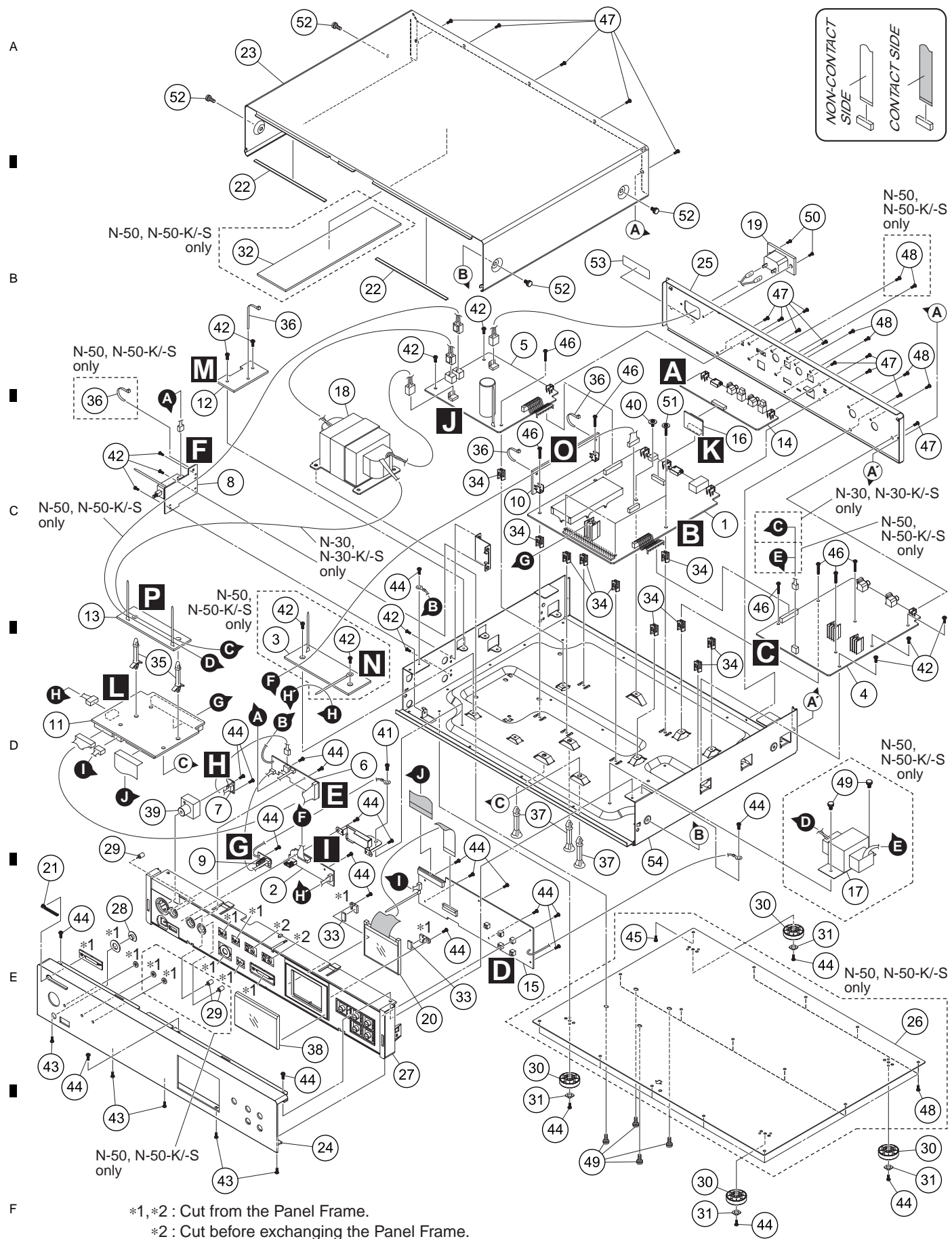

N-50, N-50-K/-S only

N-50, N-50-K/-S only

N-50, N-50-K/-S only

N-50, N-50-K/-S only

N-30, N-30-K/-S only

N-50, N-50-K/-S only

N-30, N-30-K/-S only  
N-50, N-50-K/-S only

N-50, N-50-K/-S only

N-50, N-50-K/-S only

N-50, N-50-K/-S only

\*1, \*2 : Cut from the Panel Frame.  
\*2 : Cut before exchanging the Panel Frame.

**(1) EXTERIOR SECTION PARTS LIST**

Mark No.	Description	Part No.	Mark No.	Description	Part No.
1	D-MAIN ASSY	See Contrast table (2)	26	Bottom Chassis	See Contrast table (2)
2	USB ASSY	7028071371010-IL	27	Panel Frame	See Contrast table (2)
3	GUIDE 2 ASSY	See Contrast table (2)	28	Lens (Remocon)	See Contrast table (2)
4	DAC ASSY	See Contrast table (2)	29	Lens (Standby)	3710210693000-IL
5	STBY ASSY	See Contrast table (2)	30	Insulator (PLS)	See Contrast table (2)
6	LED ASSY	See Contrast table (2)	31	Cushion (Foot)	4050211605000-IL
7	POWER LED ASSY	7028071384010-IL	32	Cushion (SR Sheet)	See Contrast table (2)
8	POWER SW ASSY	7028071385010-IL	33	Cushion (LCD)	4050213805000-IL
9	IR ASSY	7028071386010-IL	34	Supporter	4070001601010-IL
10	GUIDE 3 ASSY	7028071387010-IL	35	Support PCB	4070211583000-IL
11	CNT B ASSY	7028071388010-IL	36	Binder	4330040343010-IL
12	GUIDE 1 ASSY	7028071389010-IL	37	Fastener	4420040243010-IL
13	GUIDE 4 ASSY	702807138B010-IL	38	Window	5077213233000-IL
14	JACK ASSY	See Contrast table (2)	39	Knob ASSY	See Contrast table (2)
15	LCD/KEY ASSY	7028071392010-IL	40	Screw	ABZ30P080FTC
16	CNT A ASSY	7028071393010-IL	41	Screw	B020230063B10-IL
⚠ 17	Power Trans	See Contrast table (2)	42	Screw	BBZ30P060FTC
⚠ 18	Power Trans	See Contrast table (2)	43	Screw	See Contrast table (2)
19	Socket, Power AC	G430040560021-IL	44	Screw	BBZ30P080FTC
20	Display, LCD	K550240600010-IL	45	Screw, Tap Tite	See Contrast table (2)
21	PIONEER Badge (AL)	See Contrast table (2)	46	Screw	B020030171B10-IL
22	Sheet (Himelon)	1210211749000-IL	47	Screw, Tap Tite	BBZ30P060FTB
23	Cabinet	See Contrast table (2)	48	Screw, Tap Tite	B020230083B10-IL
24	Front Panel	See Contrast table (2)	49	Screw	B028940101B11-IL
25	Back Chassis	See Contrast table (2)	50	Screw	CBZ30P080FTB
			51	Screw	1500001206020-IL
			52	Screw	See Contrast table (2)
			NSP 53	Serial Label	RRW-168
			NSP 54	Main Chassis	3200214066000-IL

**(2) CONTRAST TABLE**

N-50/CUXE, N-50-K-/SYXE8, N-50-S/SYXE8, N-30/CUXE, N-30-K-/SYXE8 and N-30-S/SYXE8 are constructed the same except for the following:

Mark No.	Symbol and Description	N-50/CUXE	N-50-K-/SYXE8	N-50-S/SYXE8	N-30/CUXE	N-30-K-/SYXE8	N-30-S/SYXE8
1	D-MAIN ASSY	7028071361010-IL	7028071361010-IL	7028071361010-IL	7028071361020-IL	7028071361020-IL	7028071361020-IL
3	GUIDE 2 ASSY	702807138A010-IL	702807138A010-IL	702807138A010-IL	Not used	Not used	Not used
4	DAC ASSY	7028071381010-IL	7028071381010-IL	7028071381010-IL	7028071381020-IL	7028071381020-IL	7028071381020-IL
5	STBY ASSY	7028071382010-IL	7028071382020-IL	7028071382020-IL	7028071382030-IL	7028071382040-IL	7028071382040-IL
6	LED ASSY	7028071383010-IL	7028071383010-IL	7028071383010-IL	7028071383020-IL	7028071383020-IL	7028071383020-IL
14	JACK ASSY	7028071391010-IL	7028071391010-IL	7028071391010-IL	7028071391020-IL	7028071391020-IL	7028071391020-IL
⚠ 17	Power Trans	8200570300120-IL	8200570300130-IL	8200570300130-IL	Not used	Not used	Not used
⚠ 18	Power Trans	8200660300120-IL	8200660300130-IL	8200660300130-IL	8200660300150-IL	8200660300160-IL	8200660300160-IL
21	PIONEER Badge (AL)	PAN1376	BAM1004	VAM1124	PAN1376	BAM1004	VAM1124
23	Cabinet	3007211956010-IL	3007211956010-IL	3007211956000-IL	3007211956010-IL	3007211956010-IL	3007211956000-IL
24	Front Panel	3067215358130-IL	3067215358100-IL	3067215358110-IL	3067215358010-IL	3067215358020-IL	3067215358000-IL
25	Back Chassis	3207214076130-IL	3207214076120-IL	3207214076140-IL	3207214076010-IL	3207214076020-IL	3207214076030-IL
26	Bottom Chassis	3207214086000-IL	3207214086000-IL	3207214086000-IL	Not used	Not used	Not used
27	Panel Frame	3210212191100-IL	3210212191100-IL	3217212191300-IL	3210212191100-IL	3210212191100-IL	3217212191300-IL
28	Lens (Remocon)	3710210683000-IL	3710210683000-IL	3710210683100-IL	3710210683000-IL	3710210683000-IL	3710210683100-IL
30	Insulator (PLS)	4000210391000-IL	4000210391000-IL	4007210391000-IL	4000210391000-IL	4000210391000-IL	4007210391000-IL
32	Cushion (SR Sheet)	4050213795000-IL	4050213795000-IL	4050213795000-IL	Not used	Not used	Not used
39	Knob ASSY	5088211391400-IL	5088211391400-IL	5088211391300-IL	5088211391400-IL	5088211391400-IL	5088211391300-IL
43	Screw	BBZ30P080FTB	BBZ30P080FTB	BBZ30P080FNI	BBZ30P080FTB	BBZ30P080FTB	BBZ30P080FNI
45	Screw, Tap Tite	B020030083B11-IL	B020030083B11-IL	B020030083B11-IL	Not used	Not used	Not used
52	Screw	1500040083B10-IL	1500040083B10-IL	1500040084B10-IL	1500040083B10-IL	1500040083B10-IL	1500040084B10-IL

# 10. SCHEMATIC DIAGRAM

## 10.1 JACK ASSY

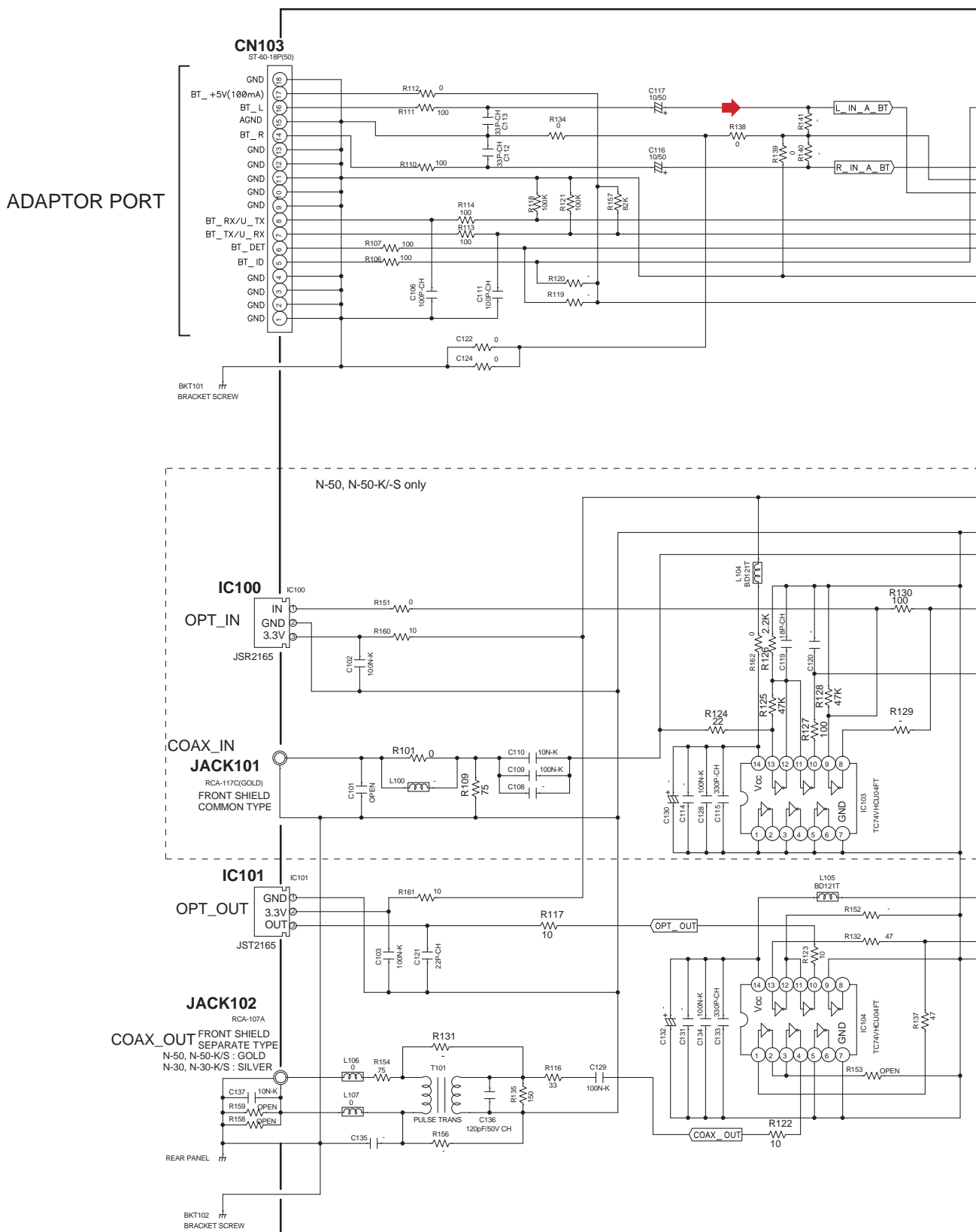

**A JACK ASSY**  
**(N-50, N-50-K/-S: 7028071391010-IL)**  
**(N-30, N-30-K/-S: 7028071391020-IL)**

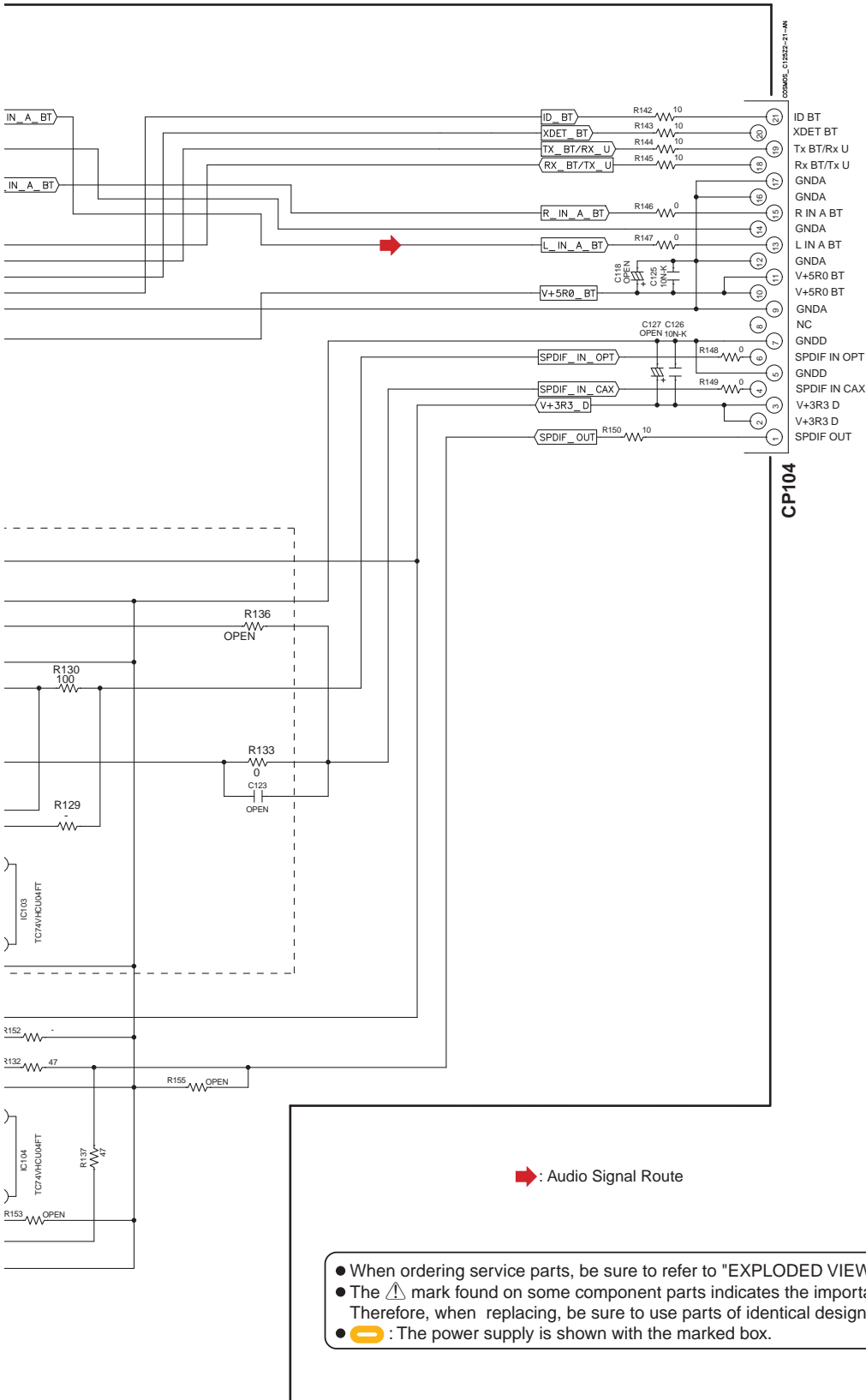

**K**  
 CN104

CP104

➔ : Audio Signal Route

- When ordering service parts, be sure to refer to "EXPLODED VIEWS and PARTS LIST" or "PCB PARTS LIST".
- The ⚠ mark found on some component parts indicates the importance of the safety factor of the part. Therefore, when replacing, be sure to use parts of identical designation.
-  : The power supply is shown with the marked box.

# 10.2 D-MAIN ASSY (1/5)

1

2

3

4

A

B

C

D

E

F

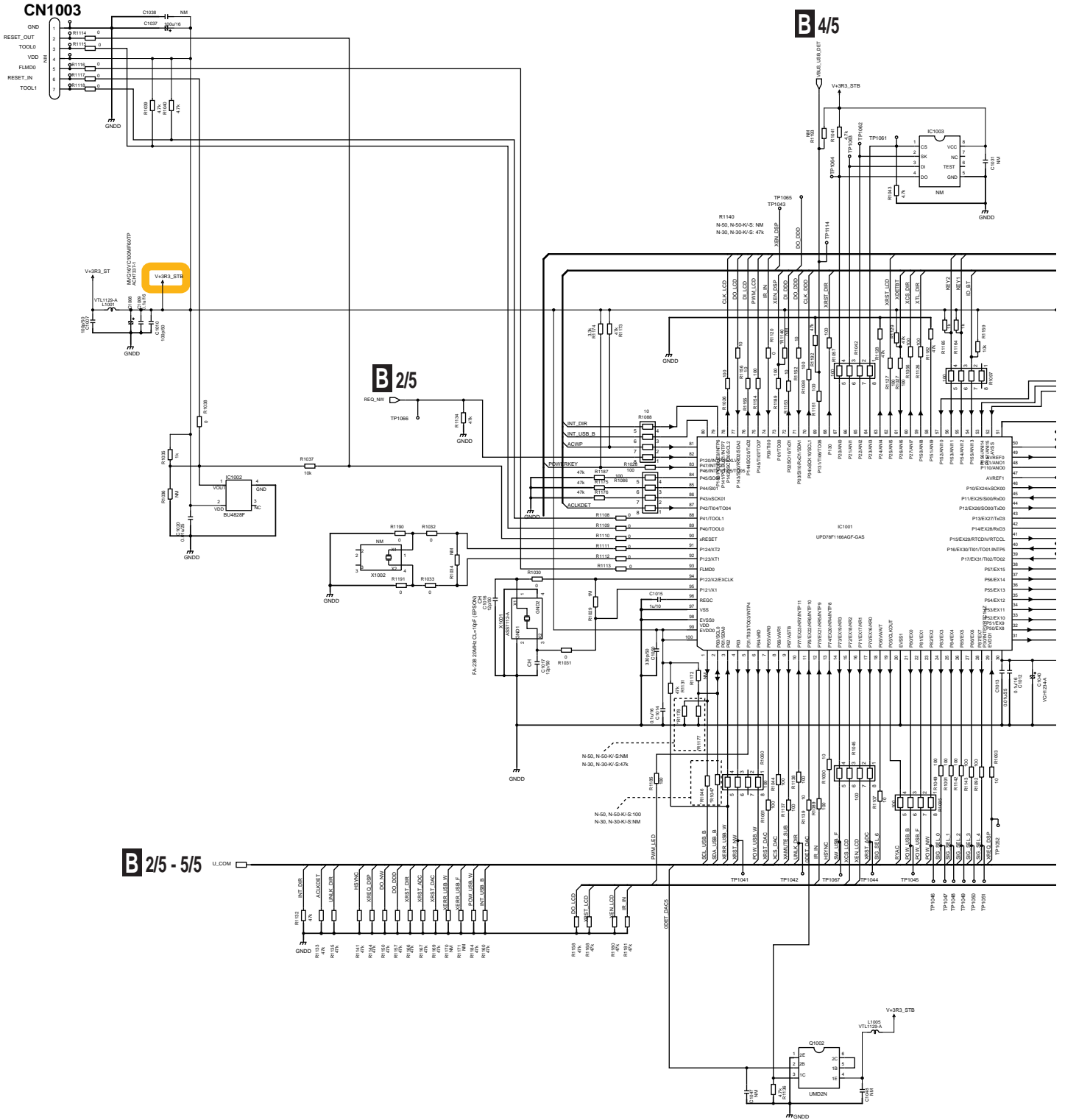

1

2

3

4



# 10.3 D-MAIN ASSY (2/5)

A  
B  
C  
D  
E  
F

The  
There

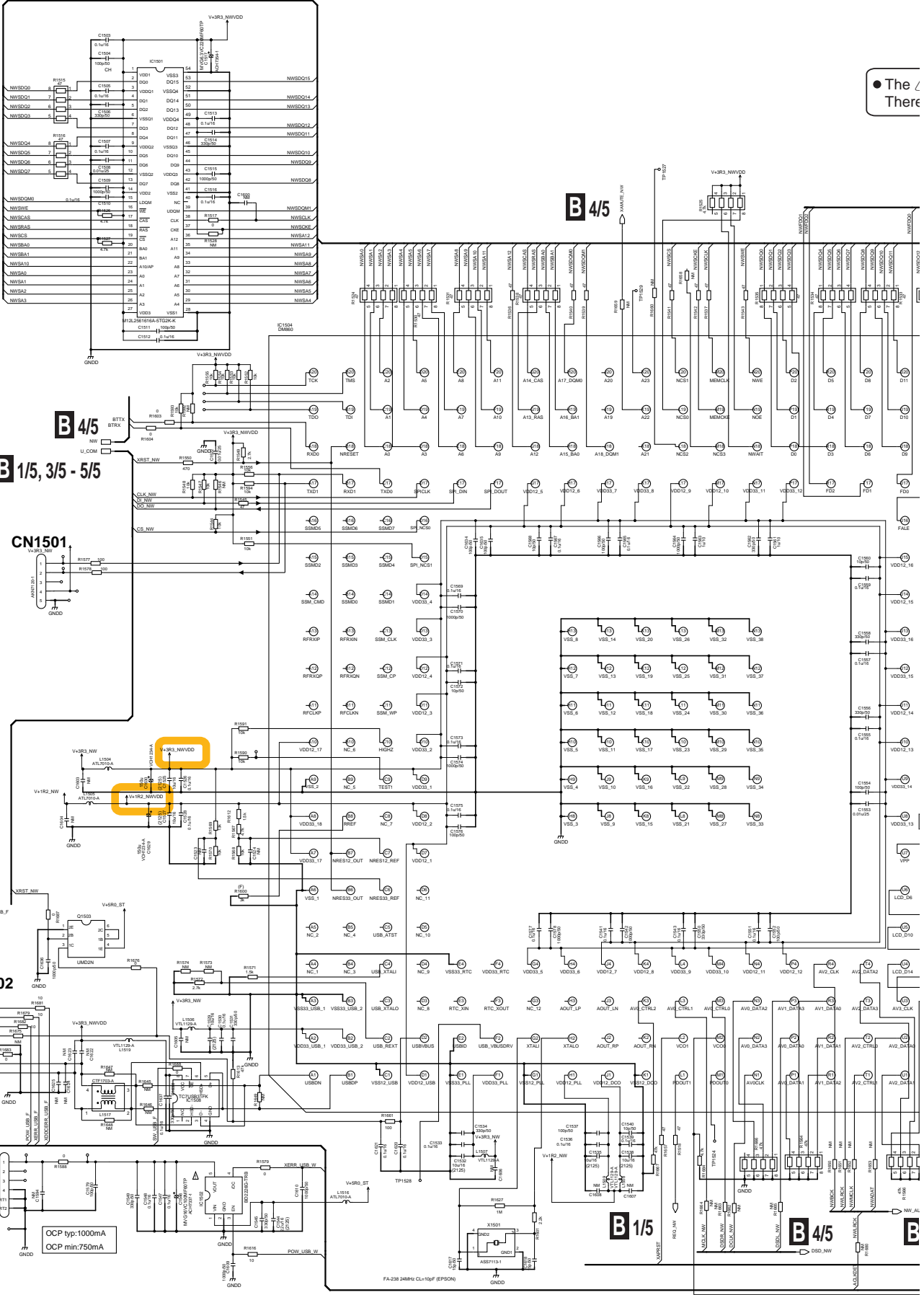

B 2/5



# B<sup>2/5</sup> D-MAIN ASSY (2/5)

(N-50, N-50-K/-S: 7028071361010-IL)  
 (N-30, N-30-K/-S: 7028071361020-IL)

• The  mark found on some component parts indicates the importance of the safety factor of the part. Therefore, when replacing, be sure to use parts of identical designation.

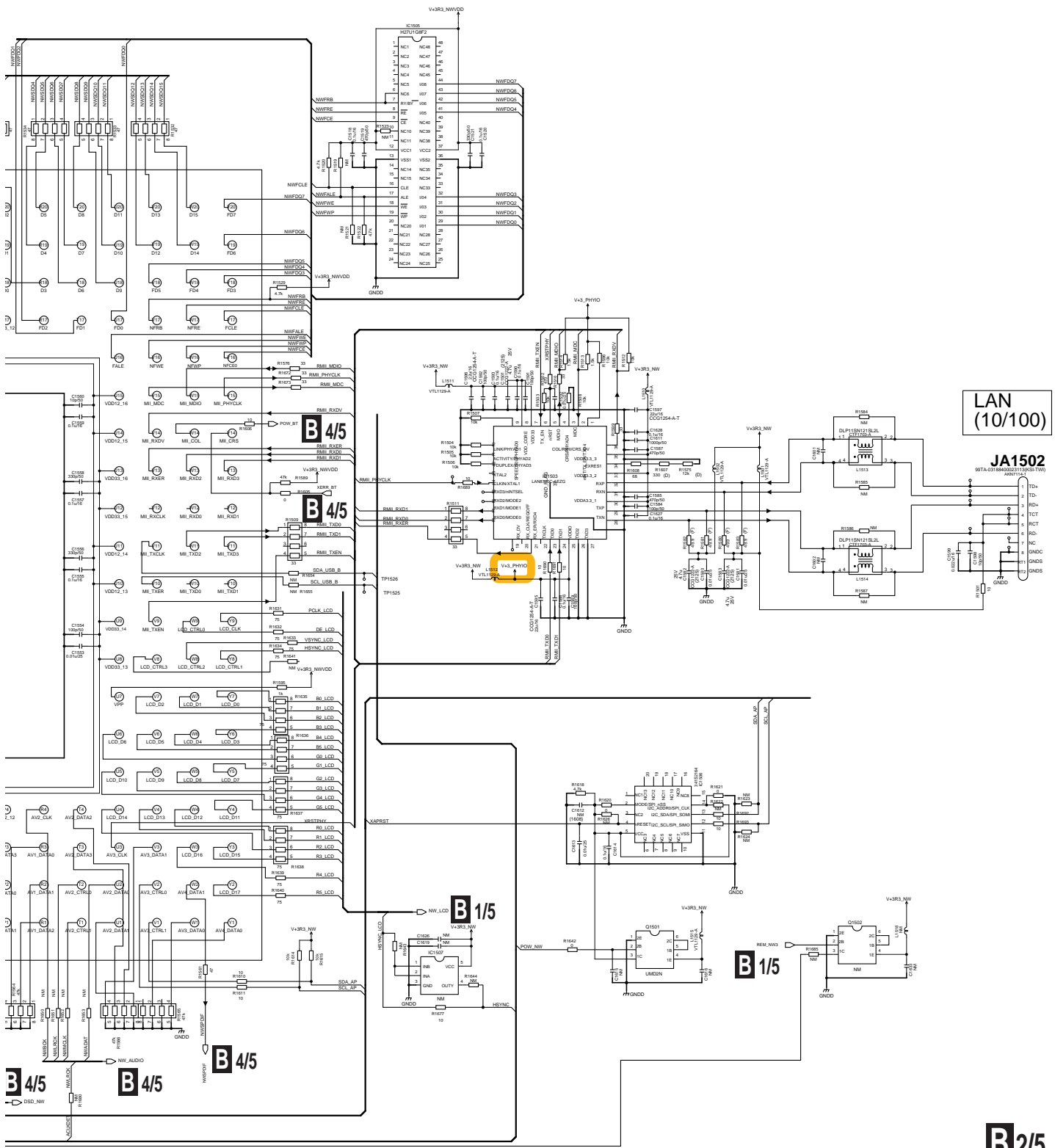

# 10.4 D-MAIN ASSY (3/5)

A

B

C

D

E

F

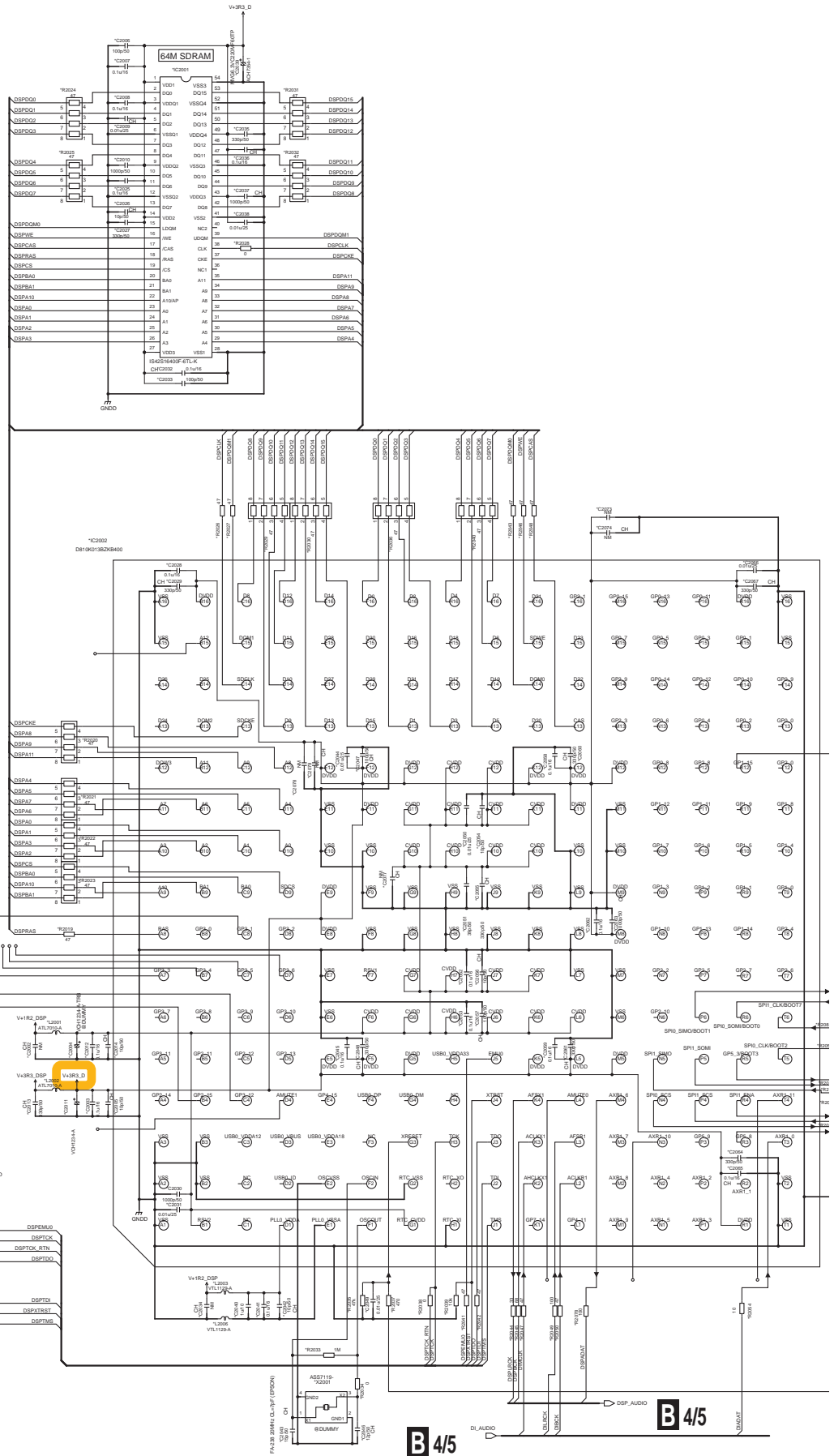

**B** 3/5

**B** 4/5

**B** 4/5

1

2

3

4

**B**<sup>3/5</sup> D-MAIN ASSY (3/5)  
(N-50, N-50-K/-S: 7028071361010-IL) A

**B** 1/5, 2/5, 4/5, 5/5

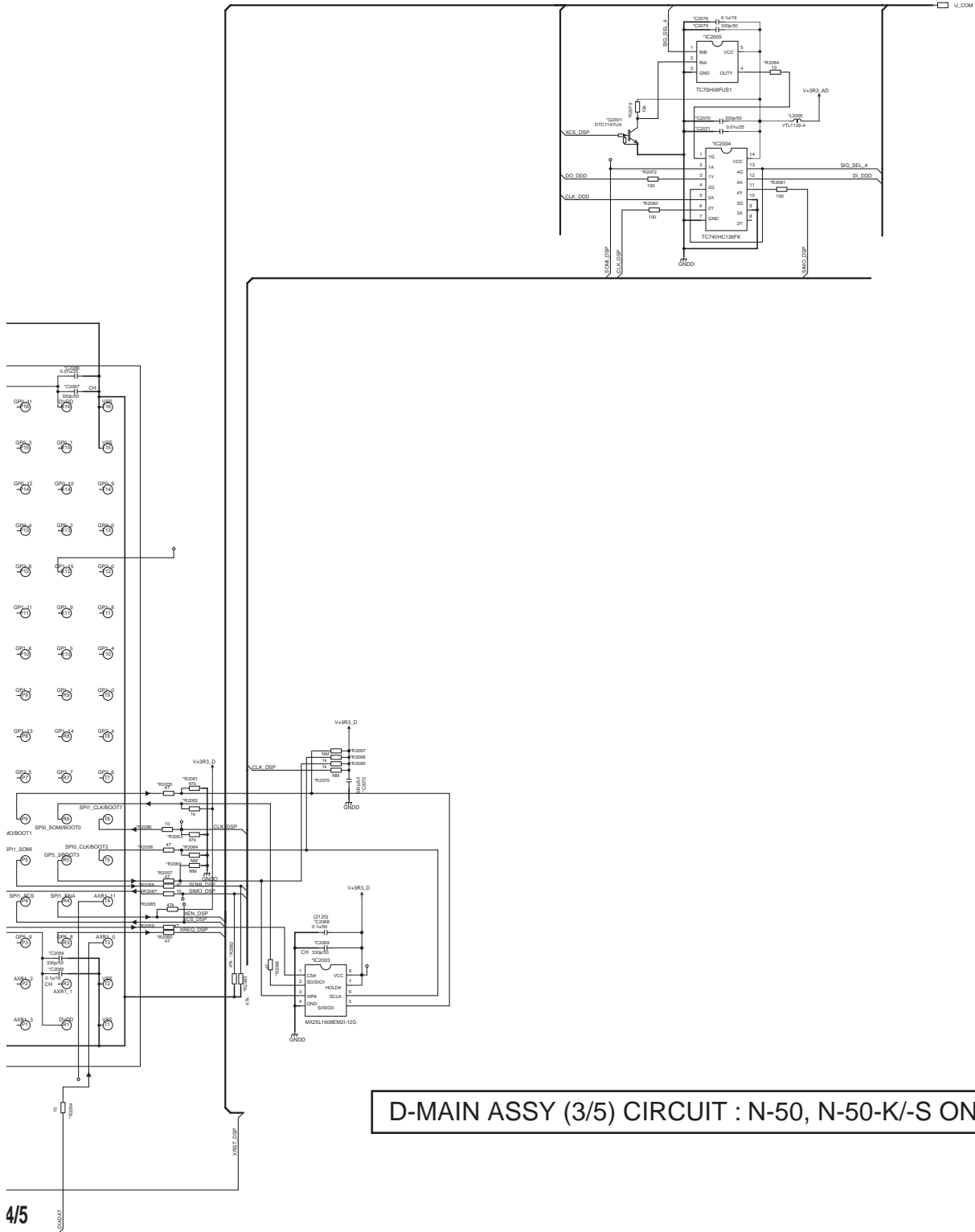

D-MAIN ASSY (3/5) CIRCUIT : N-50, N-50-K/-S ONLY

4/5

# 10.5 D-MAIN ASSY (4/5)

A

B 1/5 - 3/5, 5/5

B 2/5

B

C

CP105

K

CP105

E

B 2/5

B 1/5

B 5/5

F

B 4/5

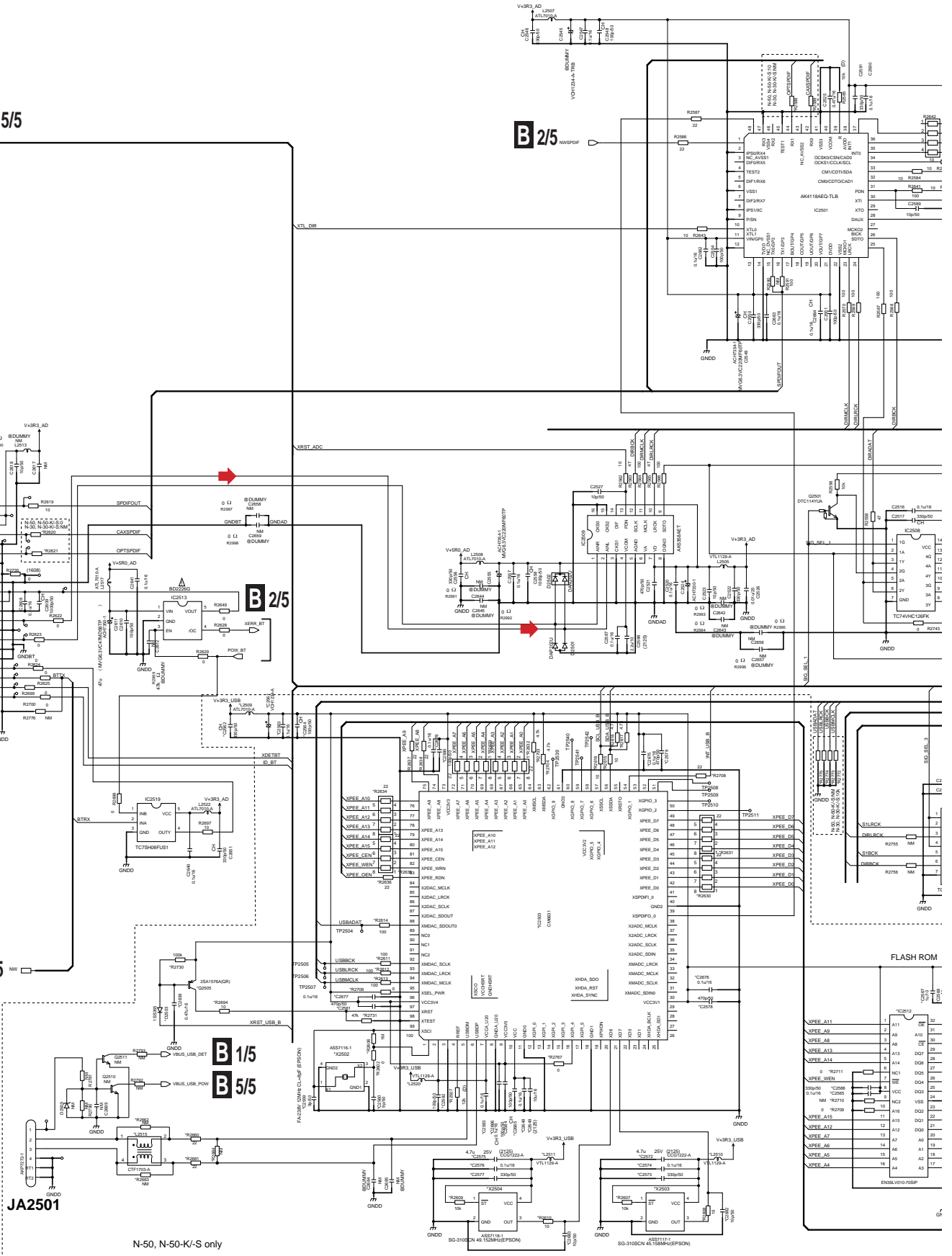

N-50, N-50-K/S only

52

N-50



# 10.6 D-MAIN ASSY (5/5)

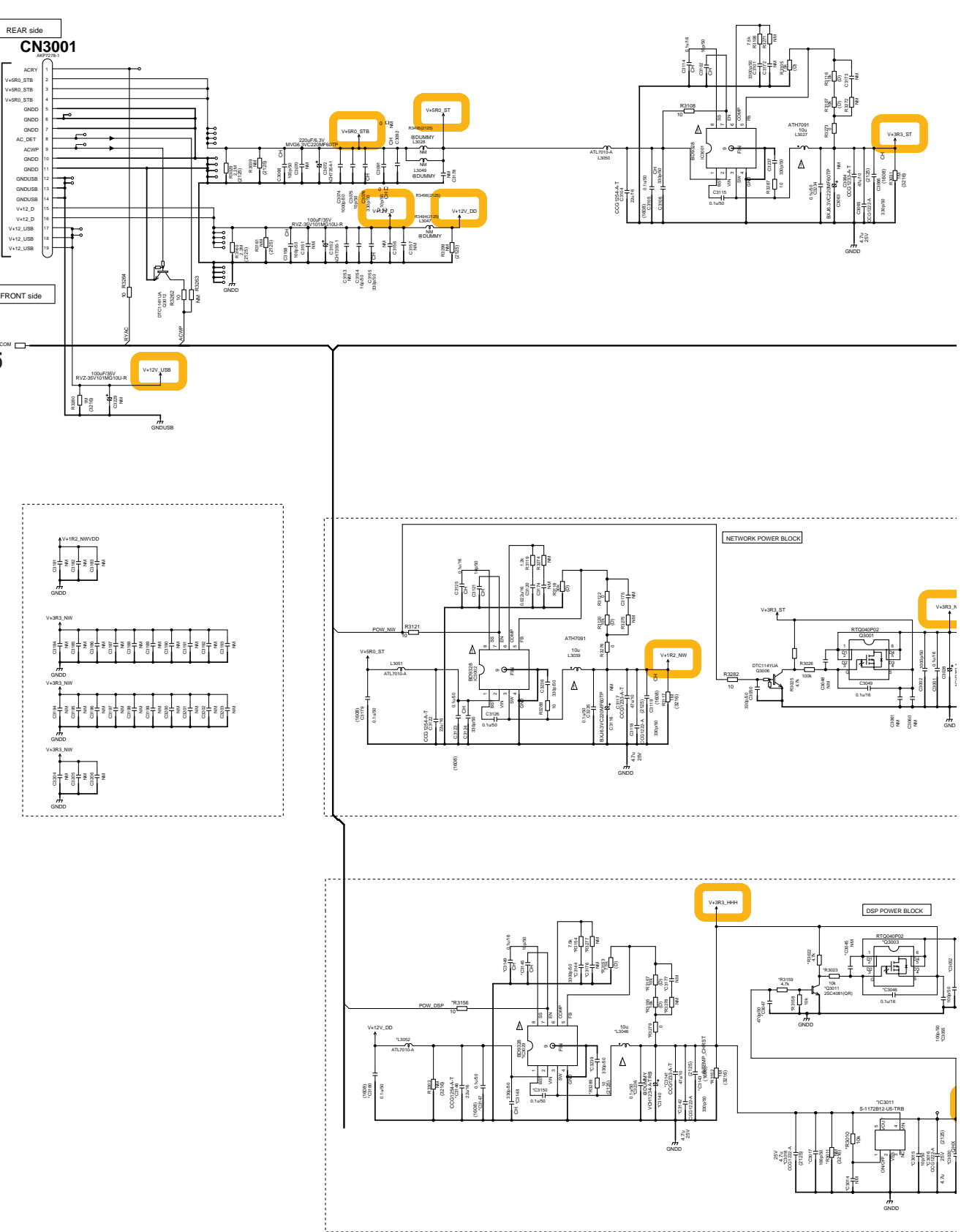

**J** CN205

**B** 1/5 - 4/5

• The  $\triangle$  mark found on some component parts indicates the importance of the safety factor of the part. Therefore, when replacing, be sure to use parts of identical designation.

**B5/5** D-MAIN ASSY (5/5)  
 (N-50, N-50-K/-S: 7028071361010-IL)  
 (N-30, N-30-K/-S: 7028071361020-IL)

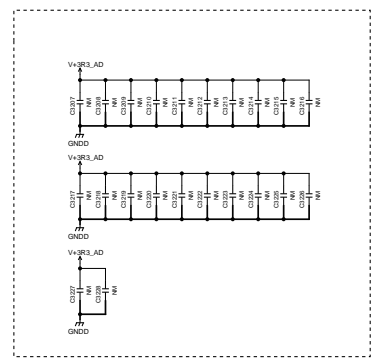
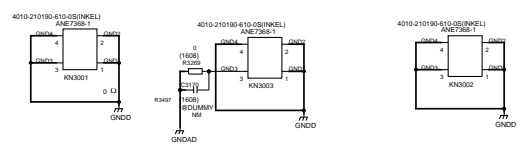
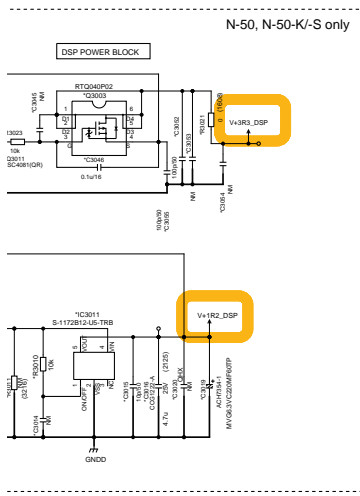
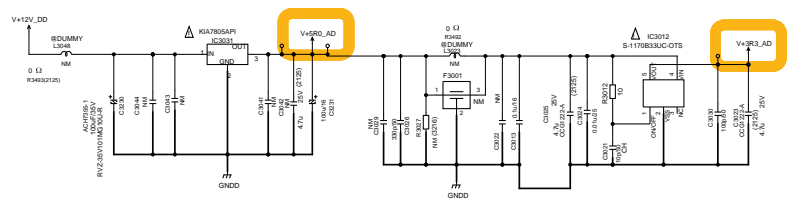
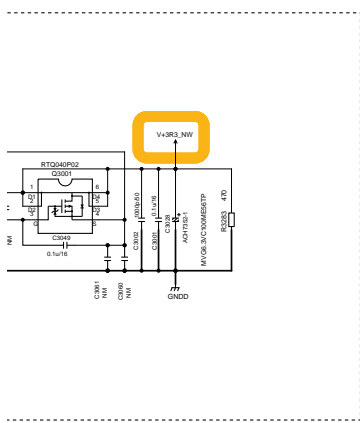
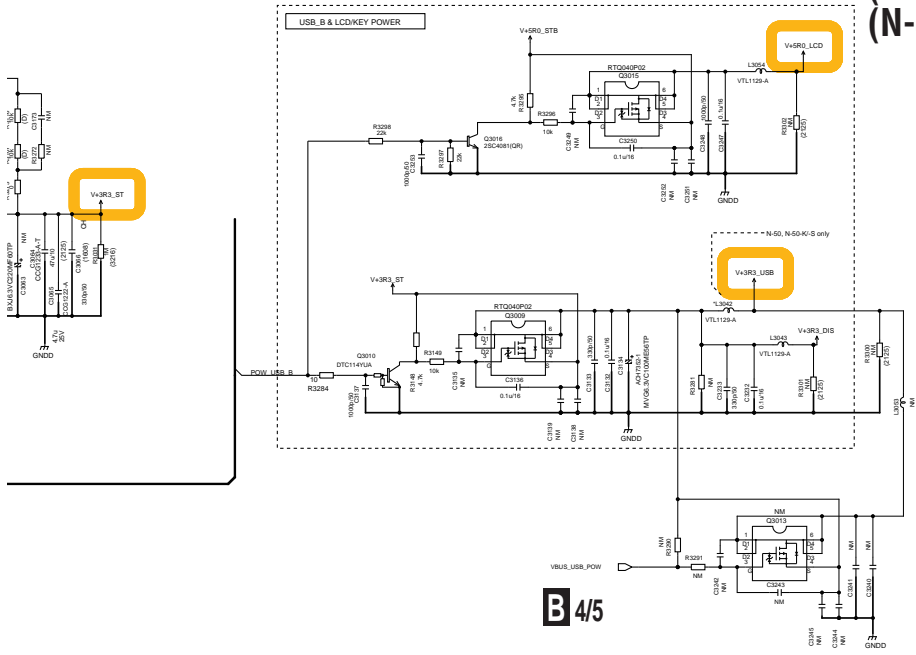

# 10.7 DAC ASSY

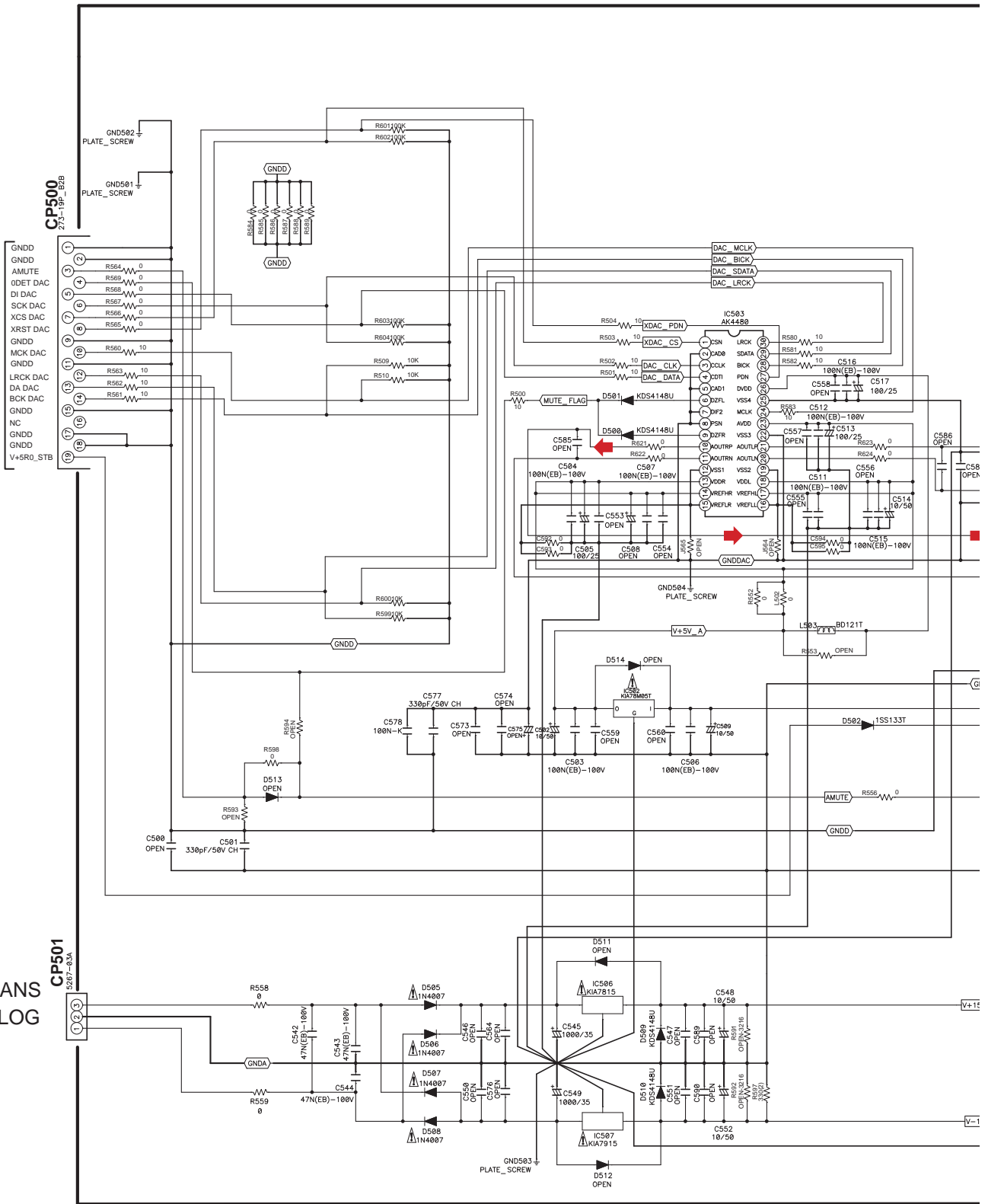

**B** 4/5  
CN2502

FROM TRANS  
FOR ANALOG

**C**



**C DAC ASSY**  
 (N-50, N-50-K/-S: 7028071381010-IL)  
 (N-30, N-30-K/-S: 7028071381020-IL)

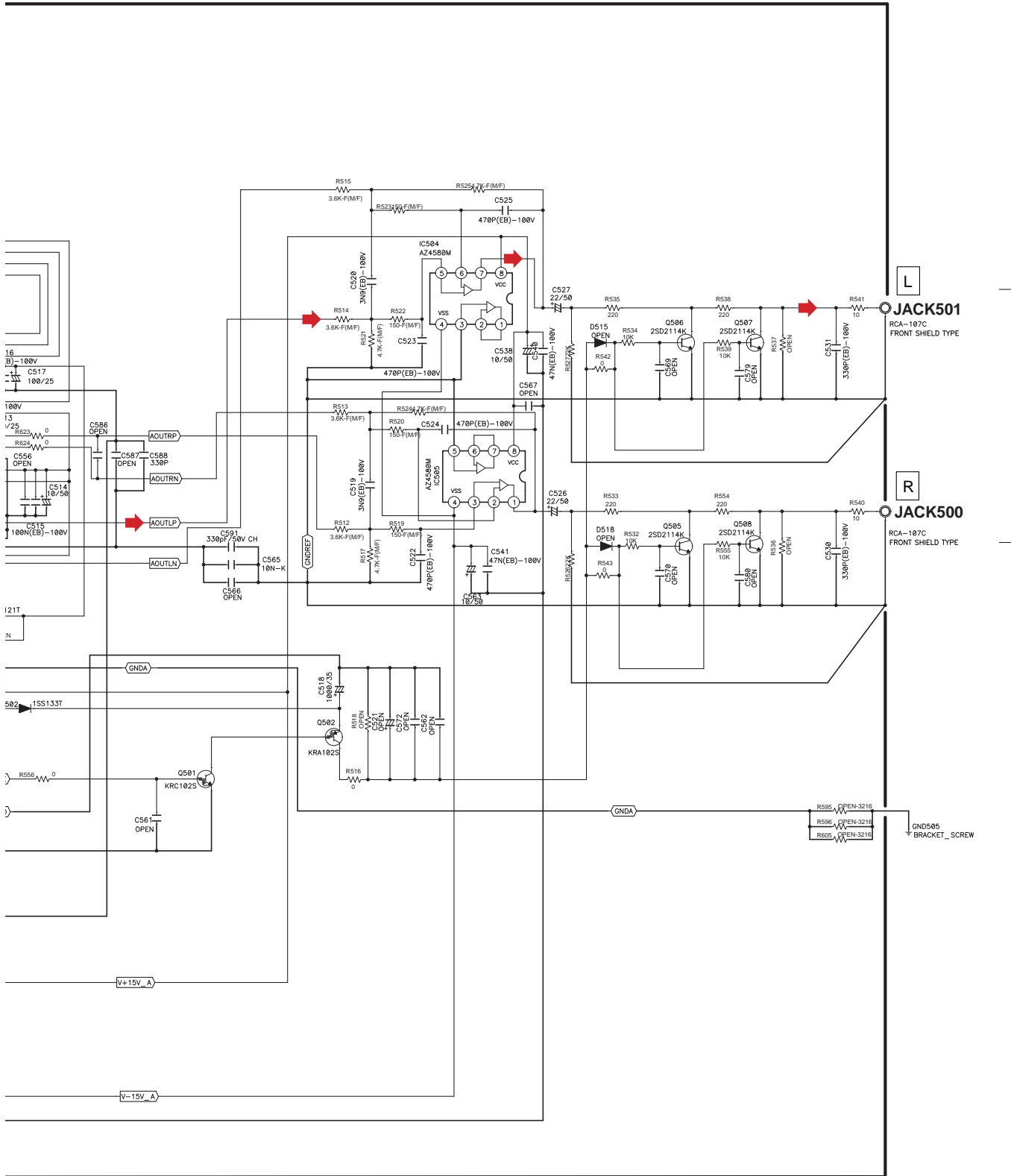

ANALOG OUT

➔ : Audio Signal Route

● The  $\Delta$  mark found on some component parts indicates the importance of the safety factor of the part. Therefore, when replacing, be sure to use parts of identical designation.



# 10.8 LCD/KEY ASSY

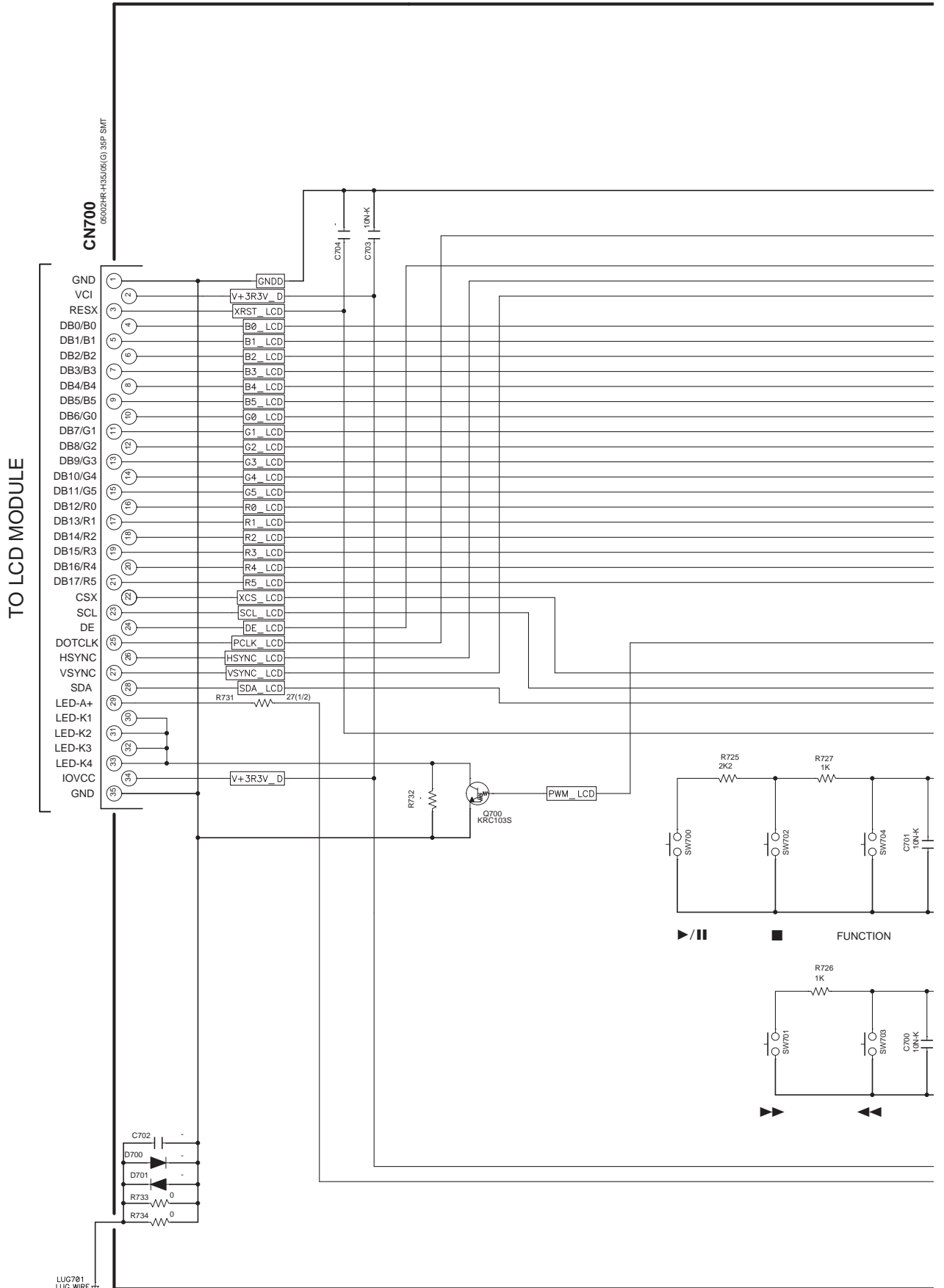

**D**

# D LCD/KEY ASSY (7028071392010-IL)

A  
B  
C  
D  
E  
F

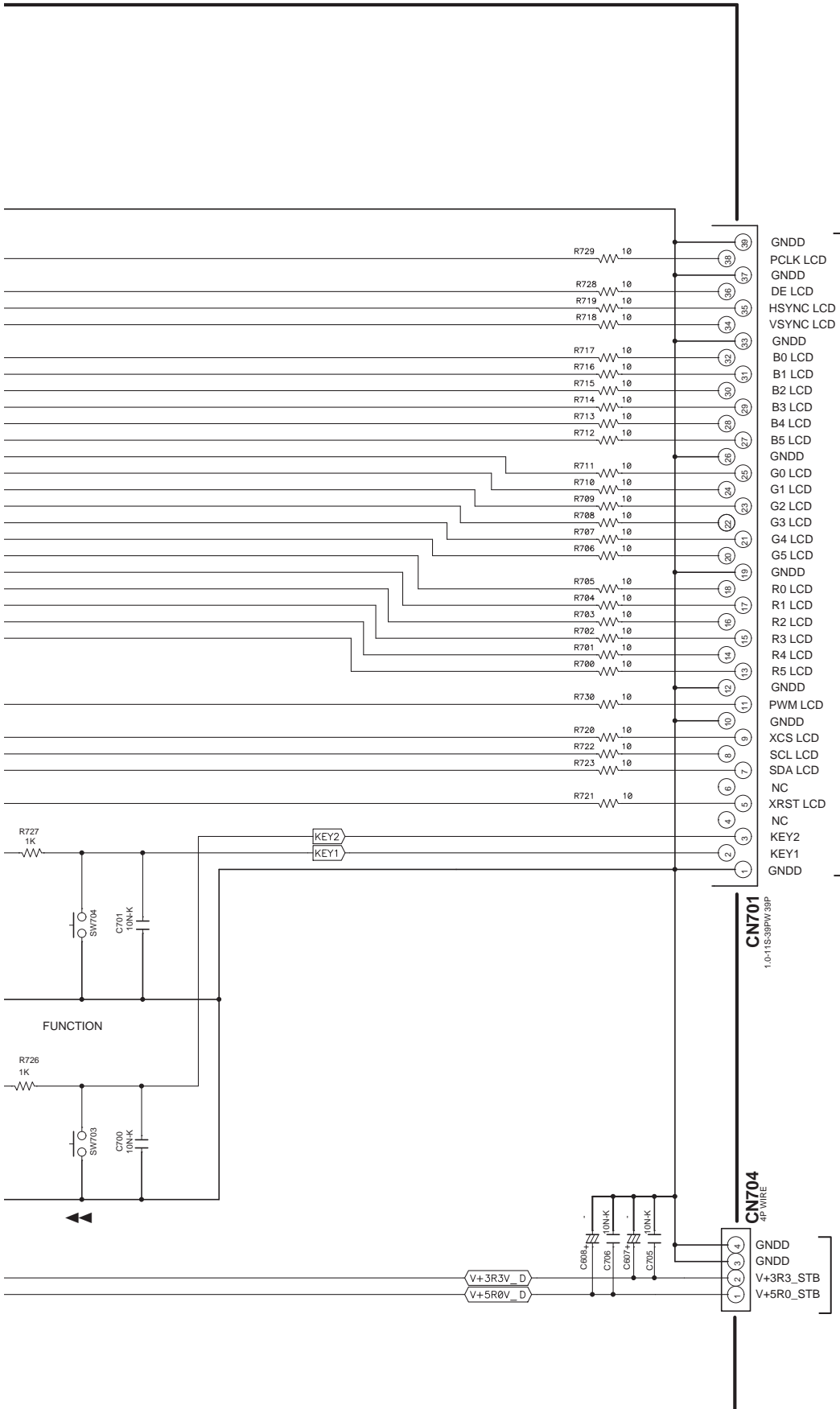

L FPC701

L CP702

# 10.9 LED ASSY, POWER SW ASSY, IR ASSY AND POWER LED ASSY

**F** POWER SW ASSY  
(7028071385010-IL)

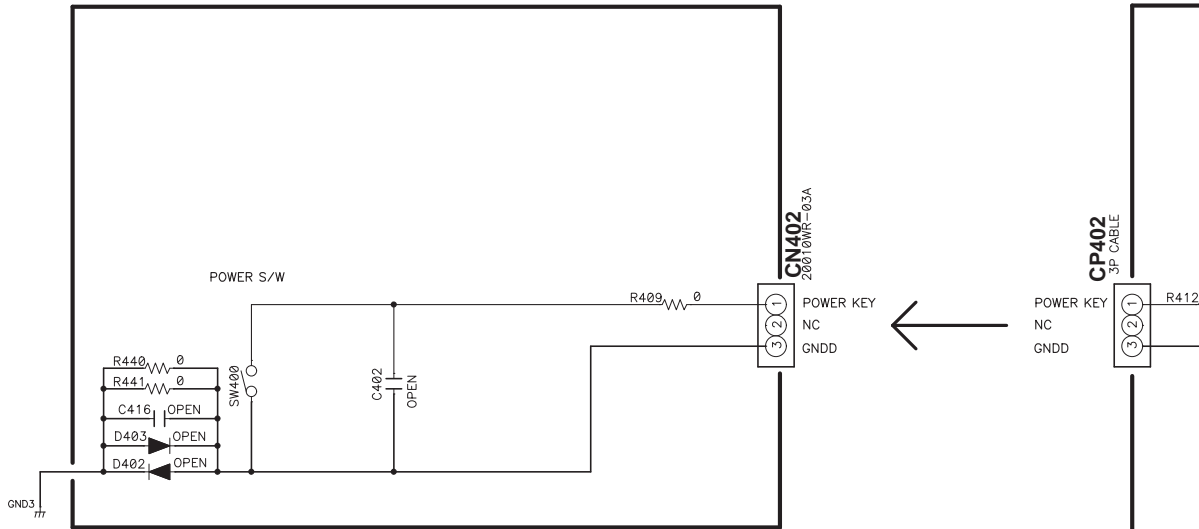

**G** IR ASSY  
(7028071386010-IL)

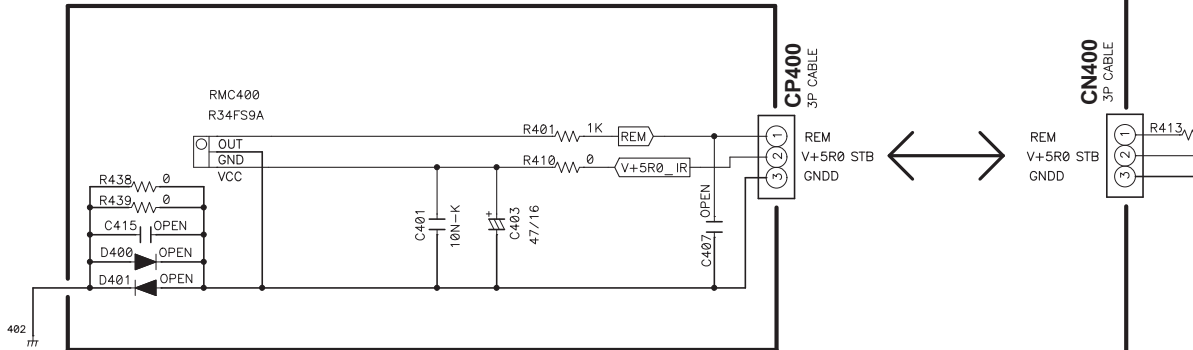

**H** POWER LED ASSY  
(7028071384010-IL)

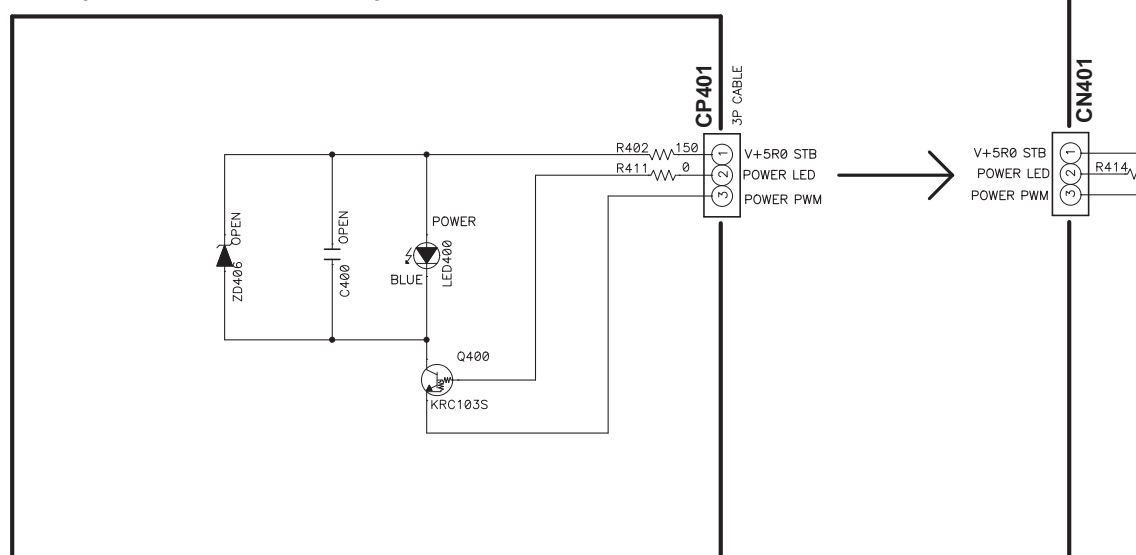

**E F G H**

**E LED ASSY**  
 (N-50, N-50-K/-S: 7028071383010-IL)  
 (N-30, N-30-K/-S: 7028071383020-IL)

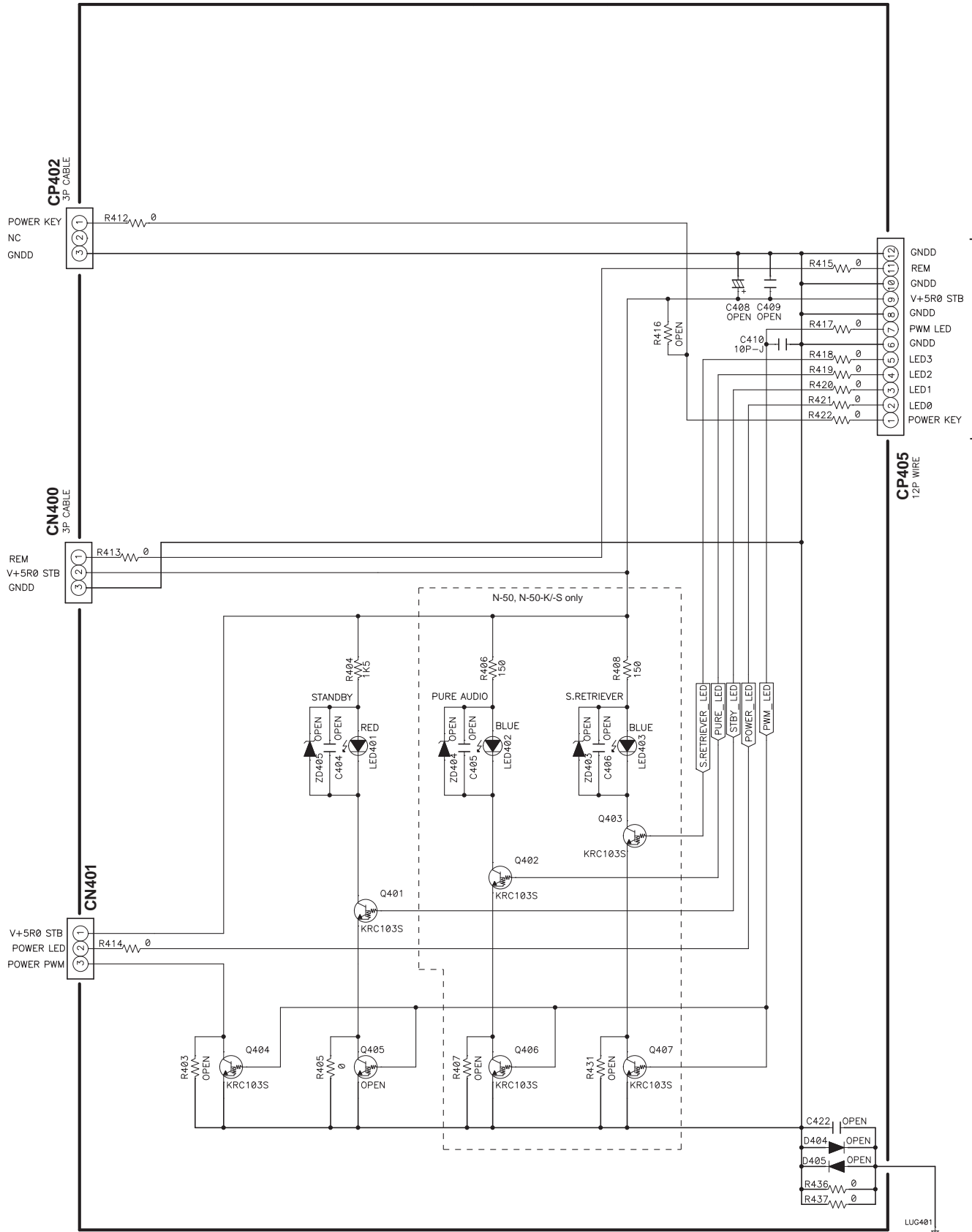

A  
B  
C  
D  
E  
F



# 10.10 USB ASSY

1

2

3

4

A

B

C

D

E

F

**L**  
CP703

**B 2/5**  
CN1502

CP600  
8P CABLE WITH SHIELD

CP601  
4P CABLE

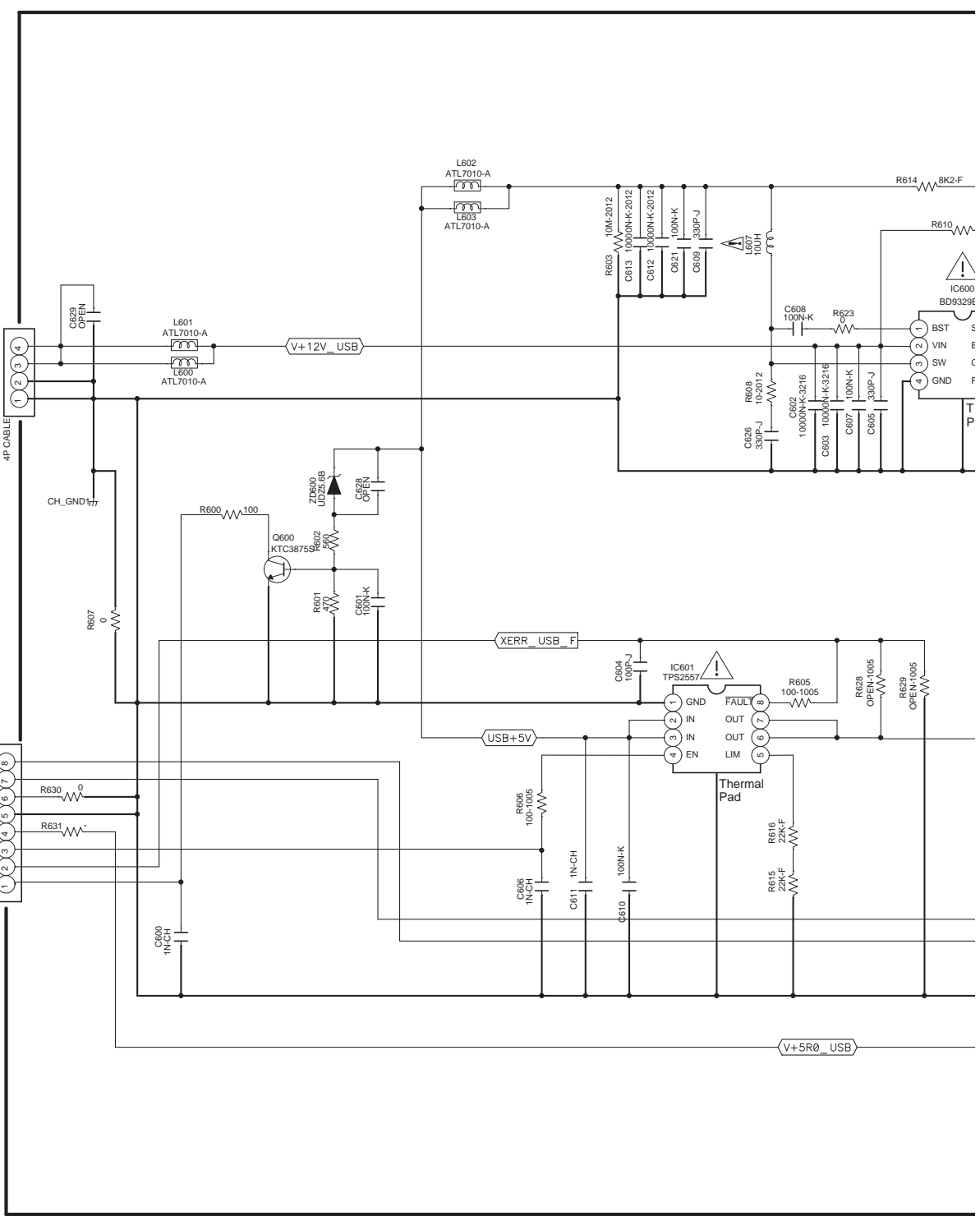

1

2

3

4

# USB ASSY (7028071371010-IL)

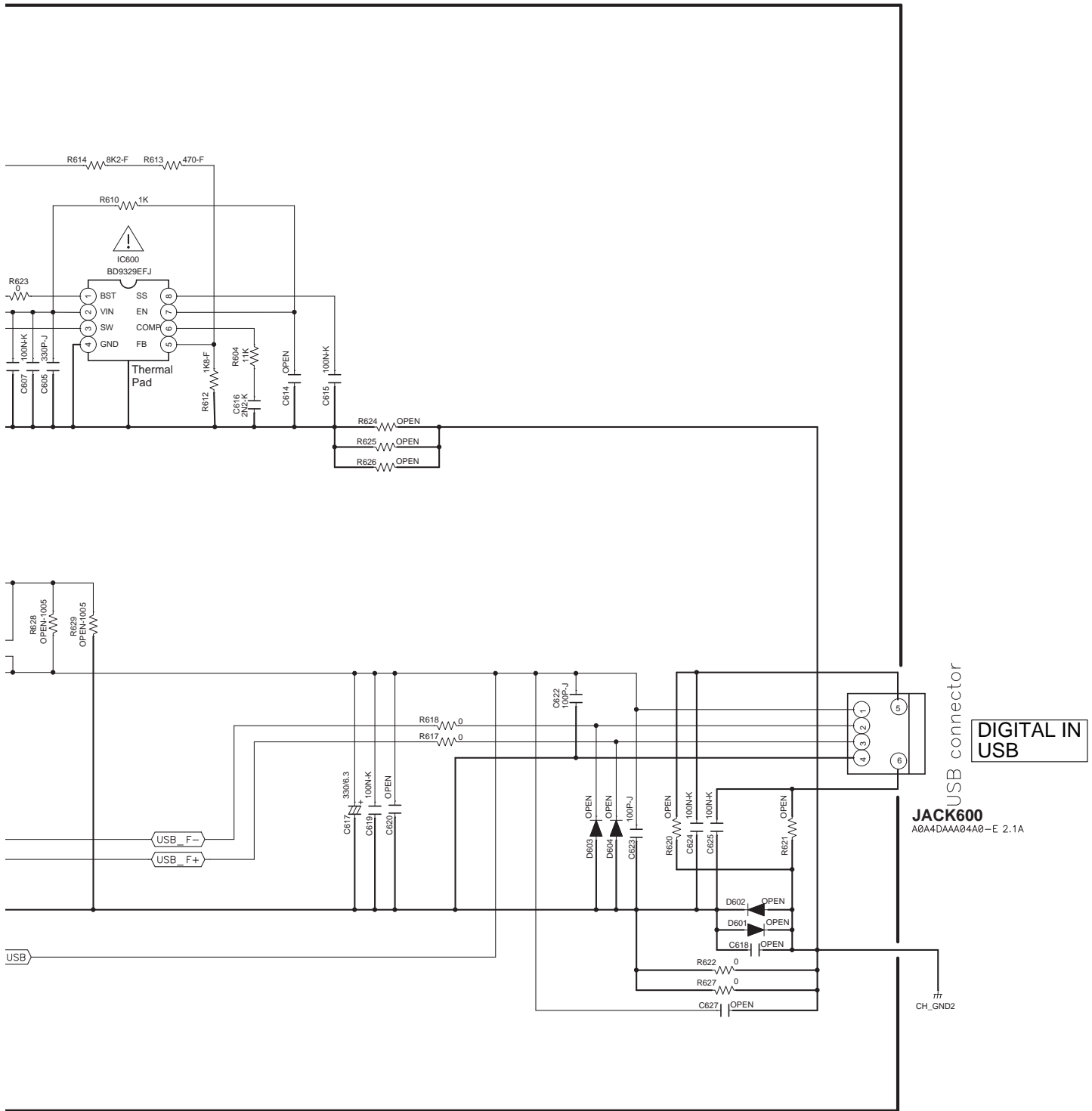

● The  mark found on some component parts indicates the importance of the safety factor of the part. Therefore, when replacing, be sure to use parts of identical designation.



# 10.11 STBY ASSY

A  
B  
C  
D  
E  
F

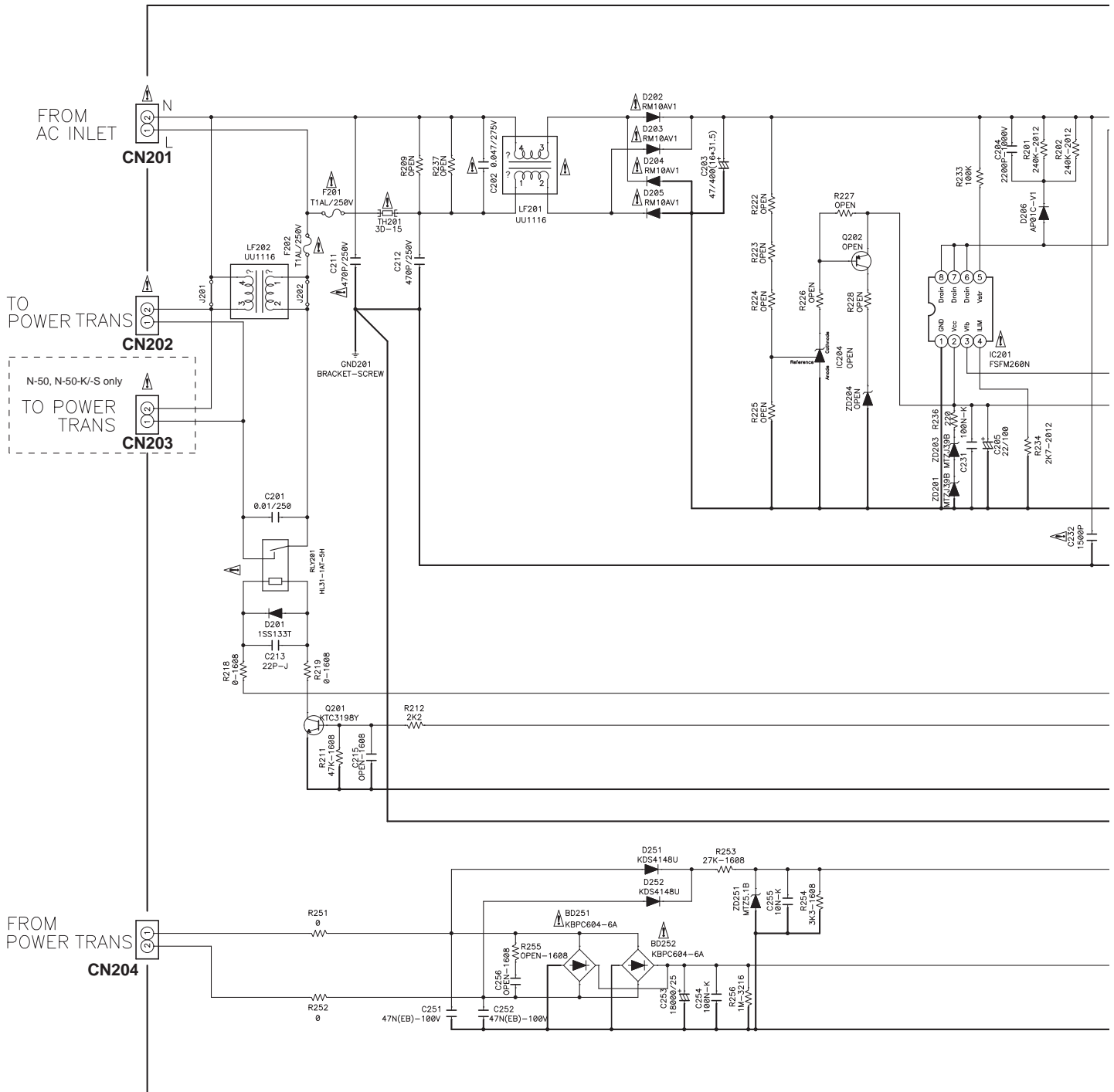

1 2 3 4



**J STBY ASSY**  
**(N-50 : 7028071382010-IL)**  
**(N-50-K/-S : 7028071382020-IL)**  
**(N-30 : 7028071382030-IL)**  
**(N-30-K/-S : 7028071382040-IL)**

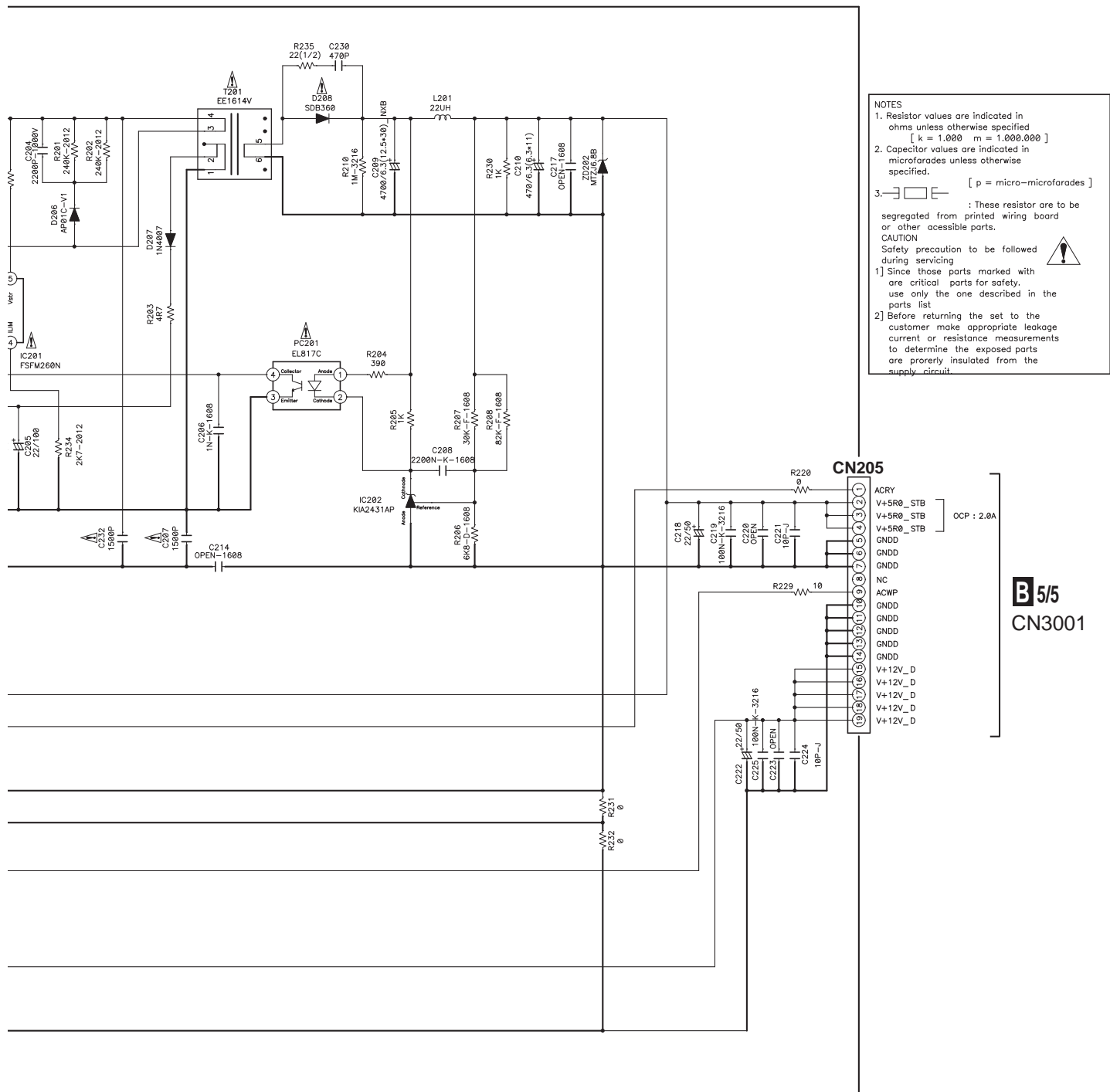

**NOTES**

- Resistor values are indicated in ohms unless otherwise specified [ k = 1,000 m = 1,000,000 ]
- Capacitor values are indicated in microfarades unless otherwise specified. [ p = micro-microfarades ]
- These resistor are to be segregated from printed wiring board or other accessible parts. **CAUTION** Safety precaution to be followed during servicing.
  - Since those parts marked with are critical parts for safety, use only the one described in the parts list
  - Before returning the set to the customer make appropriate leakage current or resistance measurements to determine the exposed parts are properly insulated from the supply circuit.

**B 5/5**  
CN3001

1 some component parts indicates the importance of the safety factor of the part. aging, be sure to use parts of identical designation.

INDICATES SAFETY CRITICAL COMPONENTS. TO REDUCE THE RISK OF ELECTRIC SHOCK, LEAKAGE CURRENT OR RESISTANCE MEASUREMENTS SHALL BE CARRIED OUT ( EXPOSED PARTS ARE ACCEPTABLY INSULATED FROM THE SUPPLY CIRCUIT ) BEFORE THE APPLIANCE RETURNED TO THE CUSTOMER.

# 10.12 CNT A ASSY AND CNT B ASSY

## K CNT A ASSY (7028071393010-IL)

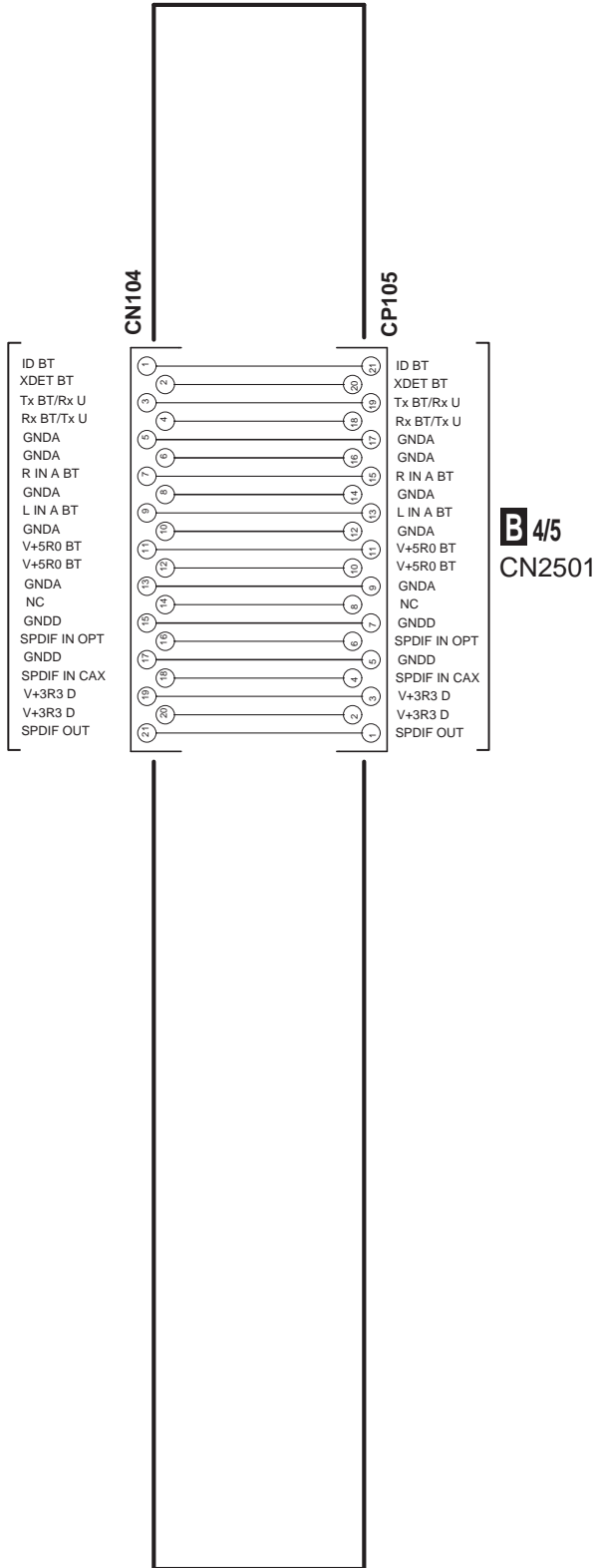

## L CNT B ASSY (7028071388010-IL)

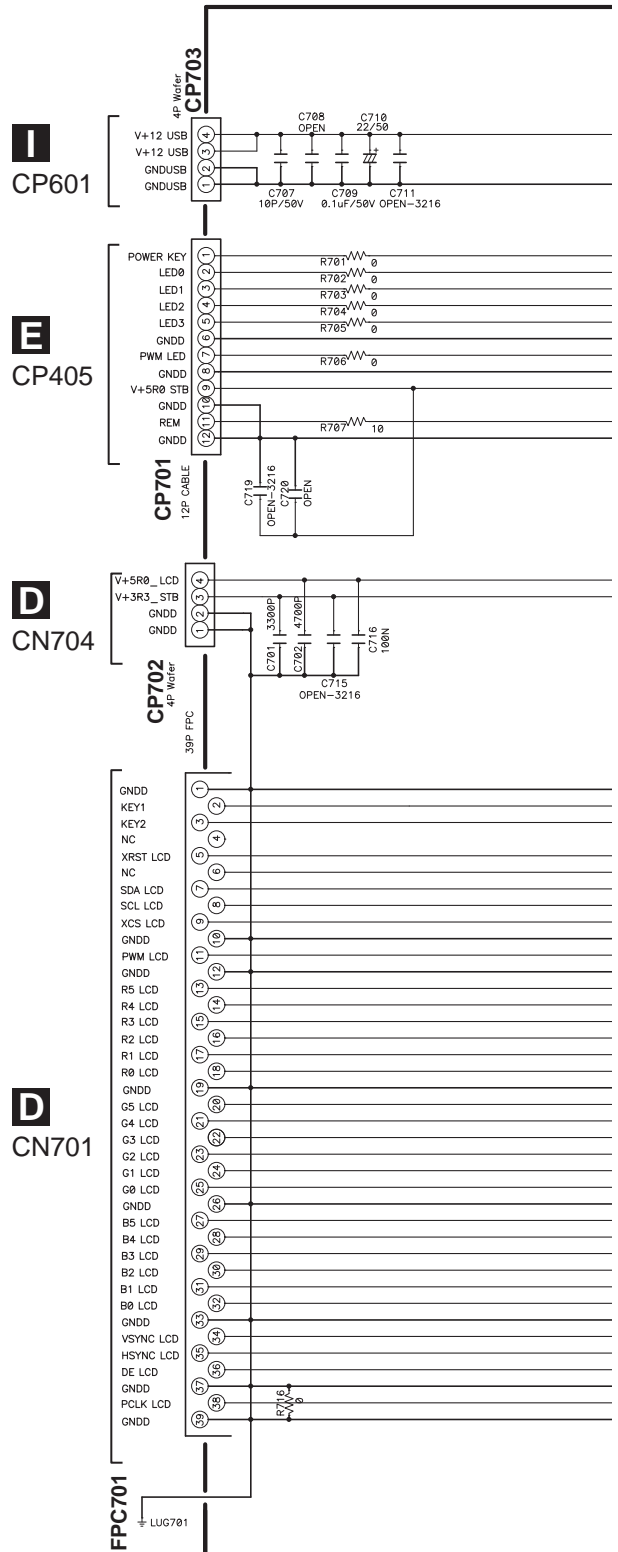

Y  
(88010-IL)

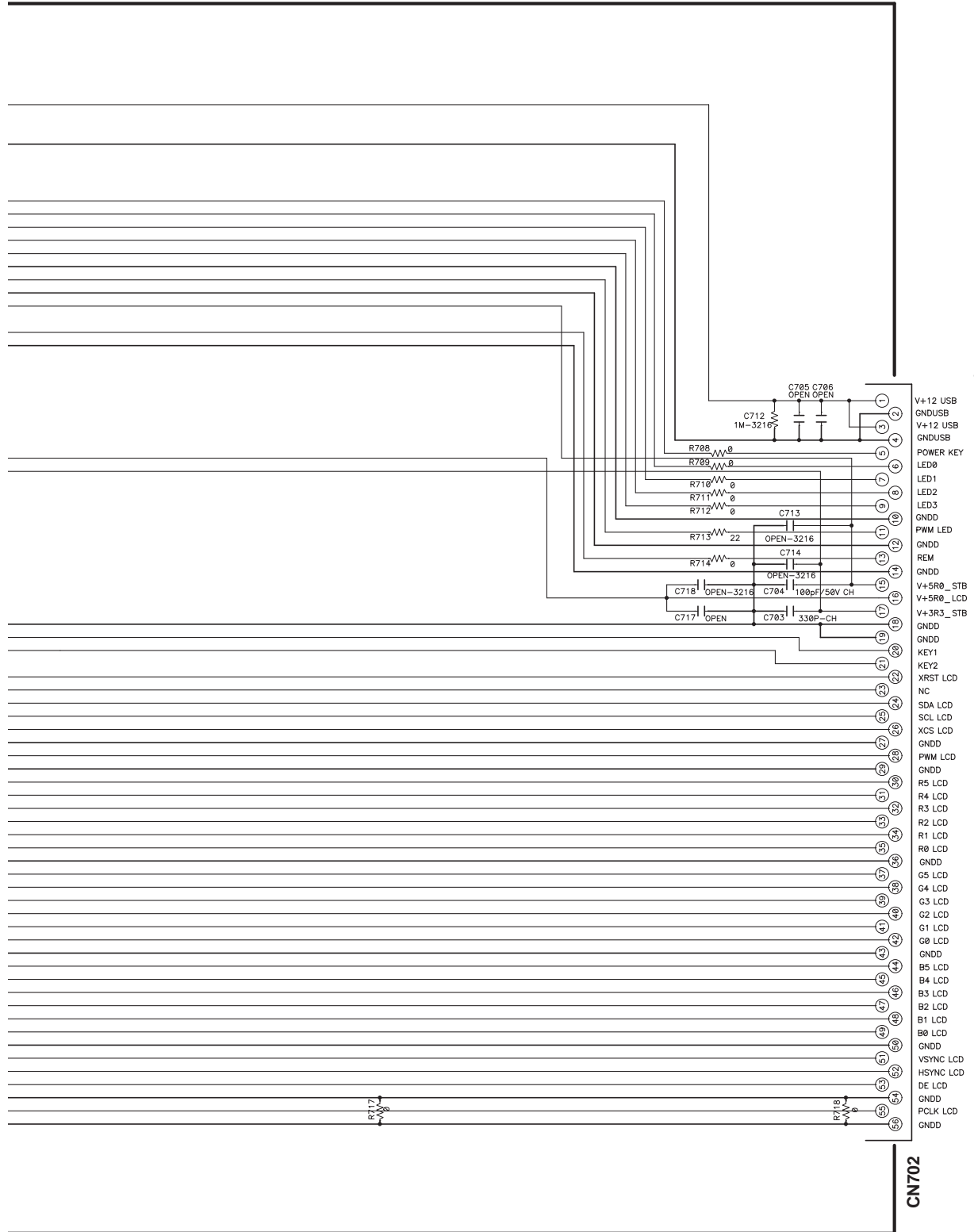

A  
B  
C  
D  
E  
F

1 ■ 2 ■ 3 ■ 4 ■  
10.13 GUIDE 1, GUIDE 2(N-50, N-50-K/-S ONLY), GUIDE 3 AND GUIDE 4 ASSYS

A

B

**M** GUIDE 1 ASSY  
(7028071389010-IL)

**N** GUIDE 2 ASSY  
(N-50, N-50-K/-S: 702807138A010-IL)

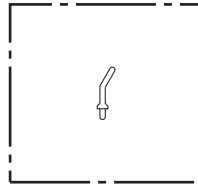

C

D

**O** GUIDE 3 ASSY  
(7028071387010-IL)

**P** GUIDE 4 ASSY  
(702807138B010-IL)

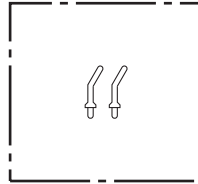

E

F

**M N O P**

**M N O P**

■

5

■

6

■

7

■

8

■

A

■

B

■

C

■

D

■

E

■

F

■

5

■

6

N-50

■

7

■

8

■

# 11. PCB CONNECTION DIAGRAM

## 11.1 JACK ASSY

**SIDE A**

**A JACK ASSY**

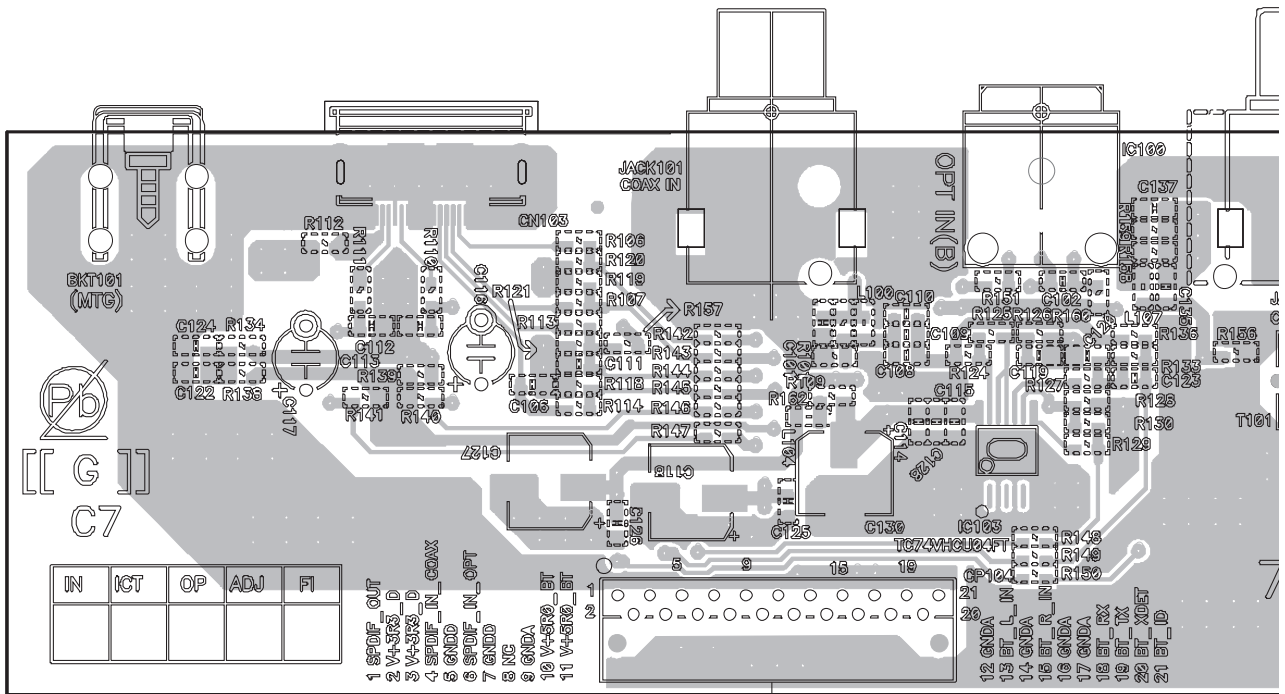

CP104

**K** CN104

**SIDE B**

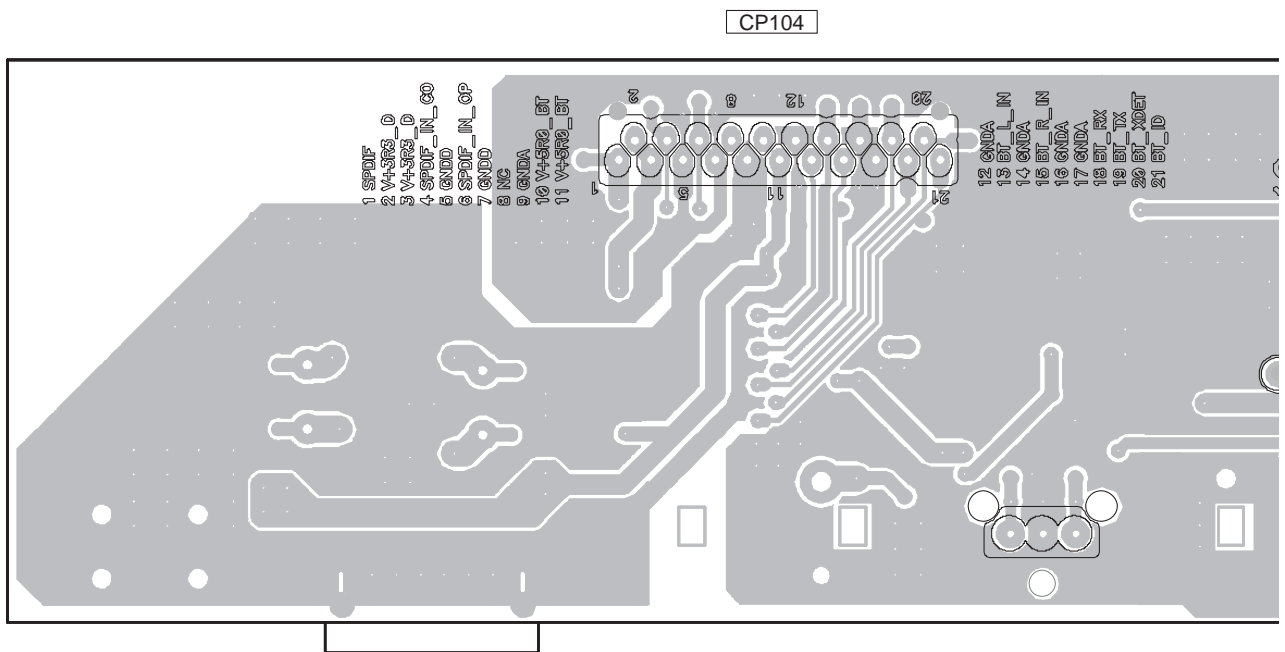

CP104

**A**

**SIDE A**

A

B

C

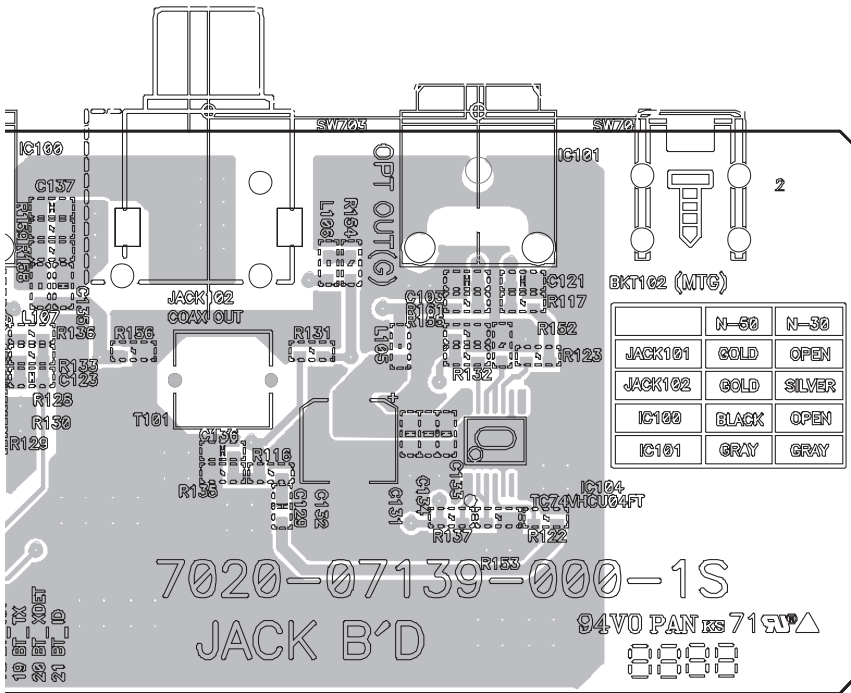

**SIDE B**

D

E

F

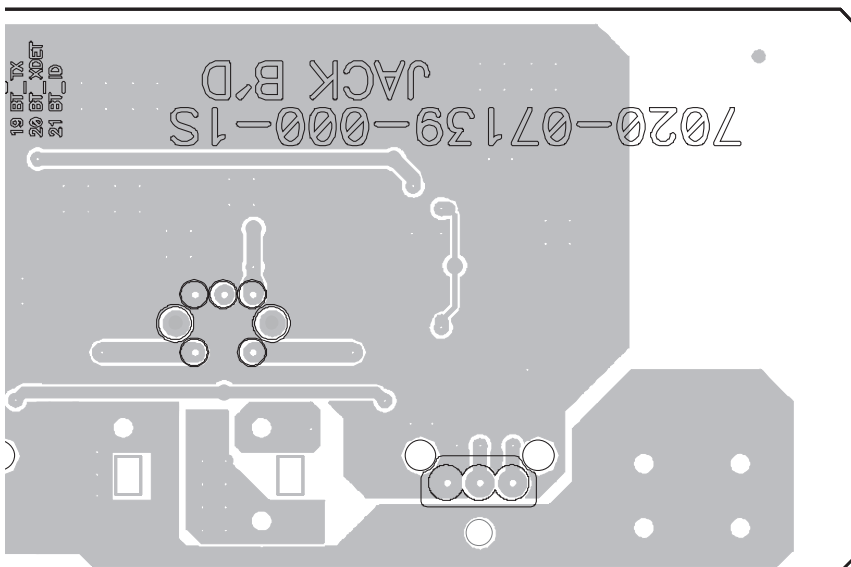

**NOTE FOR PCB DIAGRAMS :**

1. The parts mounted on this PCB include all necessary parts for several destinations. For further information for respective destinations, be sure to check with the schematic diagram.
2. View point of PCB diagrams.

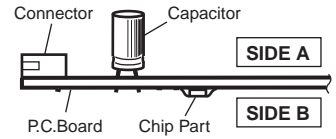

# 11.2 D-MAIN ASSY

**SIDE A**

**B** D-MAIN ASSY

IC	IC3031	IC3029	IC3012	IC2002	IC3011	IC2521	IC2003	IC2508	IC2507	IC3002	IC2004	IC2520	IC2505	IC2523	IC1002	IC2501	IC2515	IC2516
Q	Q1001	Q3003	Q3011	Q3009	Q3010	Q3001	Q3006	Q2501	Q2506	Q2509	Q2508							

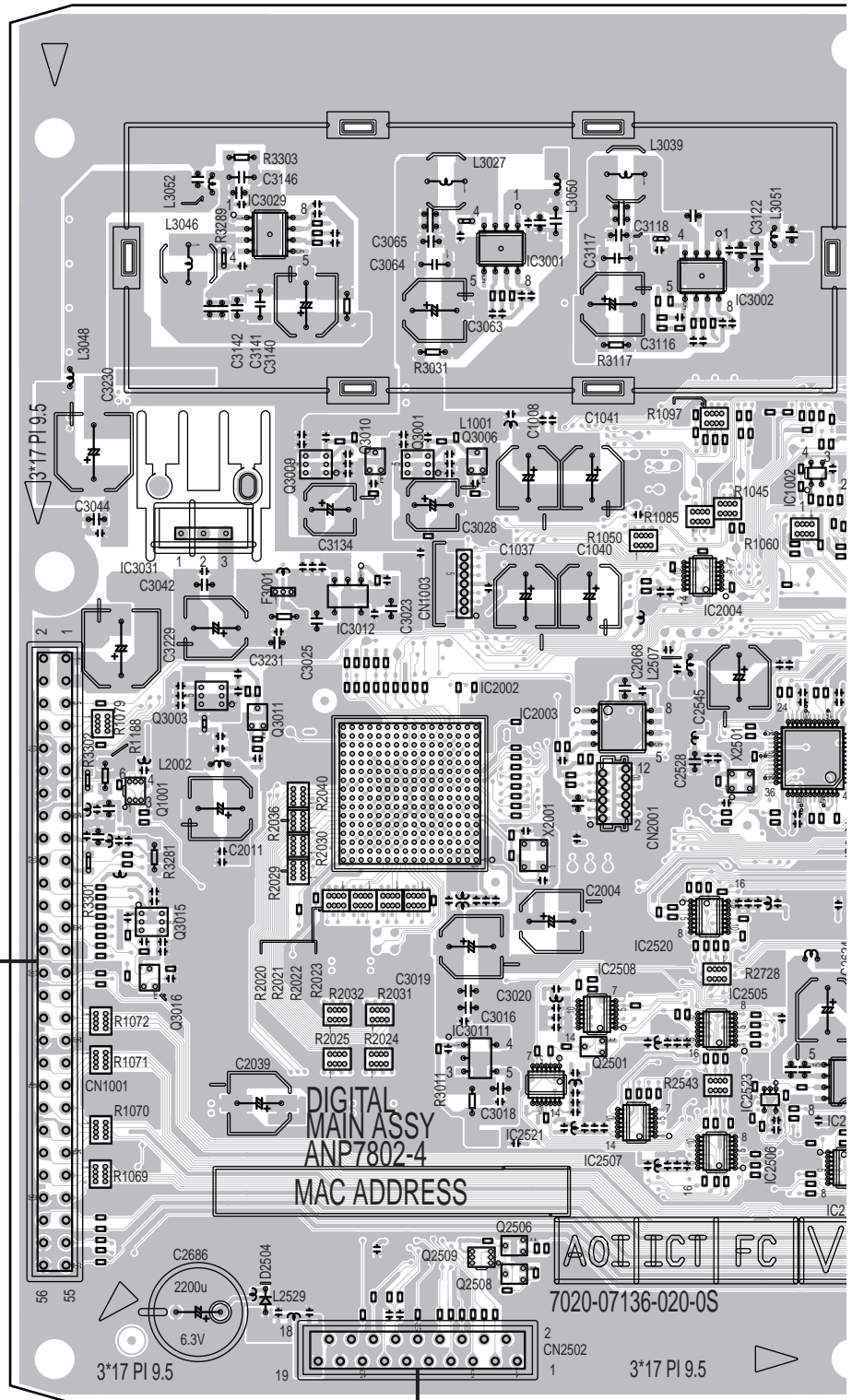

**L** CN702

CN1001

DIGITAL MAIN ASSY  
ANP7802-4  
MAC ADDRESS

AOICT FC  
720-07136-020-0S

CN2502

**C** CP500

N-50

**B**



SIDE A

A  
B  
C  
D  
E  
F

C3002	IC1002		IC2512	IC2503	
C2004	IC2501	IC1508	IC2509	IC2513	IC1502
IC2520	IC2515	IC1504	IC2519	IC2519	IC1506
IC2505	IC2523			IC1501	
IC2506	IC2516			IC1505	IC1503

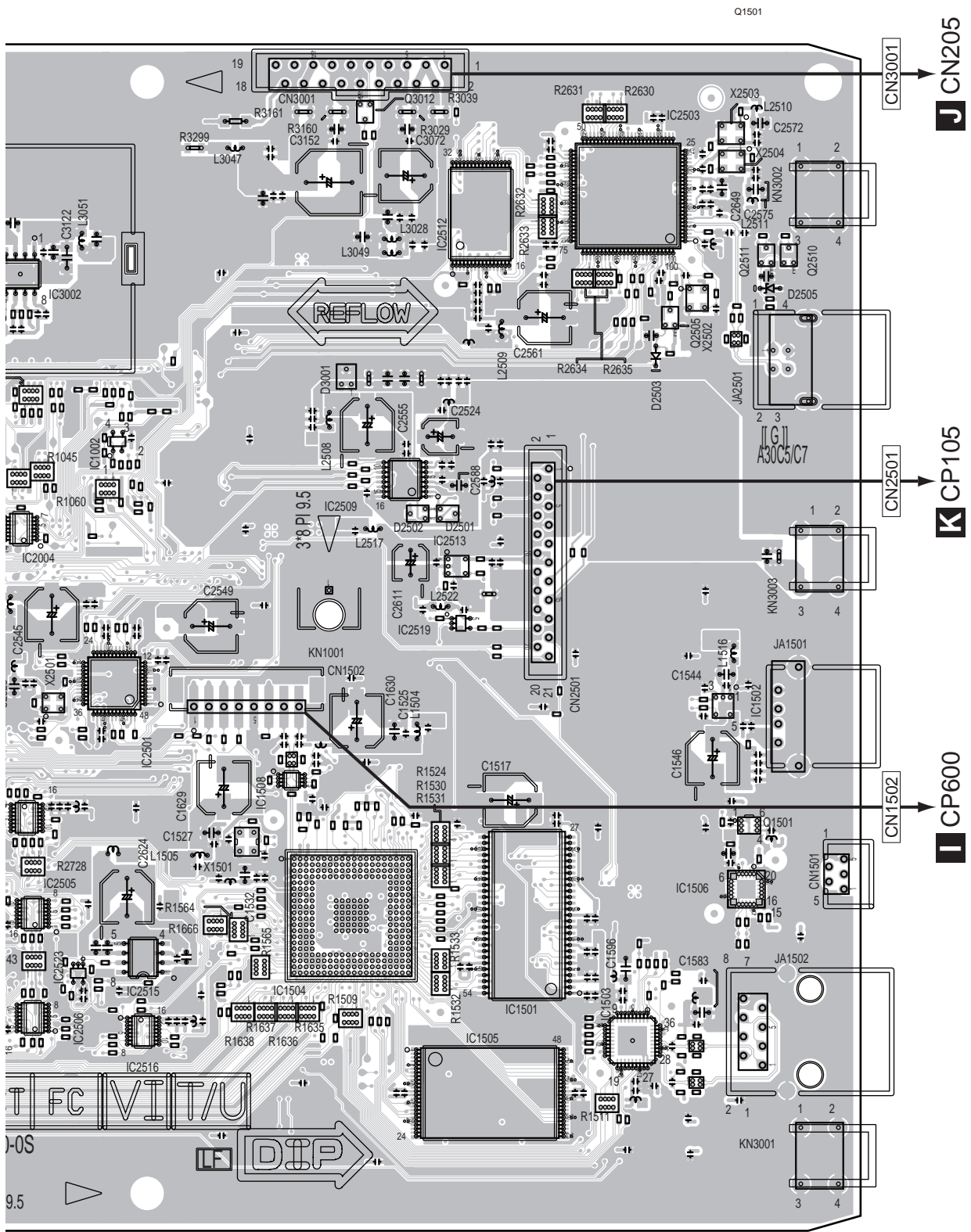

**SIDE B**

A

**B** D-MAIN ASSY

B

C

D

E

F

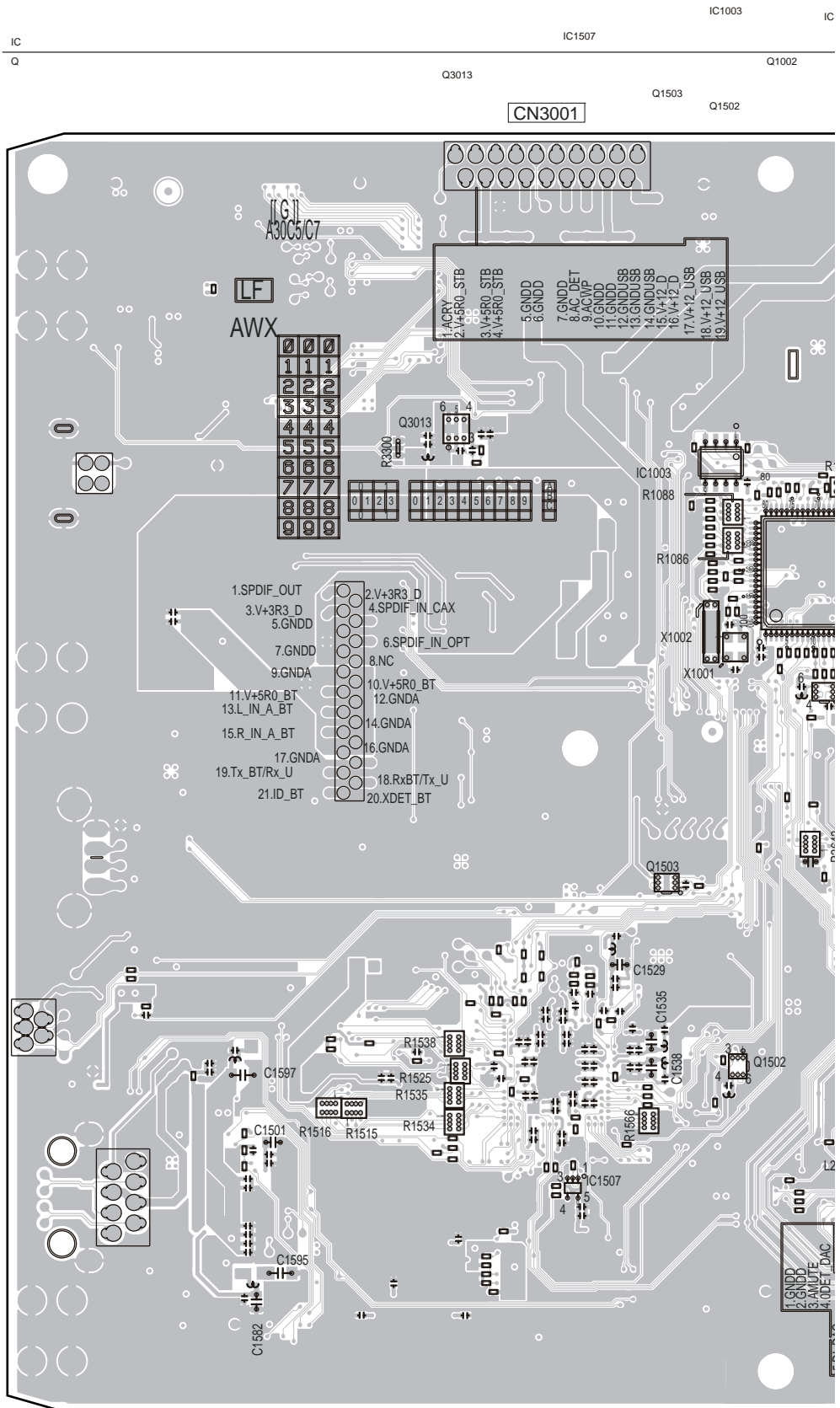

SIDE B

A

B

C

D

E

F

B

IC1003 IC1001 IC2005 IC2522 IC2001

Q1002 Q2001

Q1502 Q2504 Q2503

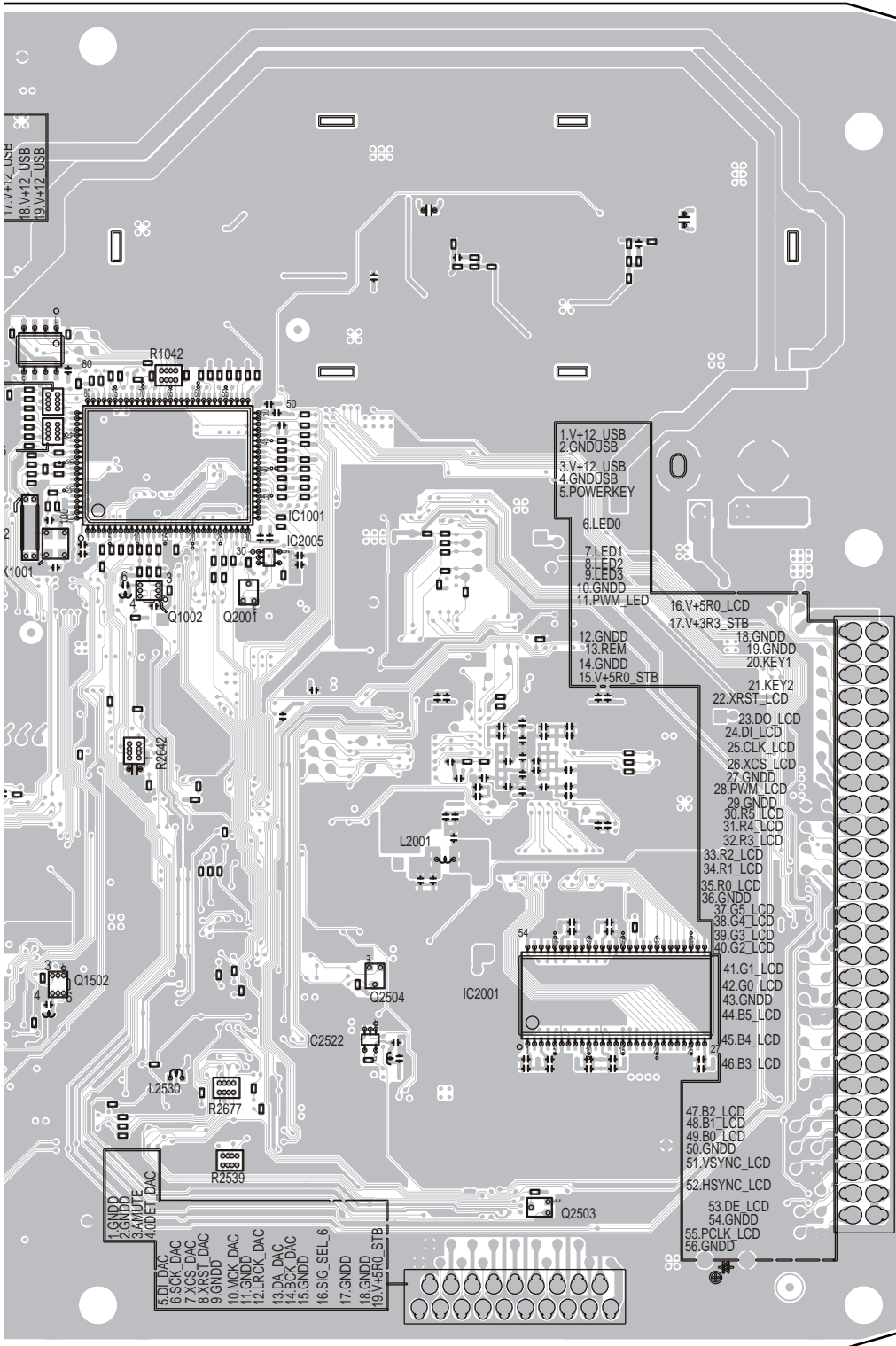

CN2502

N-50

# 11.3 DAC ASSY

**SIDE A**

## **C** DAC ASSY

**B** CN2502

FROM TRANS  
(FOR ANALOG)

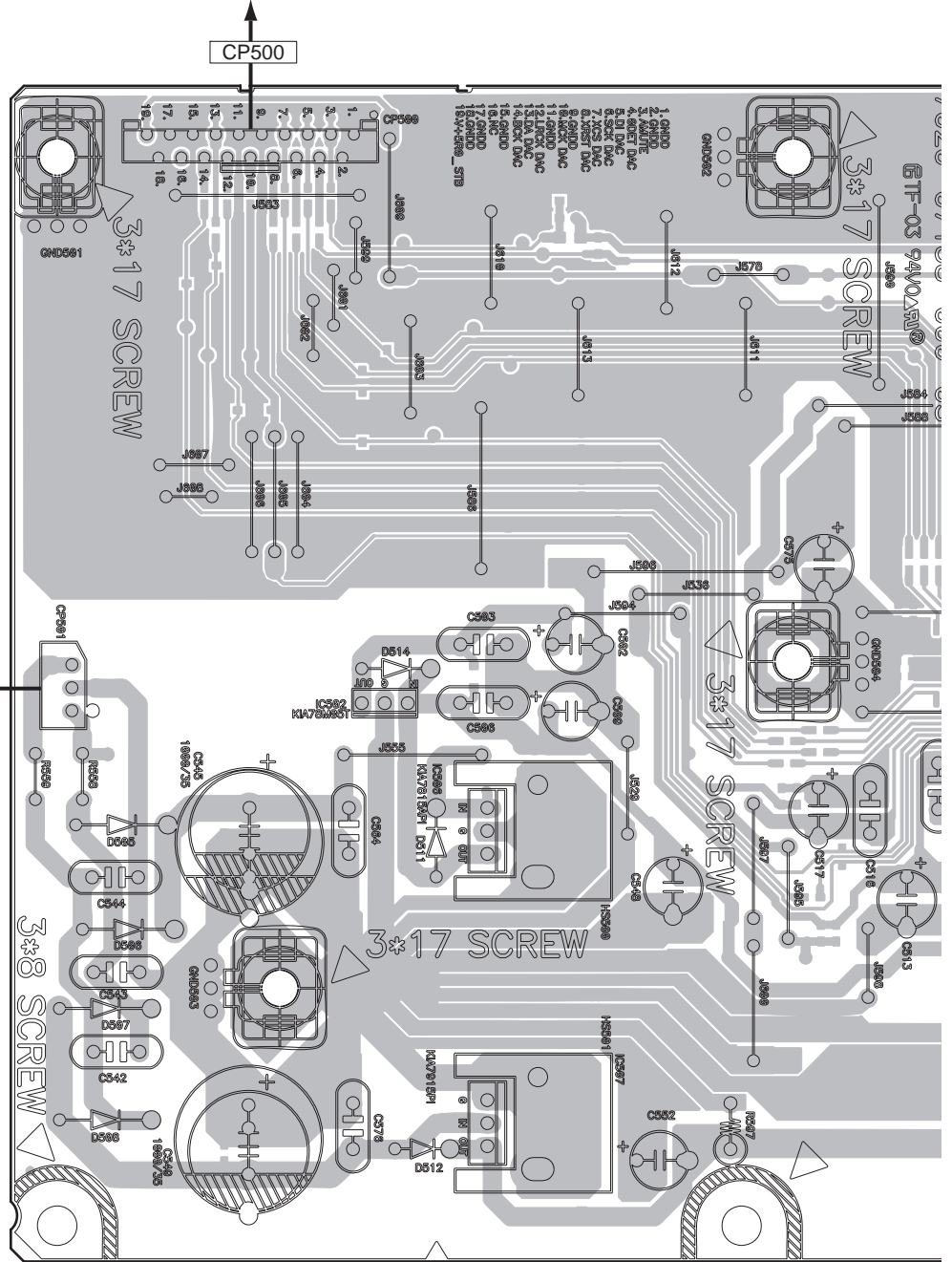

SIDE A

A

B

C

D

E

F

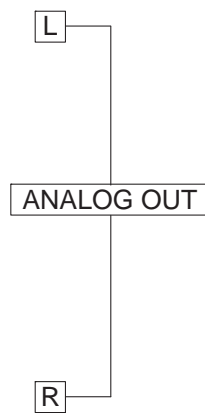
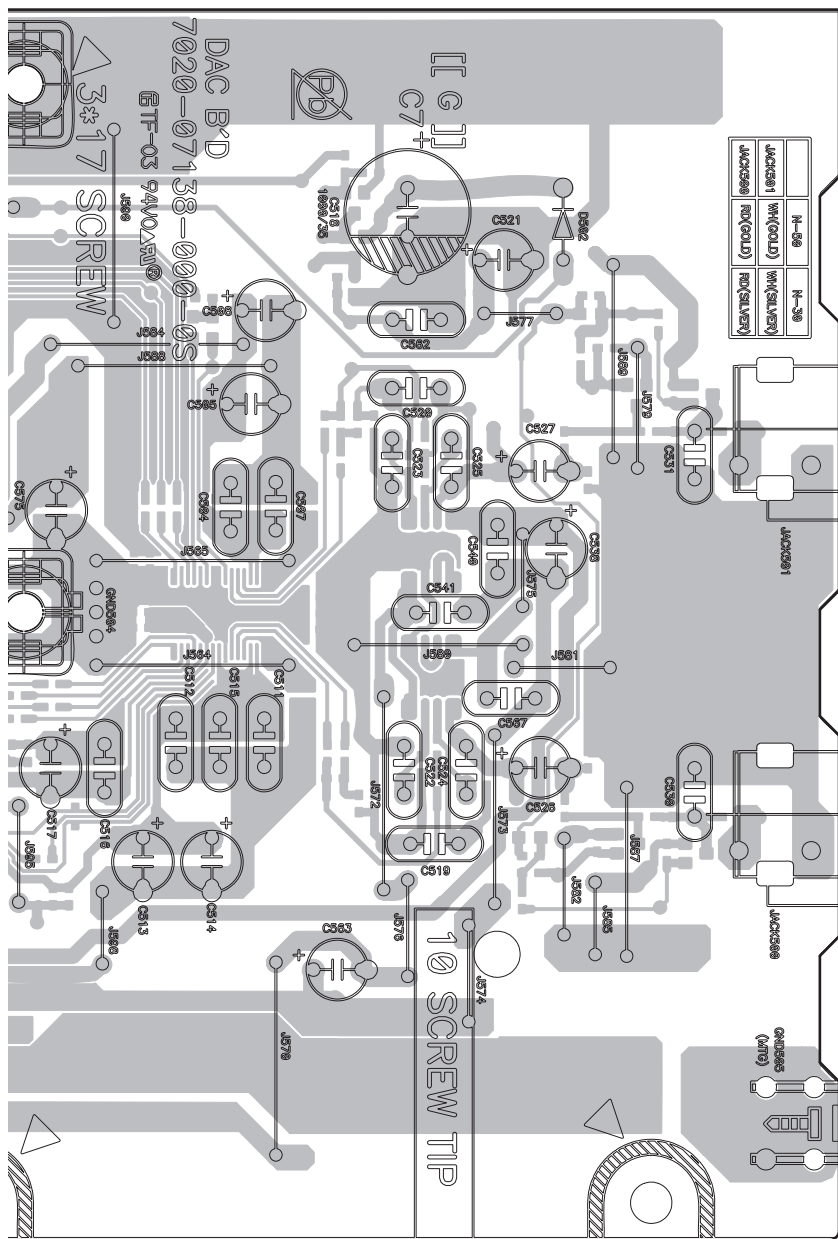

**SIDE B**

A

**C** DAC ASSY

B

C

D

E

F

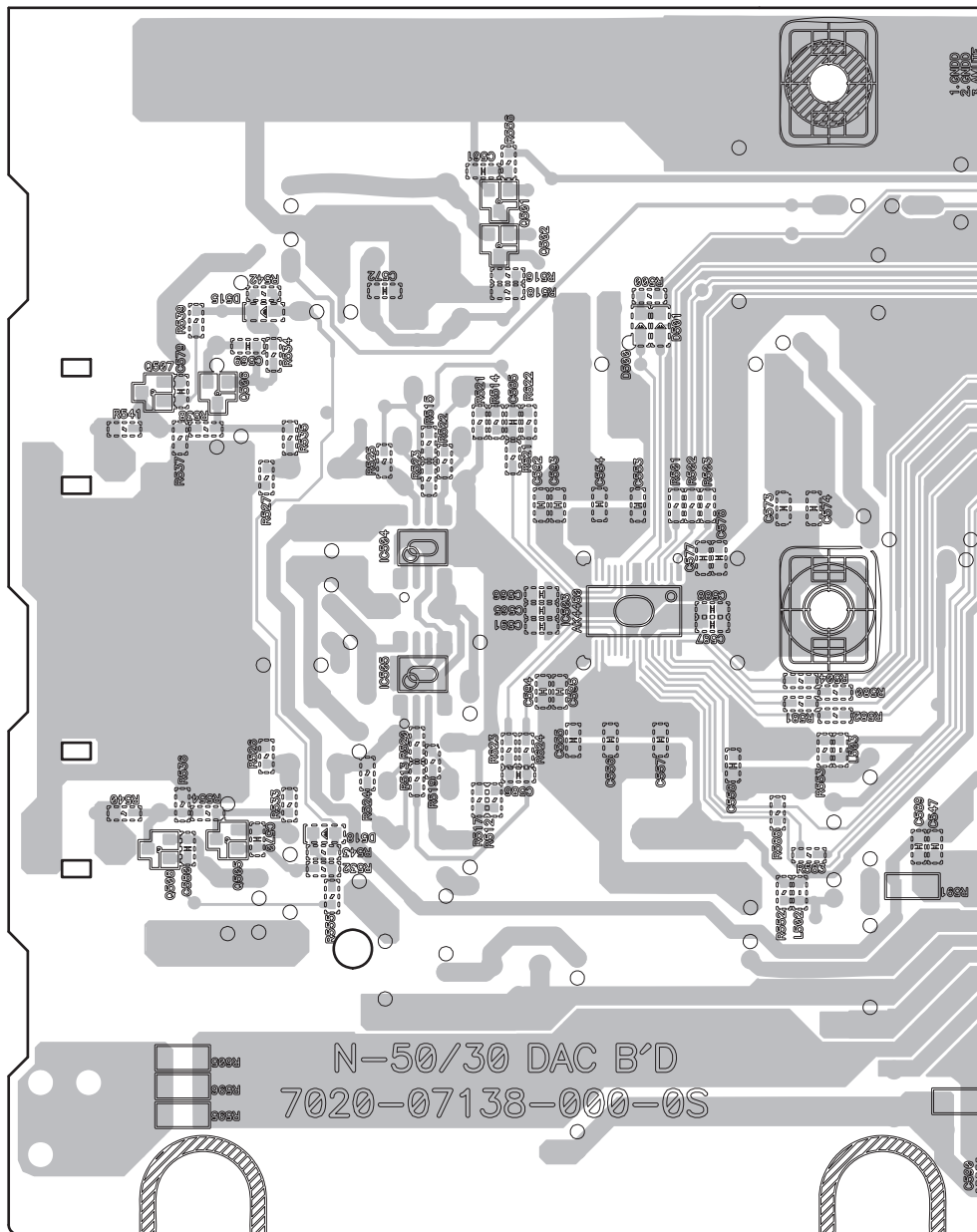

**C**

N-50

SIDE B

A

B

C

D

E

F

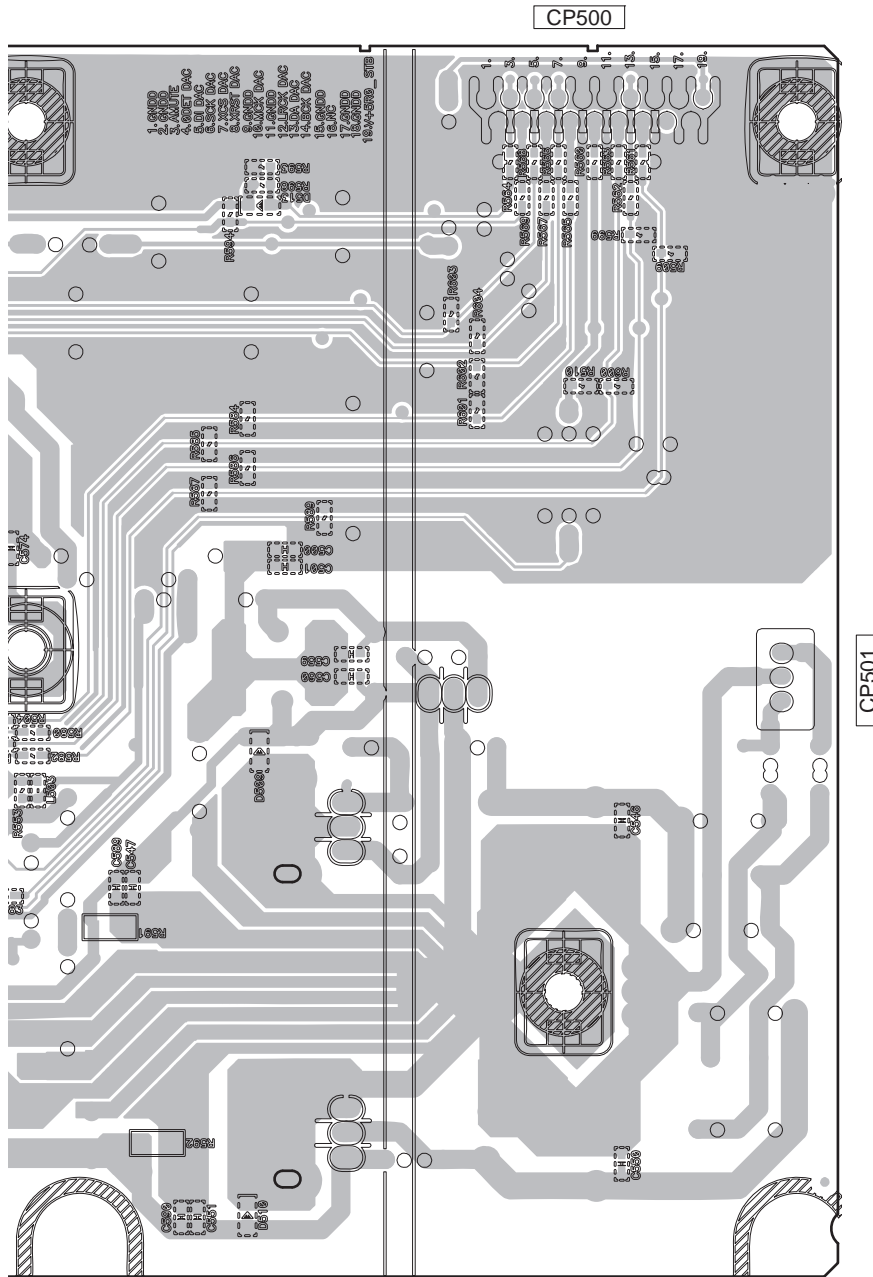

# 11.4 LCD/KEY ASSY

**SIDE A**

## **D** LCD/KEY ASSY

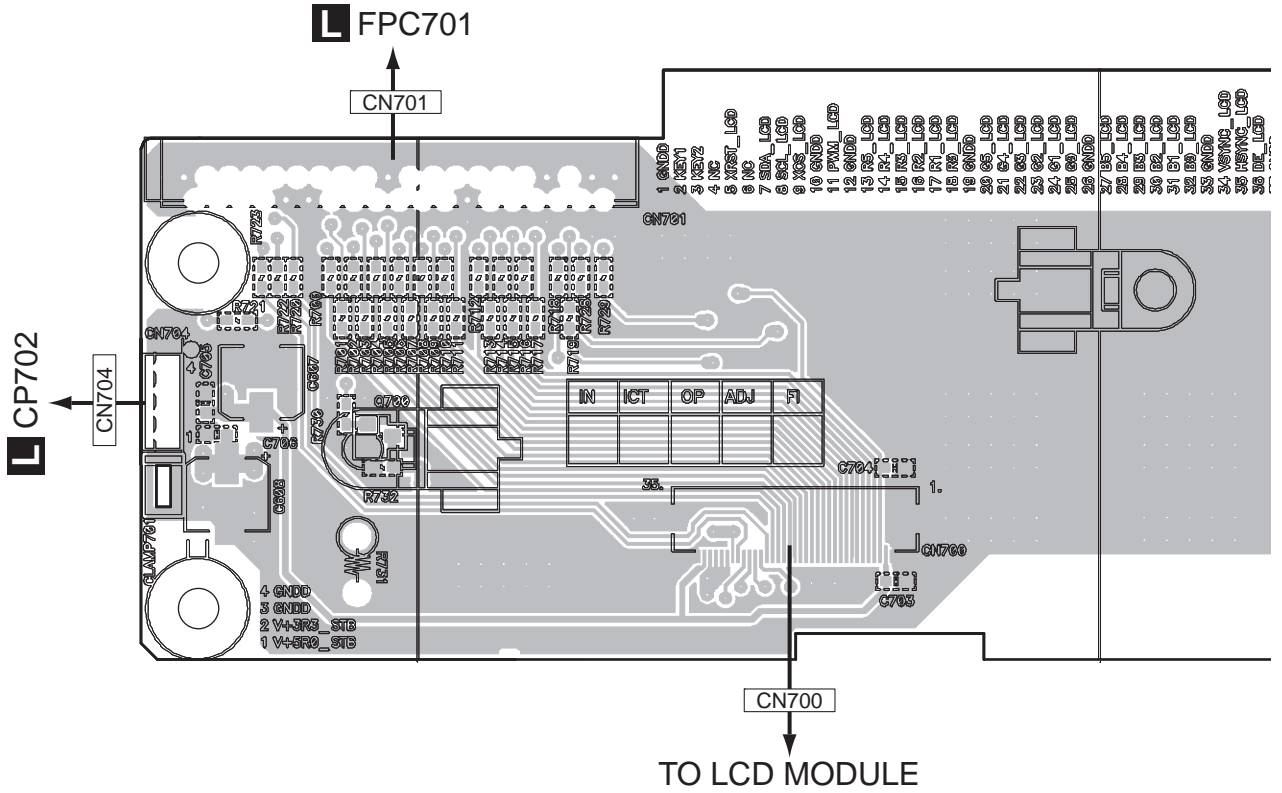

**SIDE B**

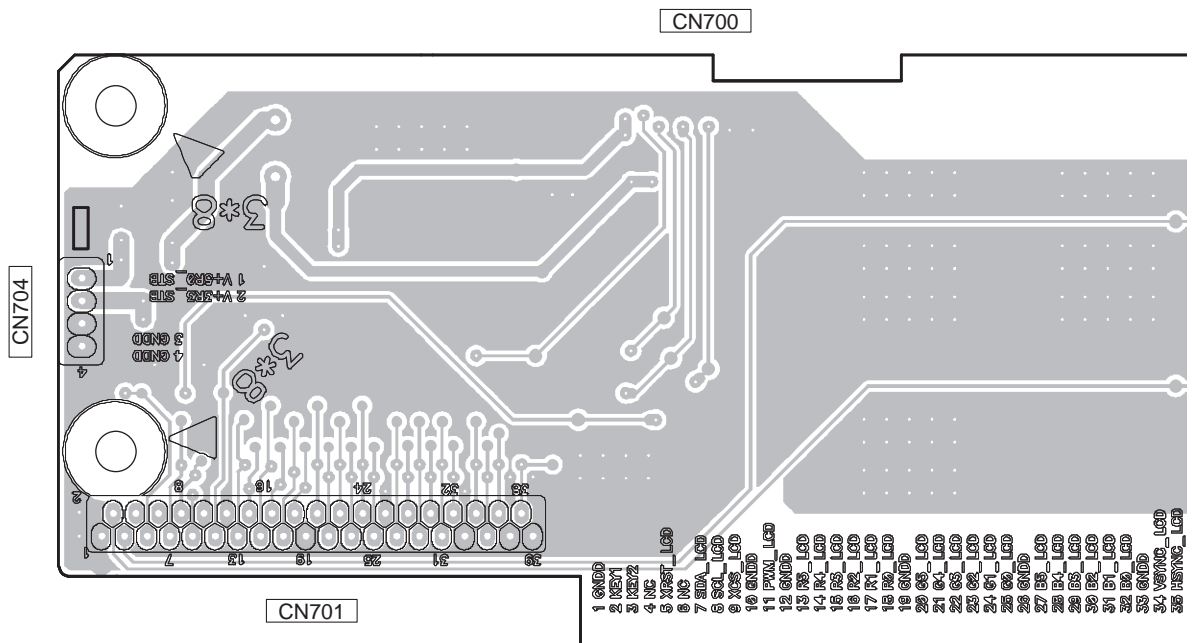

**D**



SIDE A

A

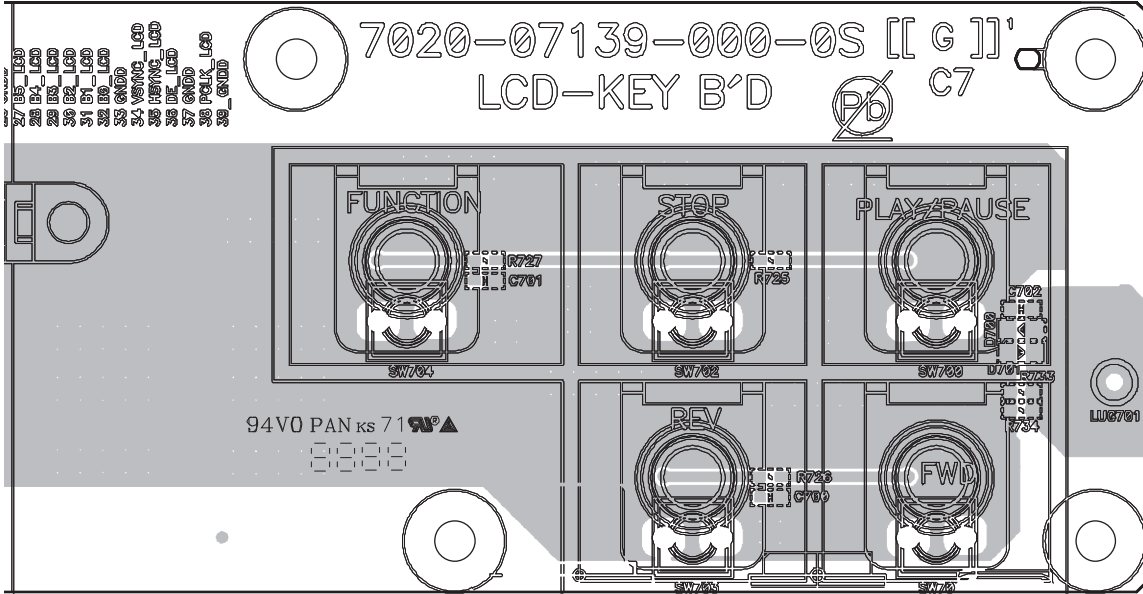

B

C

SIDE B

D

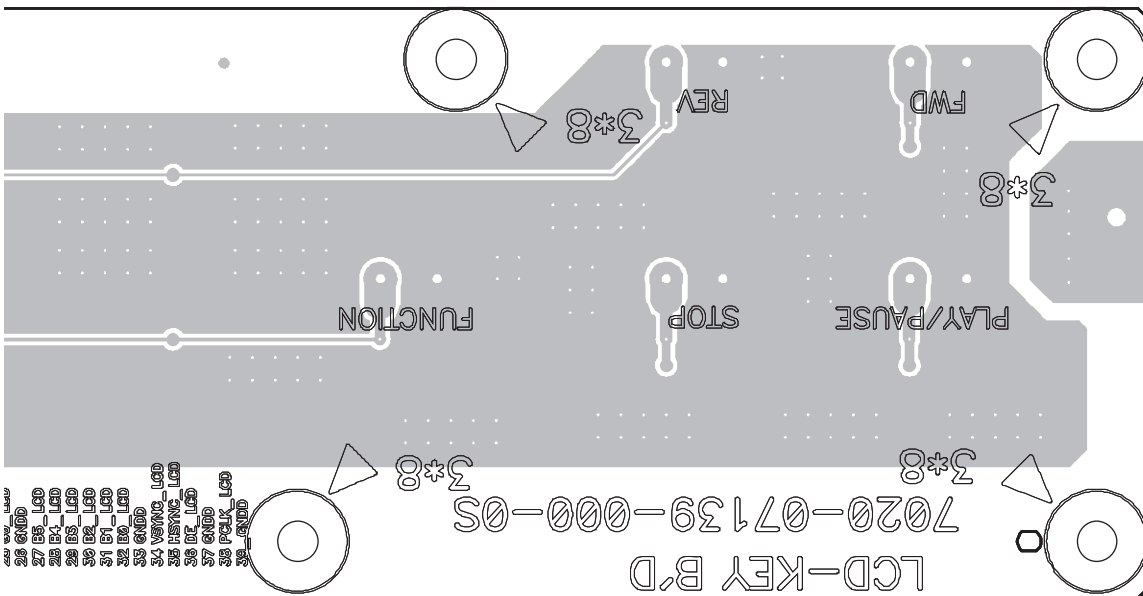

E

F



# 11.5 LED ASSY, POWER SW ASSY, IR ASSY AND POWER LED ASSY

SIDE A

SIDE A

## E LED ASSY

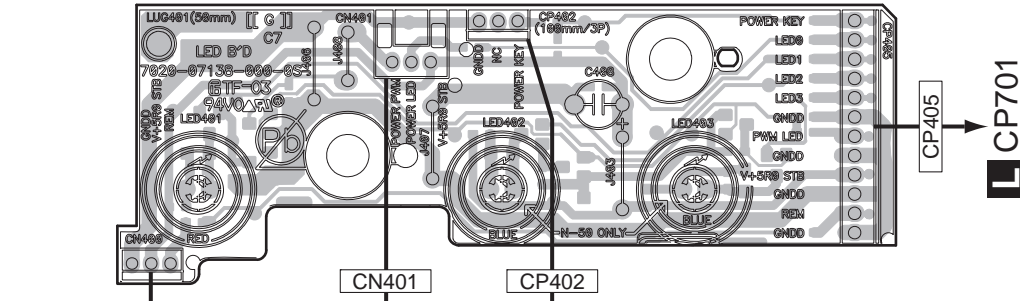

## F POWER SW ASSY

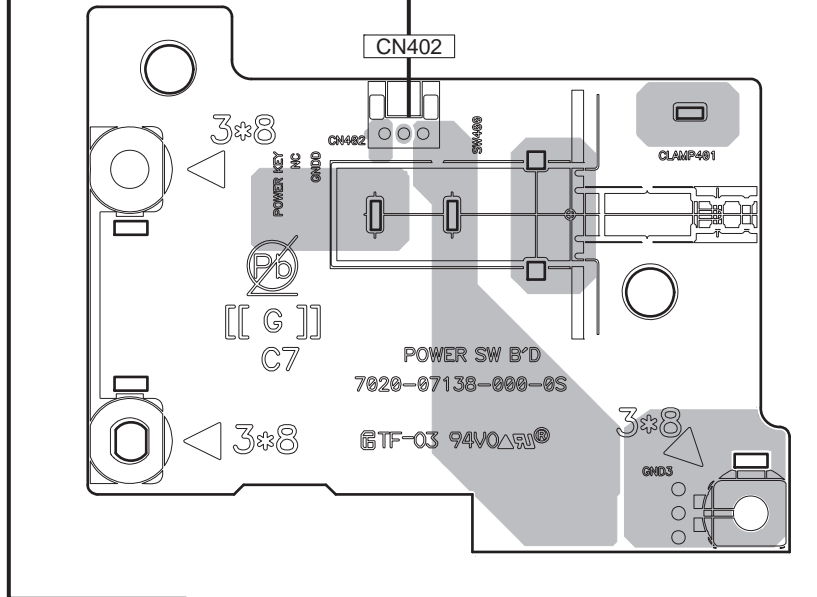

## G IR ASSY

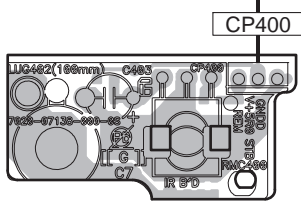

## H POWER LED ASSY

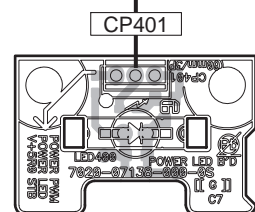

**E F G H**

**E F G H**

SIDE B

SIDE B

### E LED ASSY

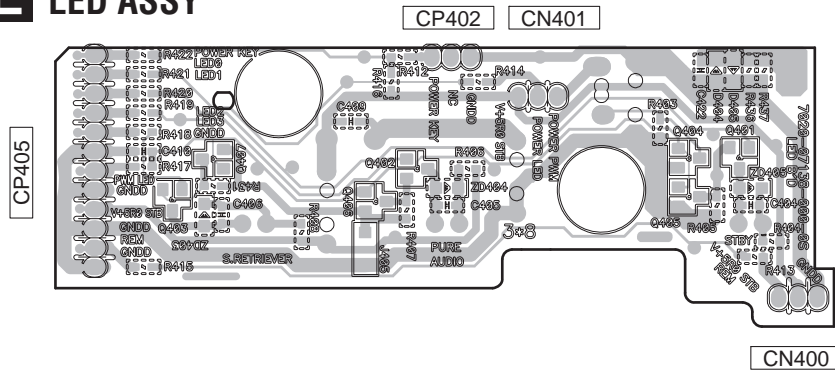

### F POWER SW ASSY

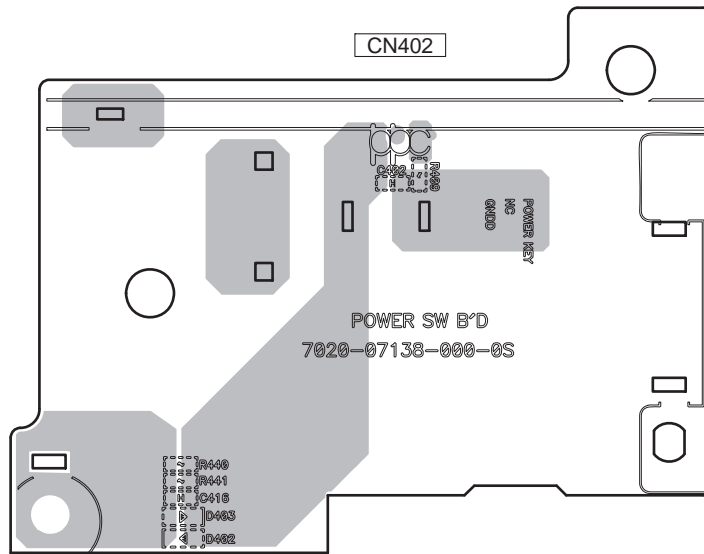

### H POWER LED ASSY

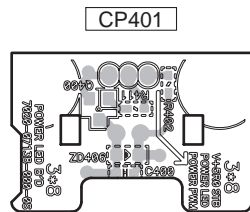

### G IR ASSY

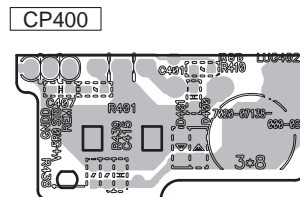

E F G H

E F G H

# 11.6 USB ASSY AND STBY ASSY

**SIDE A**

## **I** USB ASSY

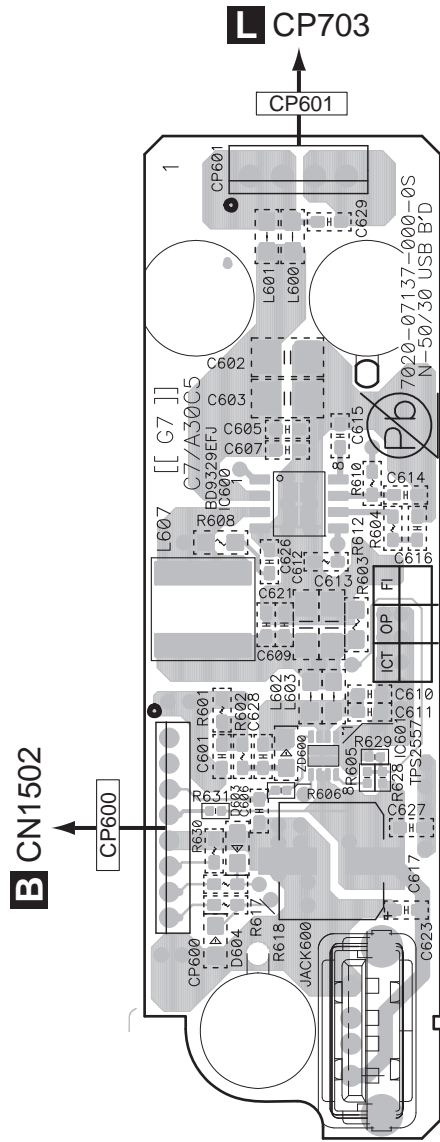

## **J** STBY ASSY

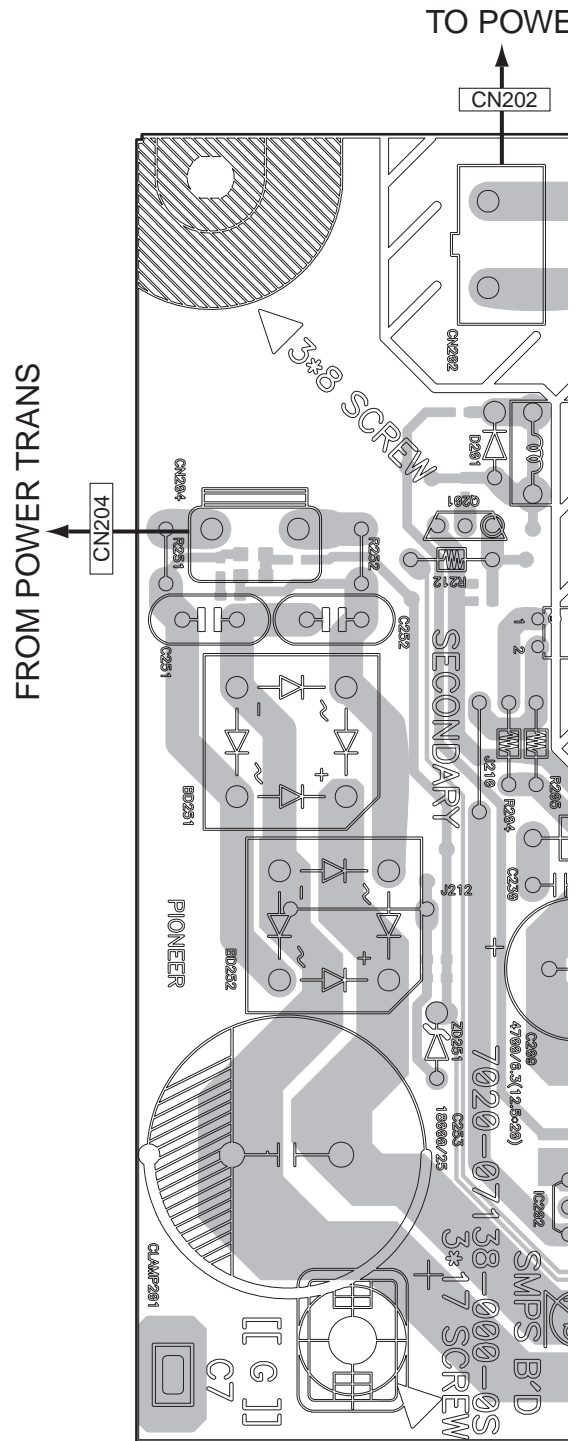

A  
B  
C  
D  
E  
F  
J

TO POWER TRANS

FROM AC INLET

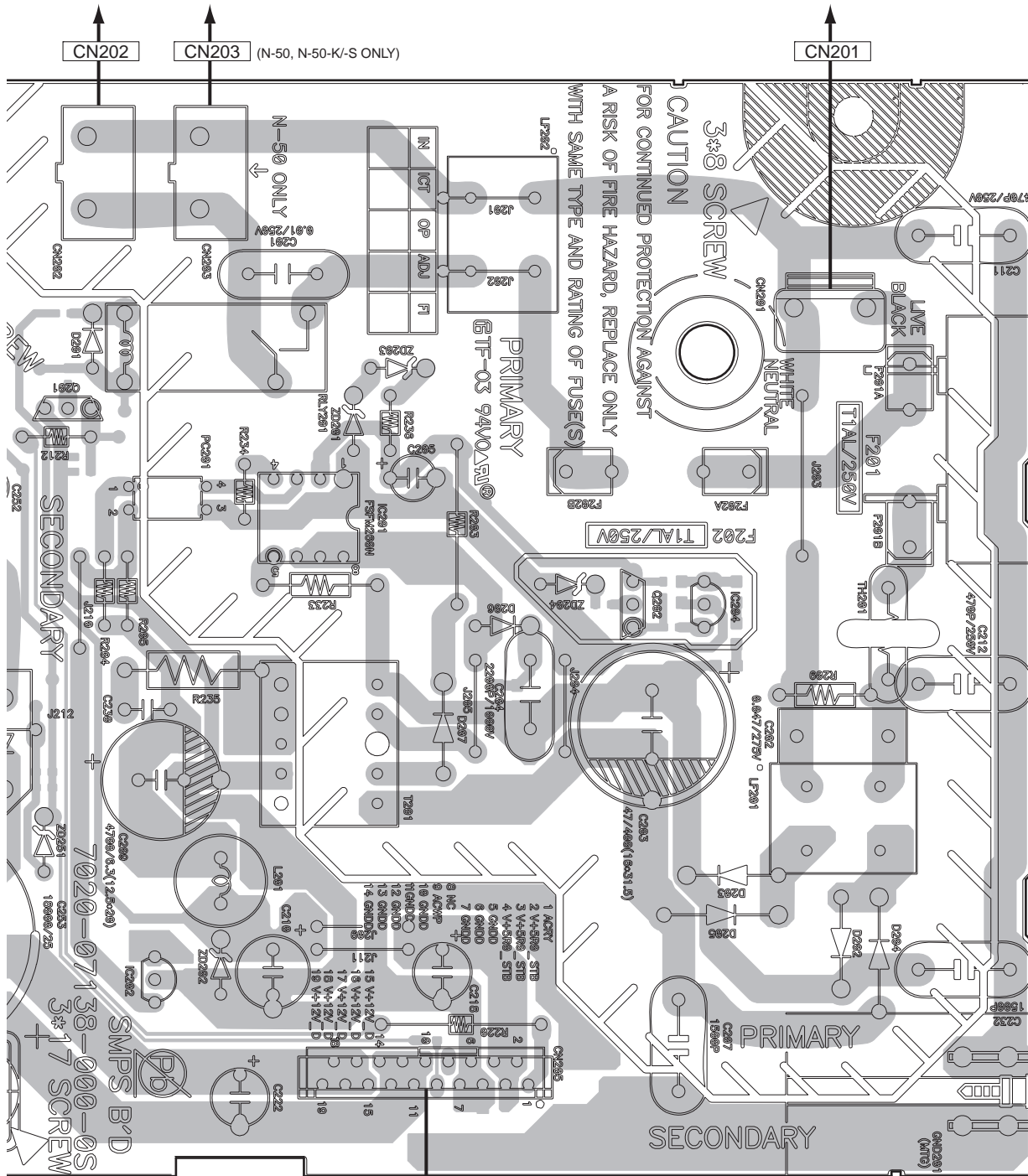

CN205  
B CN3001

SIDE B

A

# J STBY ASSY

B

C

D

E

F

CN201

CN203

CN20:

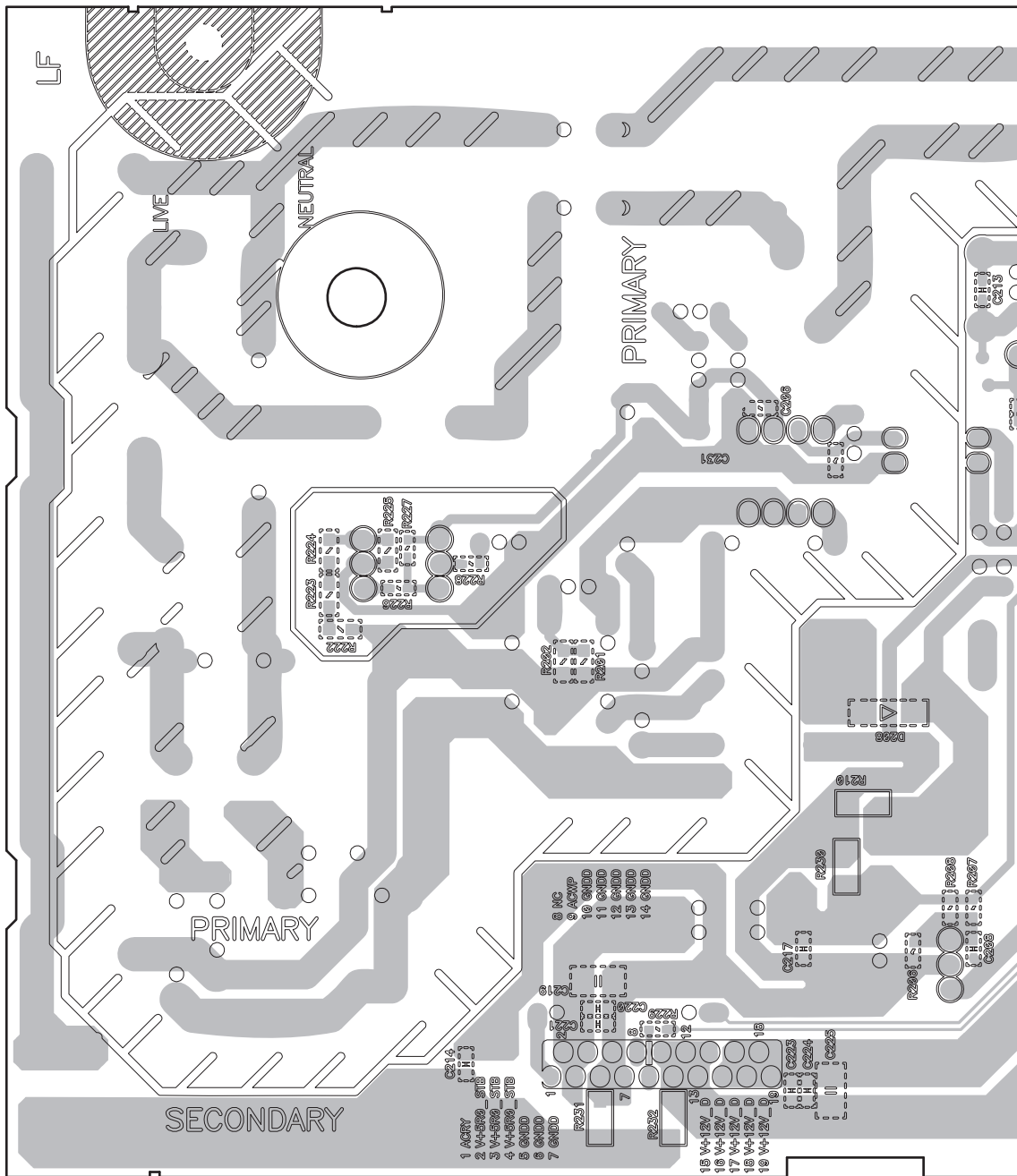

CN205

# J

N-50

SIDE B

A

B

C

D

E

F

# USB ASSY

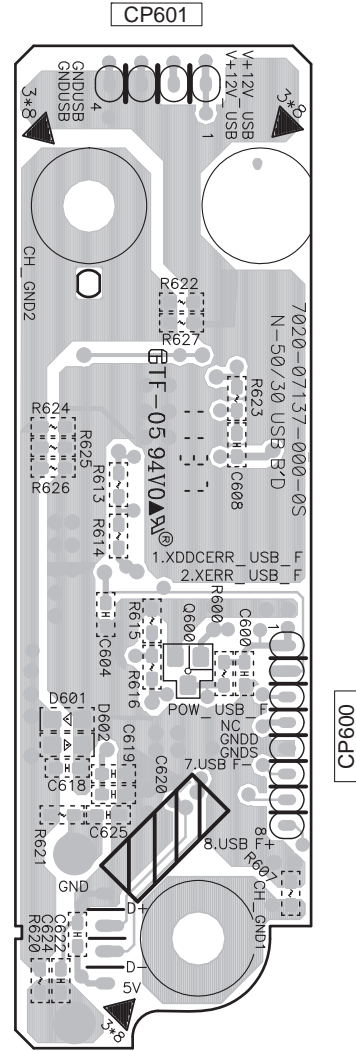
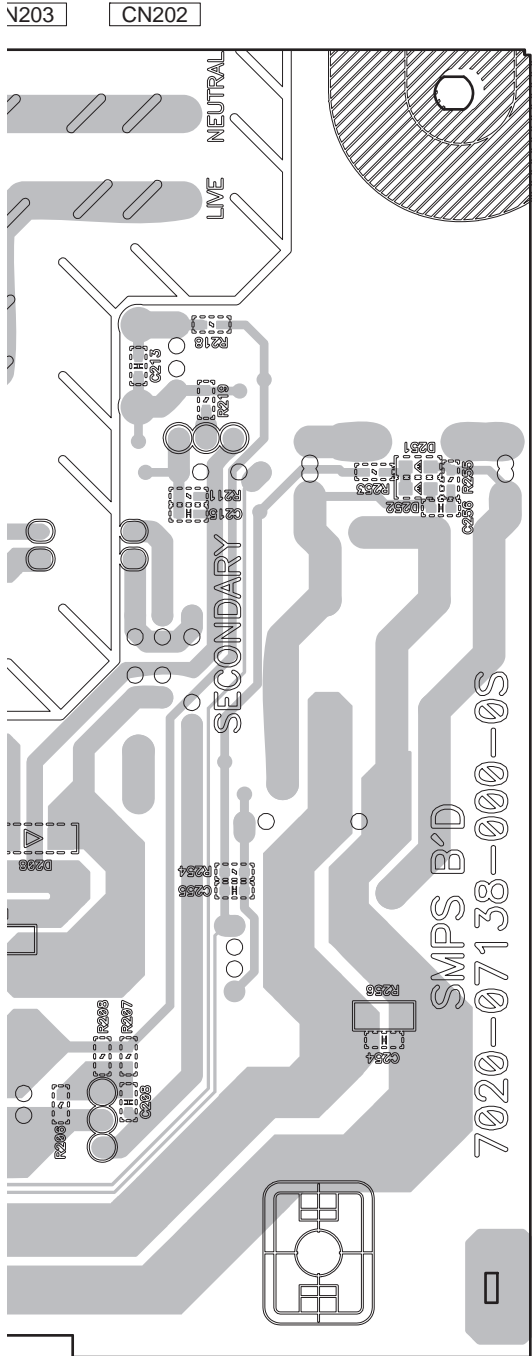

# 11.7 CNT A ASSY AND CNT B ASSY

SIDE A

SIDE A

## K CNT A ASSY

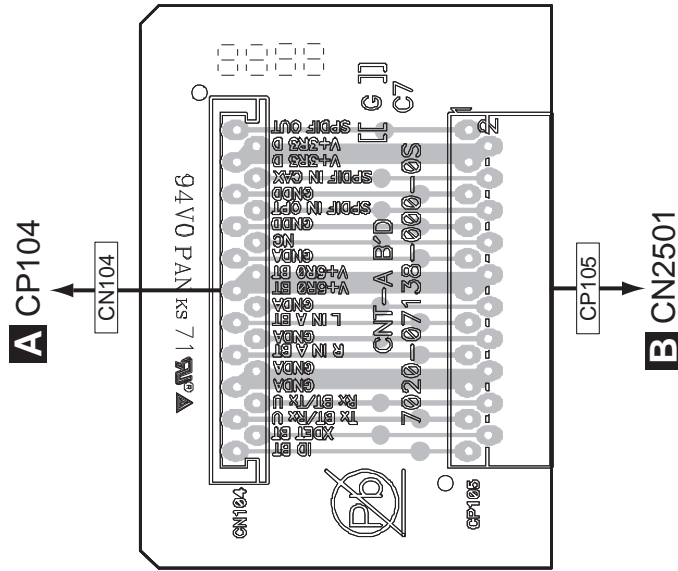

## L CNT B ASSY

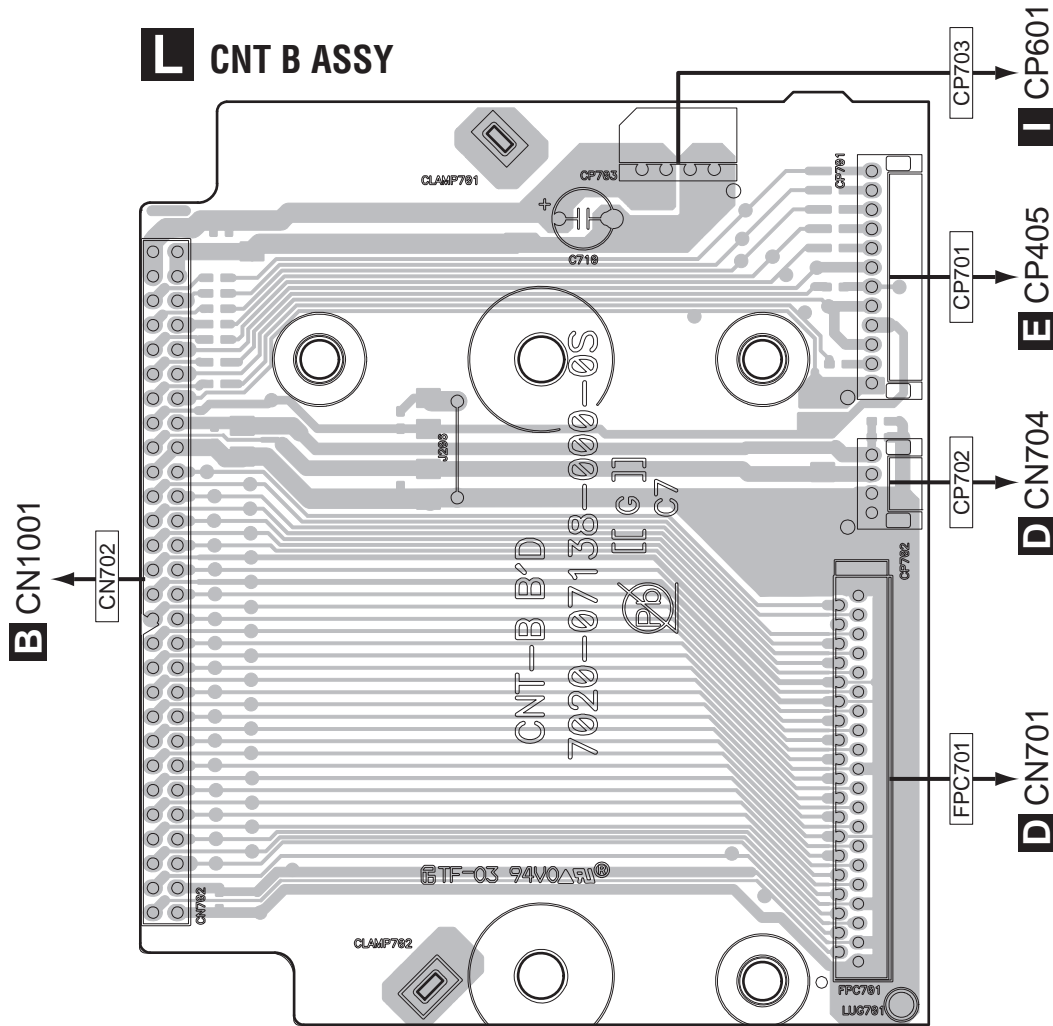

K L

K L



SIDE B

SIDE B

# K CNT A ASSY

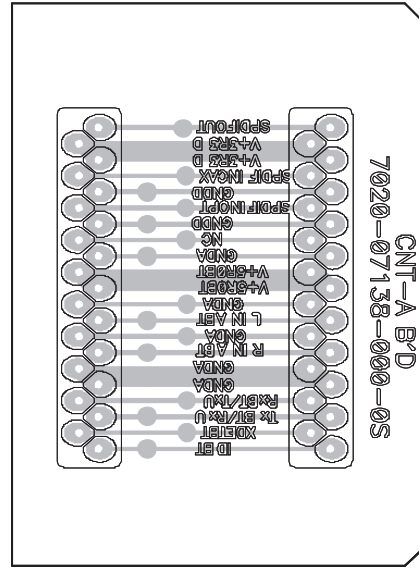

# L CNT B ASSY

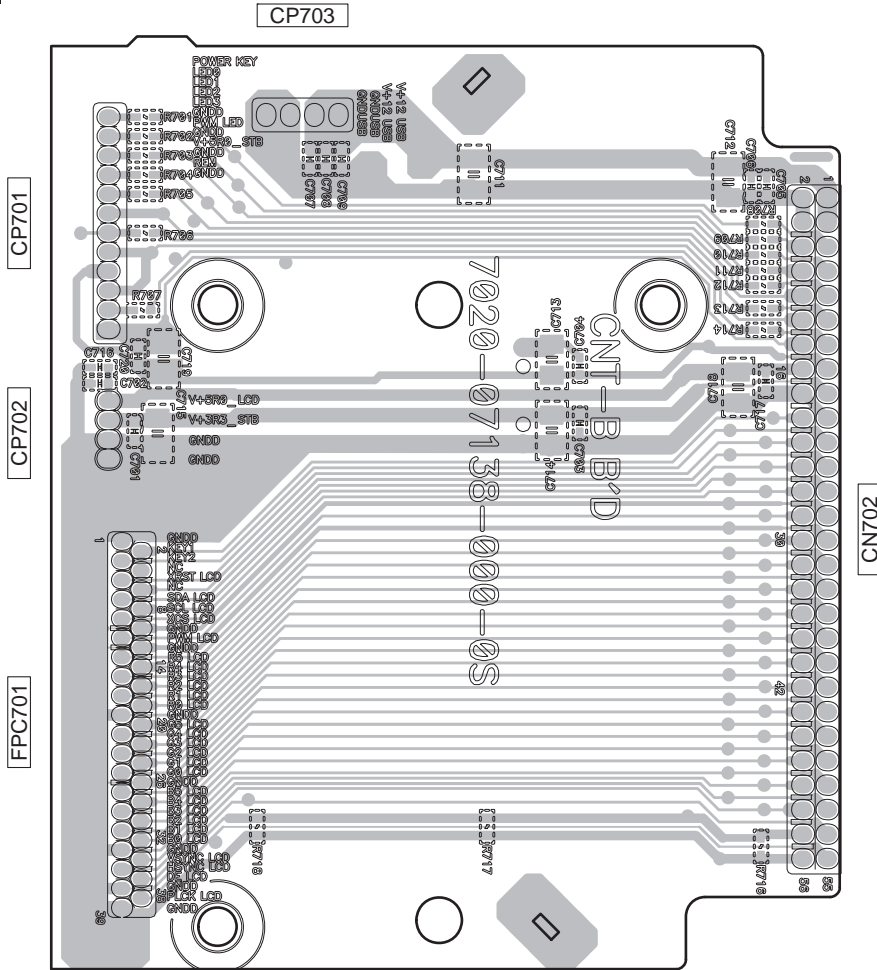

A  
B  
C  
D  
E  
F

K L

K L

11.8 GUIDE 1, GUIDE 2 (N-50, N-50-K/-S ONLY), GUIDE 3 AND GUIDE 4 ASSYS

SIDE A

SIDE A

**M** GUIDE 1 ASSY

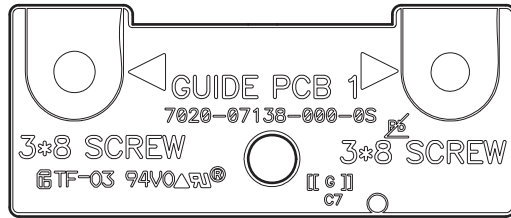

**N** GUIDE 2 ASSY

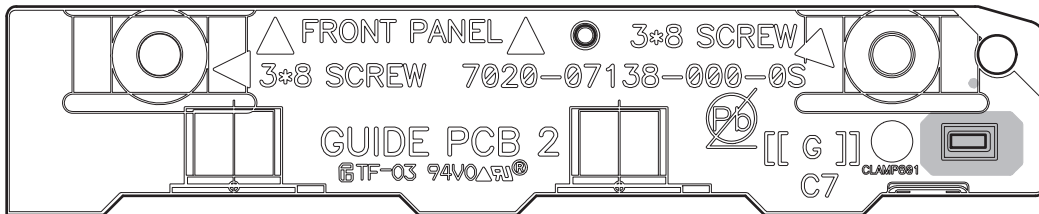

**O** GUIDE 3 ASSY

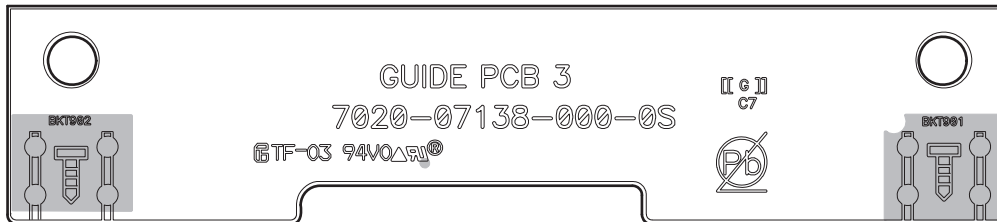

**P** GUIDE 4 ASSY

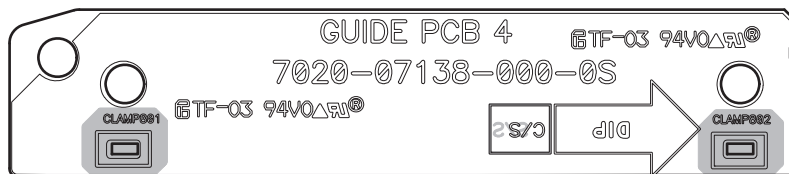

**M N O P**

**M N O P**

**SIDE B**

**SIDE B**

**M** GUIDE 1 ASSY

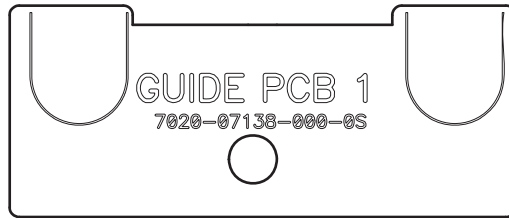

**N** GUIDE 2 ASSY

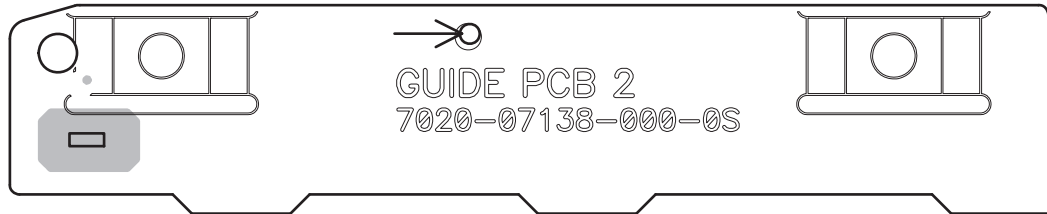

**O** GUIDE 3 ASSY

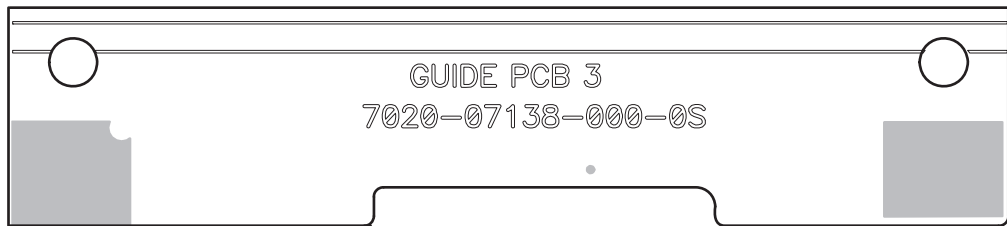

**P** GUIDE 4 ASSY



**M N O P**

**M N O P**

# 12. PCB PARTS LIST

NOTES: ● Parts marked by “NSP” are generally unavailable because they are not in our Master Spare Parts List.

● The ⚠ mark found on some component parts indicates the importance of the safety factor of the part. Therefore, when replacing, be sure to use parts of identical designation.

● When ordering resistors, first convert resistance values into code form as shown in the following examples.

Ex.1 When there are 2 effective digits (any digit apart from 0), such as 560 ohm and 47 k ohm (tolerance is shown by J = 5%, and K = 10%).

560 Ω → 56 × 10<sup>1</sup> → 561 ..... RD1/APU 5 6 7 J

47 kΩ → 47 × 10<sup>3</sup> → 473 ..... RD1/APU 4 7 3 J

0.5 Ω → R50 ..... RN2H R 5 0 K

1 Ω → 1R0 ..... RSIP 1 R 0 K

Ex.2 When there are 3 effective digits (such as in high precision metal film resistors).

5.62 kΩ → 562 × 10<sup>1</sup> → 5621 ..... RN1/4PC 5 6 2 1 F

Mark No.	Description	Part No.	Mark No.	Description	Part No.
<b>LIST OF ASSEMBLIES</b>			NSP	1..TTL ASSY DAC(N-30)	7025HU1102032-IL
NSP	1..TTL ASSY D-MAIN(N-50)	7025HU1103040-IL		2..GUIDE 4 ASSY	702807138B010-IL
	2..D-MAIN ASSY	7028071361010-IL		2..DAC ASSY	7028071381020-IL
NSP	1..TTL ASSY D-MAIN(N-50-K/-S)	7025HU1103030-IL	⚠	2..STBY ASSY	7028071382030-IL
	2..D-MAIN ASSY	7028071361010-IL		2..LED ASSY	7028071383020-IL
NSP	1.. TTL ASSY D-MAIN(N-30)	7025HU1102030-IL		2..POWER LED ASSY	7028071384010-IL
	2..D-MAIN ASSY	7028071361020-IL		2..POWER SW ASSY	7028071385010-IL
NSP	1..TTL ASSY D-MAIN(N-30-K/-S)	7025HU1102040-IL		2..IR ASSY	7028071386010-IL
	2..D-MAIN ASSY	7028071361020-IL		2..GUIDE 3 ASSY	7028071387010-IL
NSP	1..TTL ASSY D-MAIN(N-30-K/-S)	7025HU1102040-IL		2..CNT B ASSY	7028071388010-IL
	2..D-MAIN ASSY	7028071361020-IL		2..GUIDE 1 ASSY	7028071389010-IL
NSP	1..TTL ASSY USB(N-50)	7025HU1103041-IL	NSP	1..TTL ASSY DAC(N-30-K/-S)	7025HU1102042-IL
	2..USB ASSY	7028071371010-IL		2..GUIDE 4 ASSY	702807138B010-IL
NSP	1..TTL ASSY USB(N-50-K/-S)	7025HU1103031-IL	⚠	2..DAC ASSY	7028071381020-IL
	2..USB ASSY	7028071371010-IL		2..STBY ASSY	7028071382040-IL
NSP	1..TTL ASSY USB(N-30)	7025HU1102031-IL		2..LED ASSY	7028071383020-IL
	2..USB ASSY	7028071371010-IL		2..POWER LED ASSY	7028071384010-IL
NSP	1..TTL ASSY USB(N-30-K/-S)	7025HU1102041-IL		2..POWER SW ASSY	7028071385010-IL
	2..USB ASSY	7028071371010-IL		2..IR ASSY	7028071386010-IL
NSP	1..TTL ASSY DAC(N-50)	7025HU1103042-IL		2..GUIDE 3 ASSY	7028071387010-IL
	2..GUIDE 2 ASSY	702807138A010-IL		2..CNT B ASSY	7028071388010-IL
	2..GUIDE 4 ASSY	702807138B010-IL		2..GUIDE 1 ASSY	7028071389010-IL
	2..DAC ASSY	7028071381010-IL	NSP	1..TTL ASSY JACK(N-50)	7025HU1103043-IL
⚠	2..STBY ASSY	7028071382010-IL		2..JACK ASSY	7028071391010-IL
	2..LED ASSY	7028071383010-IL		2..LCD/KEY ASSY	7028071392010-IL
	2..POWER LED ASSY	7028071384010-IL		2..CNT A ASSY	7028071393010-IL
	2..POWER SW ASSY	7028071385010-IL	NSP	1..TTL ASSY JACK(N-50-K/-S)	7025HU1103033-IL
	2..IR ASSY	7028071386010-IL		2..JACK ASSY	7028071391010-IL
	2..GUIDE 3 ASSY	7028071387010-IL		2..LCD/KEY ASSY	7028071392010-IL
	2..CNT B ASSY	7028071388010-IL		2..CNT A ASSY	7028071393010-IL
	2..GUIDE 1 ASSY	7028071389010-IL	NSP	1..TTL ASSY JACK(N-30)	7025HU1102033-IL
NSP	1..TTL ASSY DAC(N-50-K/-S)	7025HU1103032-IL		2..JACK ASSY	7028071391020-IL
	2..GUIDE 2 ASSY	702807138A010-IL		2..LCD/KEY ASSY	7028071392010-IL
	2..GUIDE 4 ASSY	702807138B010-IL		2..CNT A ASSY	7028071393010-IL
	2..DAC ASSY	7028071381010-IL	NSP	1..TTL ASSY JACK(N-30-K/-S)	7025HU1102043-IL
⚠	2..STBY ASSY	7028071382020-IL		2..JACK ASSY	7028071391020-IL
	2..LED ASSY	7028071383010-IL		2..LCD/KEY ASSY	7028071392010-IL
	2..POWER LED ASSY	7028071384010-IL		2..CNT A ASSY	7028071393010-IL
	2..POWER SW ASSY	7028071385010-IL			
	2..IR ASSY	7028071386010-IL			
	2..GUIDE 3 ASSY	7028071387010-IL			
	2..CNT B ASSY	7028071388010-IL			
	2..GUIDE 1 ASSY	7028071389010-IL			

## A JACK ASSY

7028071391010-IL and 7028071391020-IL are constructed the same except for the following:

Mark	Symbol and Description	7028071391010-IL	7028071391020-IL
	IC100	E100216500010-IL	Not used
	IC103	TC74VHCU04FT	Not used
	JA101 Ter,rca 1pin	G600117G03000-IL	Not used
	JA102 Pin Jack(1p)	G600107AGF00Y-IL	G600107A0000Y-IL

## B D-MAIN ASSY

7028071361010-IL and 7028071361020-IL are constructed the same except for the following:

Mark	Symbol and Description	7028071361010-IL	7028071361020-IL
	IC2003	8952N50000010-IL	Not used
	IC2004	TC74VHC126FK	Not used
	IC2005	TC7SH08FUS1	Not used
	IC2503	CM6631-K	Not used
	IC2506	TC74VHC157FK	Not used
	IC2507	TC74VHC126FK	Not used
	IC3011	S-1172B12-U5	Not used
	IC3029	BD9328EFJ	Not used
	Q2001	J522011400020-IL	Not used
	Q2505	2SA1576A(QR)	Not used
	Q3003	RTQ040P02	Not used
	Q3011	2SC4081(QR)	Not used
	L2001 Chip Bead	D340212561010-IL	Not used
	L2002 Chip Bead	D340212561010-IL	Not used
	L2509 Chip Bead	D340212561010-IL	Not used
	L3046 Coil,inductor	D310502061000-IL	Not used
	L3052 Chip Bead	D340212561010-IL	Not used
	JA2501 Cn,plug Contact	G480670680010-IL	Not used
	C2004	VCH1234	Not used
	C2011	VCH1234	Not used
	C2039	D050221081550-IL	Not used
	C2561	VCH1234	Not used
	C3019	D050221081550-IL	Not used
	C3140	VCH1234	Not used

## C DAC ASSY

7028071381010-IL and 7028071381020-IL are constructed the same except for the following:

Mark	Symbol and Description	7028071381010-IL	7028071381020-IL
	JA500 Ter,rca 1pin	G600117G05000-IL	G600117050000-IL
	JA501 Ter,rca 1pin	G600117G06000-IL	G600117060000-IL
	CN500 Cn.fpc 1.25mm	L131019100010-IL	Not used
	CN501 Connector(3p)	L102526700300-IL	Not used
	CN9500 Cn.fpc 1.25mm	Not used	L131019100010-IL
	CN9501 Connector(3p)	Not used	L102526700300-IL

## E LED ASSY

7028071383010-IL and 7028071383020-IL are constructed the same except for the following:

Mark	Symbol and Description	7028071383010-IL	7028071383020-IL
	Q402	J522010300210-IL	Not used
	Q403	J522010300210-IL	Not used
	Q406	J522010300210-IL	Not used
	Q407	J522010300210-IL	Not used
	D402	K500036001420-IL	Not used
	D403	K500036001420-IL	Not used

**J** STBY ASSY

7028071382010-IL, 7028071382020-IL, 7028071382030-IL and 7028071382040-IL are constructed the same except for the following:

Mark	Symbol and Description	7028071382010-IL	7028071382020-IL	7028071382030-IL	7028071382040-IL
	CN203 Cn.wafer 7.92mm	L108011430210-IL	L108011430210-IL	Not used	Not used

**Mark No. Description** \_\_\_\_\_ **Part No.** \_\_\_\_\_

**Mark No. Description** \_\_\_\_\_ **Part No.** \_\_\_\_\_

**A** JACK ASSY  
**SEMICONDUCTORS**

IC 100 E100216500010-IL  
IC 101 E100216500020-IL  
IC 103,104 TC74VHCU04FT

**MISCELLANEOUS**

JA 101 TER,RCA 1PIN G600117G03000-IL  
JA 102 PIN JACK(1P) G600107AGF00Y-IL  
T 101 COIL,CHOKE D300726100010-IL  
CN 103 CONNECTOR CKS5712  
CN 104 CN,WAFER L109012522110-IL

**B** D-MAIN ASSY  
**SEMICONDUCTORS**

IC 1001 8952N30000020-IL  
IC 1002 BU4828F  
⚠ IC 1502,2513 BD2226G  
IC 1503 LAN8700C-AEZG  
IC 1506 341S2164

IC 1508 TC7USB31FK  
IC 2003 8952N50000010-IL  
IC 2004,2507,2508,2521 TC74VHC126FK  
IC 2005,2519 TC7SH08FUS1  
IC 2501 AK4118AEQ

IC 2503 CM6631  
IC 2505,2506 TC74VHC157FK  
IC 2509 AK5358AET  
IC 2515 ICS87002BM-05  
IC 2522 TC7SH04FUS1

⚠ IC 3001,3002,3029 BD9328EFJ  
⚠ IC 3011 S-1172B12-U5  
⚠ IC 3012 S-1170B33UC-OTS  
⚠ IC 3031 J126780500110-IL  
Q 1001,1002,1501,1503 UMD2N

Q 2001,2501,2503,2504 J522011400020-IL  
Q 2505 2SA1576A  
Q 2508,3011,3016 2SC4081  
Q 2509 UMD2N  
Q 3001,3003,3009,3015 RTQ040P02

Q 3006,3010,3012 J522011400020-IL  
D 2501 DAP202U  
D 2502 DAN202U  
D 2504 1SS355

**MISCELLANEOUS**

L 1504,1505,1516,2001 CHIP BEAD D340212561010-IL  
L 2002,2507-2509,2517 CHIP BEAD D340212561010-IL  
L 2522,3050-3052 CHIP BEAD D340212561010-IL  
⚠ L 3027,3039,3046 COIL,INDUCTOR D310502061000-IL  
JA 1501 CN,PLUG CONTACT G480040400030-IL

JA 1502 JACK,MODULAR G4060RJ450120-IL  
JA 2501 CN,PLUG CONTACT G480670680010-IL  
CN 1001 CN,WAFER 2.5MM L102125425610-IL  
CN 1501 CN.FPC 1.0MM L130100150550-IL  
CN 1502 CN,WAFER 2.0MM L101200220810-IL  
CN 2501 CN,WAFER L109012512110-IL  
CN 2502 CN.FPC 1.25MM L131019000010-IL  
CN 3001 CN.FPC 1.25MM L131019100010-IL

**CAPACITORS**

C 1008,1037,1041,1546 D050101083660-IL  
C 1040,1629,1630,2004 VCH1234  
C 1517,2039,2549,2555 D050221081550-IL  
C 2011,2545,2561,3140 VCH1234  
C 2624,3231 D050101083660-IL  
C 2686 D040222081000-IL  
C 3019,3072 D050221081550-IL  
C 3152,3230 D050101085210-IL

**C** DAC ASSY  
**SEMICONDUCTORS**

IC 502 J126780500550-IL  
IC 503 AK4480EF  
IC 504,505 J121458000020-IL  
⚠ IC 506 KIA7815API  
⚠ IC 507 KIA7915PI

Q 501 J522010200210-IL  
Q 502 J520010200210-IL  
Q 505-508 J5232114K0010-IL  
D 500,501,509,510 K005041480030-IL  
D 502 K000013300520-IL  
⚠ D 505-508 K000400700010-IL

**MISCELLANEOUS**

JA 500 TER,RCA 1PIN G600117G05000-IL  
JA 501 TER,RCA 1PIN G600117G06000-IL  
CN 500 CN.FPC 1.25MM L131019100010-IL  
CN 501 CONNECTOR(3P) L102526700300-IL

**RESISTORS**

R 597 C060033166050-IL

**CAPACITORS**

C 503,504,506,507 D02010406C060-IL  
C 505,513,517 D040101084060-IL  
C 511,512,515,516 D02010406C060-IL  
C 518,545,549 D040102085030-IL  
C 519,520 D02039206C060-IL  
C 522-525 D02047106C060-IL  
C 530,531 D02033106C050-IL  
C 540-544 D02047306C060-IL

**Mark No. Description Part No.**

## **D** LCD/KEY ASSY

### **SEMICONDUCTORS**

Q 700 J522010300210-IL

### **MISCELLANEOUS**

S 700-704 SWITCH G180501000010-IL  
 CN700 CN.FPC 0.5MM L136050020350-IL  
 CN701 CN.FPC 1.0MM L130100113950-IL  
 CN704 CN.WIRE 2MM L002800042620-IL

### **RESISTORS**

R 731 C060027065050-IL

## **E** LED ASSY

### **SEMICONDUCTORS**

Q 401-404,406,407 J522010300210-IL  
 D 401 K500032001160-IL  
 D 402,403 K500036001420-IL

### **MISCELLANEOUS**

CN401 CN.WAFER 2.0MM L101200100320-IL

## **F** POWER SW ASSY

### **MISCELLANEOUS**

S 400 SW,PUSH G000122006060-IL  
 CN402 CN.WAFER 2.0MM L101200100320-IL

## **G** IR ASSY

### **SEMICONDUCTORS**

IC 400 E940349003810-IL

## **H** POWER LED ASSY

### **SEMICONDUCTORS**

Q 400 J522010300210-IL  
 D 400 K500036001420-IL

## **I** USB ASSY

### **SEMICONDUCTORS**

⚠ IC 600 BD9329EFJ  
 ⚠ IC 601 J046255700010-IL  
 ⚠ Q 600 J5223875Y0210-IL  
 D 600 K06605R64P400-IL

### **MISCELLANEOUS**

L 607 COIL,INDUCTOR D310804061000-IL  
 JA 600 CN,PLUG CONTACT G480040040040-IL

**Mark No. Description Part No.**

## **J** STBY ASSY

### **SEMICONDUCTORS**

IC 201 J040226010010-IL  
 IC 202 J126243118010-IL  
 Q 201 J5023198Y0000-IL  
 D 201 K000013300520-IL  
 ⚠ D 202-205 K040000100010-IL

D 206 K050000015000-IL  
 D 207 K000400700010-IL  
 ⚠ D 208 K125036000010-IL  
 D 251,252 K005041480030-IL  
 ⚠ D 7251,7252 K047604000020-IL

D 9201,9203 K06039R044520-IL  
 D 9202 K06006R844520-IL  
 D 9251 K06005R144520-IL  
 ⚠ TH 201 F340315005510-IL

### **MISCELLANEOUS**

⚠ L 201 COIL,LINE FILTER D320101405510-IL  
 ⚠ RY 201 RELAY G680050102020-IL  
 ⚠ T 201 TRANS,SWITCHING E060928705510-IL  
 ⚠ CN 201 CONNECTOR L108202000220-IL  
 ⚠ CN 202,203 CN.WAFER 7.92MM L108011430210-IL

CN 204 CONNECTOR L108202000220-IL  
 CN 205 CN.FPC 1.25MM L131019000010-IL  
 FU 201,202 FUSE GLASS TUBE 20MM N751501001160-IL  
 ⚠ PC 201 PHOTO,COUPLER K614817005510-IL

### **RESISTORS**

R 233 C060010465520-IL

### **CAPACITORS**

⚠ C 202 D02147307H000-IL  
 C 205 D04022008C070-IL  
 ⚠ C 207,232 D00815248H010-IL  
 C 210 D040471081070-IL  
 ⚠ C 211 D00847127H010-IL  
 C 212 D00847127H010-IL

## **K** CNT A ASSY

### **MISCELLANEOUS**

CN 104 CN,WAFER L109012512110-IL  
 CN 105 CN,WAFER L109012522110-IL

## **L** CNT B ASSY

### **MISCELLANEOUS**

CN 702 CN.WAFER 2.5MM L102225425610-IL  
 CN 8701 CN.FPC 1.0MM L130100113950-IL  
 CN 9701 CN.WAFER 2.0MM L101200101220-IL  
 CN 9702 CN.WAFER 2.0MM L101200100420-IL  
 CN 9703 CN.WAFER 2.5MM L102526800400-IL

## **M** GUIDE 1 ASSY

GUIDE 1 ASSY has no service parts.

**Mark No. Description** \_\_\_\_\_ **Part No.** \_\_\_\_\_

**N GUIDE 2 ASSY**

GUIDE 2 ASSY has no service parts.

A

**O GUIDE 3 ASSY**

GUIDE 3 ASSY has no service parts.

**P GUIDE 4 ASSY**

GUIDE 4 ASSY has no service parts.

B

C

D

E

F