

PRODUCT No.23900

ASAHI PENTAX **MUE**

**SERVICE MANUAL** ENGLISH



## Disassembly Procedure

1. Self-timer charge lever assembly (0-A118)-Self-timer screw left-handed (A122)  
- 231K-H50
2. Body Covering, left and right (A19, A20)
3. Install self-timer lever assembly (0-A118) temporarily.
4. Bottom cover assembly (A400) - CSS 1.7 x 2.8 x 3  
Connector seat (A23), R button (C117)
5. Winding lever assembly (0-C69)  
Cover screw (C139) - 23600K-C135-A (left handed)  
Winding lever nut (C8) - 23600K-C134-A2  
Cover ring (A321)
6. Shutter dial  
Shutter dial at AUTO  
Loosen set screw (A319) - Shutter dial (A316)  
Release pin (A313) - Release button (A317)
7. Rewinding knob  
R Rewinding knob assembly (0-D6) - Nut (D15) - Washer (D21)  
- ASA dial assembly (0-D11-01)  
23600k-D4-A2
8. Top cover assembly (A300) - 4 screws - cover frame (A131)
9. Unsolder 12 lead wires and one contact piece  
Take out lead wires from cord holder  
Lead wire No. 21 (K100), No. 24 (T100), No. 22 and No. 23 (T100),  
No. 19 and No. 20 (N4), No. 15, No. 16, No. 17, No. 18 and one  
Contact piece (A129), No. 26 and No. 27 (0-A21).
10. ASA volume assembly (R100) - Top cover screw (A16) - CNL-d 1.7 x 2.5
11. Hot shoe contact piece (N4)
12. P.C. board retainer (I1) - W14
13. P.C. board retainer plate (N5) - T-CNS 1.7 x 5
14. LED retainer screw - CNL-D 1.4 x 2 - W31
15. P.C. board assembly (T100)
16. Front board and mirror housing  
Cocking the shutter  
Removing 5 screws - W14  
Shutter light seal cover (A8)
17. Bulb actuator plate (A504) - CNL-D 1.4 x 2
18. Cocked indicator assembly (0-C23)  
SW actuator lever shaft (C49)

19. Counter dial                      Back cover open  
    Counter dial spring (C57) - Counter retainer plate (C25),  
    Counter dial assembly (0-C34)  
    Come off transporting claw spring (C65)  
    Remove (C146) (C53) and CNS 1.7 x 3  
    Winding seat assembly (0-C2) - (0-C5) - (C7)
20. Shutter block (S000) - CNL-D 1.7 x 3 x 3
21. Bottom release assembly (0-C147)  
    Winding up little from bottom part with tool (23900K-C207-A)  
    To remove retainer screws of (0-C147).
22. Release plate assembly (A500)  
    Guide screw (A507) - Release plate restitution spring (A510).  
    When removing (A500), detach hook lever (C108) from (A500)
23. Shutter charge lever assembly (0-C129)  
    Loosening joint (C207) with tool (23900K-C207-A), remove (0-C129)  
    and (C144).  
    Fasten joint (C207) again.
24. Winding guide plate assembly (0-C102)
25. R lever assembly (0-C105)  
    LW-13 - (0-C105) - (C126)  
    (C145) - LW13 - (C144) - (C107) - (C130) - W14 - (C108) - W8 - (C125)  
    (C207) - (0-C106) - (0-C12).
26. Back cover assembly (0-C26)
27. Winding stopper assembly (0-C26)
28. Winding shaft assembly (0-C22) - Main gear (C30)
29. Sprocket shaft pin (C40) - Loosening set T 1.7 x 1.6
30. Top mec. Plate assembly (0-C1) - (C146) x 2 - CSS 1.7 x 3
31. Spool cam assembly (0-C202) and spool assembly (0-C204)  
    - W17 (t=0.2mm)

## Assembly Procedure

1. Spool assembly (0-C204) and spool cam assembly (0-C202)  
W17 (t=0.2mm)
2. Top mec. Plate assembly (0-C1)  
Pulling back transport indicator
3. Sprocket shaft pin (C40)  
Apply screw lock on Set T 1.7 x 1.6
4. Winding shaft assembly (0-C22) - Main gear (C30)

5. Winding stopper assembly (0-C26)

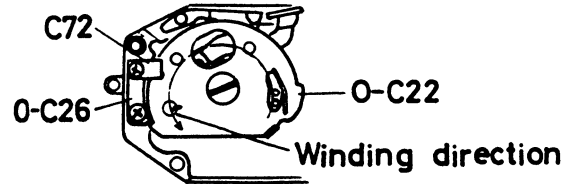

6. Winding spring assembly (0-C12)  
Proper tension of the spring is shown in figure.  
After installing (0-C12), install (0-C106) and (C207) temporarily.  
- 23900K-C207-A

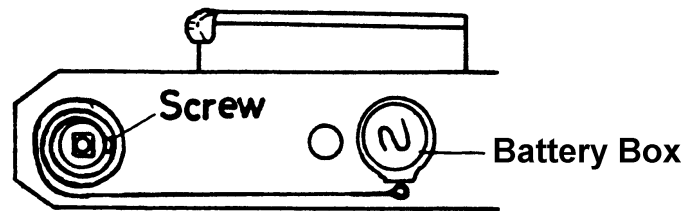

7. Perforation adjustment - Tool 23102-C57-A  
Same adjustment with K2 camera.  
Choosing proper 2nd gear (C31).
8. Bottom mechanism
  - a) (C125) - W8 (t=0.1) - Winding hook lever (C108) - W14 (t=0.05, 0.1) - (C130) - Winding lever ratchet (C107) - LW13 - (C145)
  - b) (C126) - R lever assembly (0-C105) - LW13
  - c) Winding guide plate assembly (0-C102) - (C146) - CSS 1.7 x 2.5 - CNS 1.7 x 3
  - d) Shutter charge lever assembly (0-C129)  
Loosening (C207) - (C144) - (0-C129) - fastening (C207)  
When fastening (C207), winding shaft should be in the wound position, at the same time, mirror charge lever (0-C102) should be moved to a correct position
9. Shutter release plate  
Release plate restitution spring (A510)  
(Take care to install spring in correct direction)  
Release plate assembly (A5000)  
(Take care not to bend winding hook lever (C108).)  
Guide screw (A507), connection spring (A511)  
(Engaging (A510) to (A500).)
10. Bottom release assembly (0-C147) - CNM 1.7 x 2.2, CNM 1.7 x 2.8  
Winding shutter a little

11. Shutter block (E000) - CNL-D 1.7 x 3 x3  
Light seal plate (A8)
12. Bulb actuator plate (A504) Temporary installation  
- CNL-D 1.4 x 2
13. Back cover assembly (A200)
14. Winding seat assembly (0-C2) - (C53), (C146), CNS 1.7 x 3  
Install (0-C2) with back cover open  
Winding lever click cam assembly (0-C5)  
Winding lever friction spring (C7)  
Engage transporting claw spring (C65)

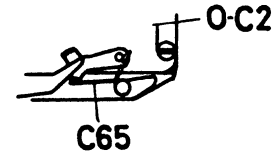

15. Counter transporting adjustment
  - a) Check the function of counter dial stopper lever (C4) and transporting claw assembly (C18).
  - b) If the vertical black lever of (0-C26) is bent forward, bend it straight.
  - c) Adjust the counter transporting function using the temporary counter transporting gear (C34).  
When back cover is closed, receiving claw (C16) and transporting claw (C18) should be engaged to the first tooth of (C34) simultaneously with enough gearing portion. Bend the tip of the claw which couples with the gear (C34), If not enough gearing portion.  
When back cover is opened, claw tip of (C16) must detach from the gear (C34) with a clearance of about 0.5mm.  
If there is not enough clearance, bend the other end of (C16) opposite from the claw as shown in the figure.

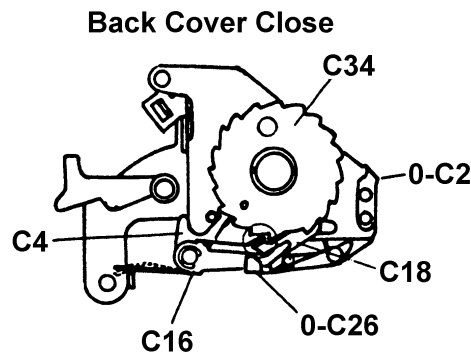
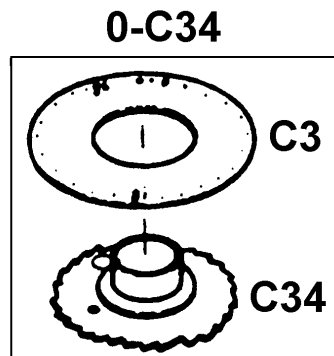

16. Counter dial

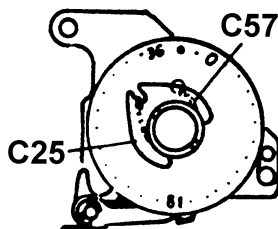

- Counter dial assembly (0-C34)  
Counter dial spring (C57)  
Counter retainer plate (C25)  
(C25) is installed in left side gutter as shown in figure.  
Give the spring (C57) 1/2 or 3/4 turns of tension.

17. Bulb off adjustment (Winding lever is at pre-advance position.)  
After releasing the first curtain, adjust "B" off position with eccentric screw riveted on bulb actuator plate (A504). When shutter rod comes back, 0.2mm clearance is necessary after releasing the 2nd curtain.

18. Cocked shutter assembly (0-C23) - SW actuator lever shaft.

19. Main SW adjustment = (I200)

When shutter actuator plate is held in "ON" position, 0.2mm clearance is necessary between longer contact piece of main SW and insulation blue collar.

To adjust the clearance, bend the shorter contact piece.

When both contact pieces touch each other, and the shorter contact piece is pulled down, the longer one should be down also as the shorter one does. If there is not enough tension on the longer contact piece, it may show uneven shutter speed.

When winding lever is at closed position, 0.2mm clearance is necessary between both contact pieces.

20. Front board and mirror housing

When the above mentioned parts are installed, shutter block (E000) should be cocked but not charge mirror housing.

Put on W14 (0.1mm) underneath front board and fasten it with (A132), pushing down left. Confirm the function of self-timer, shutter mechanism and mechanical back.

21. Parallax adjustment

22. P.C. board pattern assembly (T100)

(I1) - CNL-D 1.7 x 2.5 - (N5) - T-CNS 1.7 x 5 - (N4) - (N6 x 2)

23. ASA volume assembly (R100) - (A16) - CNL-D 1.7 x 2.5

24. Soldering 13 lead wires

25. Bottom cover assembly (A400) - (A23) - (C117)

26. LED positioning adjustment

27. Temporary top cover and installing ASA dial assembly (0-D11-01) and winding lever temporarily.

28. a) Shutter speed adjustment - VR-A

ASA 100, X1, f8, (KA-00-1A), 2.8V

EV12 - 1/60

EV16 - 1/1000

EV8 - 1/4

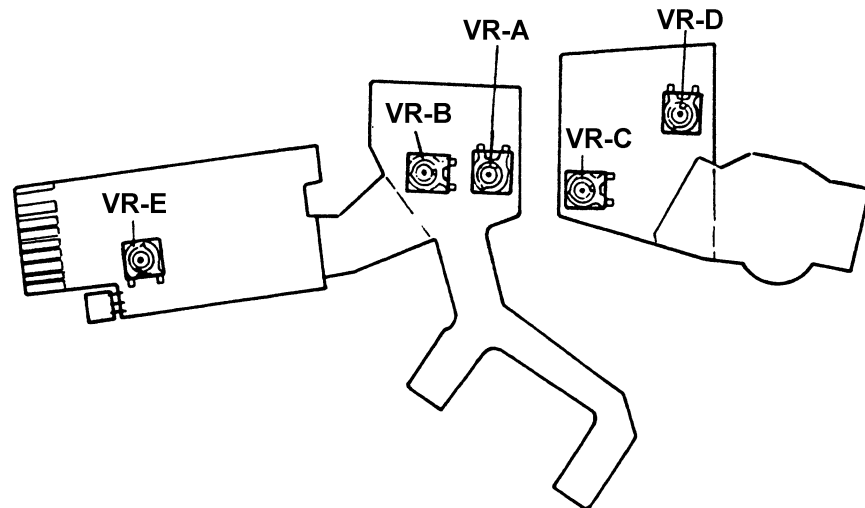
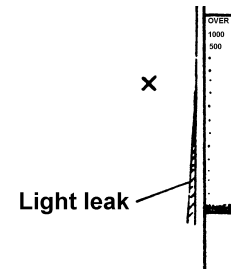

- b) LED indication adjustment  
 High EV (EV12), EV16) - VR-B  
 Low EV (EV8) - VR-C

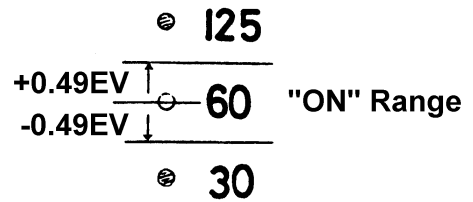

- c) Battery checker - VR-D  
 2.45V - Turning on and off (flickering)  
 2.55V - Turning on

d) VR-E is prohibited to adjust

29. Counter indication (C15) - (A300)

30. Top cover

(A131) - (A300)

Set shutter dial at "B"

Shutter restriction lever is set at left (viewing from back)

Put on top cover softly and fix it turning shutter dial to AUTO position

Four retainer screws

Rewinding parts, shutter dial, winding lever, etc.

31. Shutter stroke adjustment

a) Set shutter dial at "B"

b) 0.2mm clearance is necessary after releasing shutter.

Adjust the shutter stroke with eccentric screw.



32. X Synchronization with self-timer operation at "B"

When camera is operated with self-timer operation at "B" position, exposure time should be adjusted around 11~13ms.

To adjust the exposure time, bulb actuator plate (A504) should be moved up or down with eccentric screw.

Also check shutter dial 100X with self-timer operation in the same manner.

If camera is not adjusted as mentioned above, it is impossible to take pictures with complete synchronization with electronic flash, especially in the following combination such as shutter dial at 100X, winding lever at closed position and with self-timer operation.

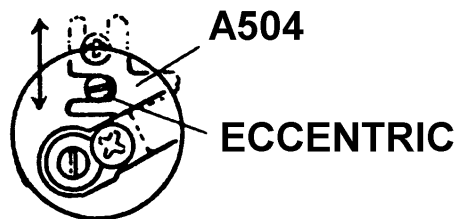

33. Focusing

34. Body covering, self-timer lever assembly (0-A118)  
 Self-timer screw (A122) - left-handed.

35. Disassembly of front board and mirror housing
- Remove self-timer (H000)
  - Mirror release lever (0-A111)
  - Mirror housing
  - Connector (I100) - only loosening (I2)
  - Unsolder 5 lead wires  
 Purple 2, orange 2, black 1

36. SWg, SWm located underneath mirror housing  
 SWg = Magnet switch  
 SWm = Memory switch

- a) SWg - Spring tension adjustment  
 8~10g spring tension is desirable: Check with tension gauge.

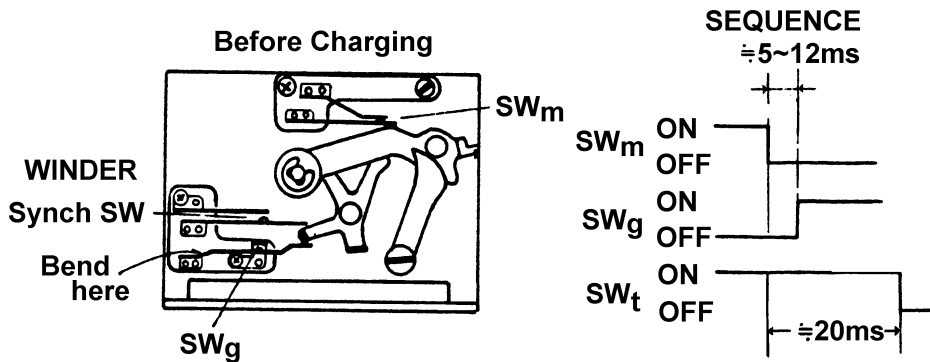

- b) SWm adjustment

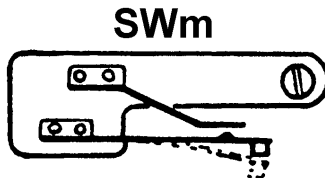

Bend longer contact piece as shown in figure.  
 Shorter contact piece should have proper tension.  
 (Check the tension after charging the mirror housing.)

- c) SWg adjustment

When mirror housing is charged, 0.2~0.3mm clearance is necessary between both contact pieces.  
 Bend longer contact piece as shown in figure.

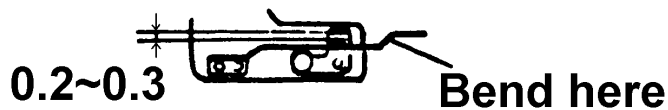



37. Adjustment of SWm and SWg  
Time lag sequence of SWm and SWg

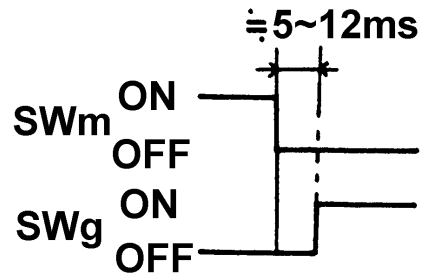

To check the time lag, an oscilloscope is necessary.  
The time lag is determined by the variation in voltage when SWm and SWg turn "ON" and "OFF".

Here is one example for time lag check with a single-trace oscilloscope.

**EX.**

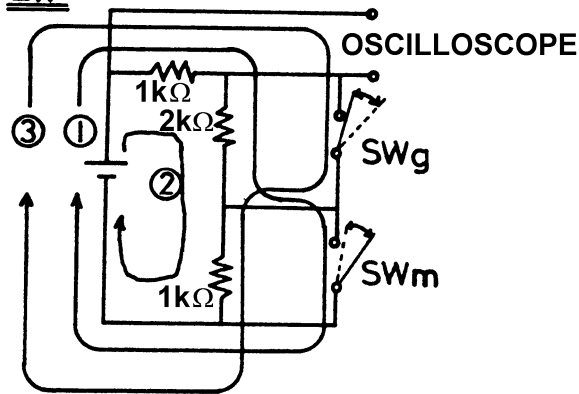

① (SWm-ON , SWg-OFF)

$$6V \times \frac{1K}{1K + 2K} = 2V$$

② (SWm-OFF , SWg-OFF)

$$6V \times \frac{1K}{1K+1K+2K} = 1.5V$$

③ (SWm-OFF , SWg-ON)

$$6V \times \frac{1K}{1K+1K} = 3V$$

Adapter should be made as shown below.

Adapter is connected to mirror housing connector and oscilloscope.  
After charging the mirror housing and releasing it to put the mirror in the "up" state, time lag appears on the oscilloscope screen.  
The adjustment procedures can be referred to in item 36.

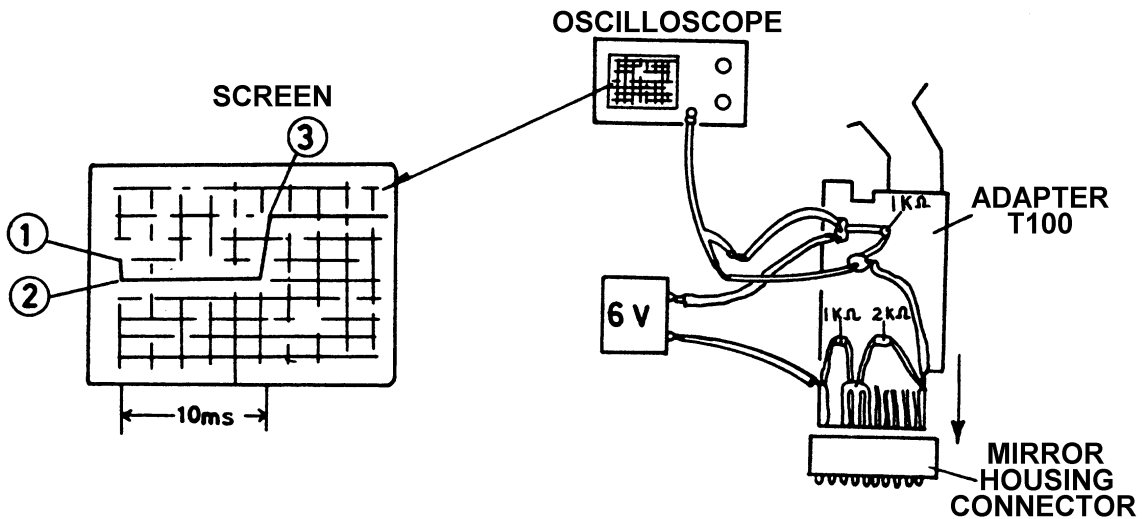

# PENTAX ME

## Notes and Troubleshooting Tips

### FIGURES:

- Fig. 1 - Top cover removed
- Fig. 2 - Bottom cover removed
- Fig. 3 - Front of camera, wind side
- Fig. 4 - Front view, mirror box removed
- Fig. 5 - Bottom of mirror box
- Fig. 6 - Current style, mirror switches
- Fig. 7 - Circuit for testing mirror switches
- Fig. 8 - Wiring diagrams
- Fig. 9 - Modified bottom cover

### ADJUSTMENT LOCATIONS:

Auto speeds	A	Fig. 1
Meter readout, high light	B	Fig. 1
Meter readout, low light	C	Fig. 1
Battery test	D	Fig. 1
Release overtravel	E	Fig. 3
Mechanical speed	F	Fig. 4
Travel time, 1st blade	G	Fig. 4
Travel time, 2nd blade	H	Fig. 4
Trigger switch (fast speed)	I	Fig. 4
Magnet switch	J	Fig. 5

### ADJUSTMENT VALUES:

Blade travel time:	6ms (20mm distance)
Flange-focal distance:	45.46mm (flange to film guide rails)
Release overtravel:	0.2mm additional travel of release slide after shutter releases
Mechanical speed:	11ms to 13ms exposure time when operated with self-timer action at bulb setting
Battery test:	Viewfinder LEDs to light steadily with 2.55V supplied and to flash on and off at 2.45V
Memory time lag:	Magnet switch SWg to close 10ms after memory switch SWm opens

#### ADJUSTMENT SEQUENCE:

##### 1. Auto speeds

Variable resistor A set: ASA 100, X1 compensation, f/8. With 2.8V supplied to the battery compartment, the shutter should deliver the following shutter speeds at the indicated light levels:

EV12 1/60 second  
EV16 1/1000 second  
EV8 1/4 second

##### 2. Meter Readout

EV 12 and 16                    Adjust variable resistor B  
EV8                                Adjust variable resistor C

Later versions of the flex circuit board have only one meter readout adjustment, Fig. 8.

##### 3. Battery test

Adjust variable resistor D for proper operation. Later versions of the flex circuit do not have the battery test adjustment. It is then only necessary to make an operational check.

#### AVOID DISTURBING:

Variable resistor VR-E on the memory circuit board (not accessible until the flex circuit has been removed). In some versions of the flex circuit, VR-E is at the top of the camera.

#### DISASSEMBLY HIGHLIGHTS:

##### Control positions:

Speed selector                    Auto  
Film speed                        Unimportant

##### Location of left-hand threads:

Winding lever cap screw  
Winding lever retaining nut  
Self-timer lever screw

##### Sequence:

1. Bottom cover (Loose parts: cover for power winder terminals and rewind button)
2. Top cover (Remove black ring at top of speed selector; top cover screw is then accessible through hole in speed selector)
3. Unsolder film speed resistor wires (two yellow) from flex circuit and from diaphragm resistor (if you're just removing the flex circuit, unsolder only the film-speed resistor wire that connects to the flex circuit)
4. Film-speed resistor (not necessary if you're just removing the flex circuit)
5. Unsolder red wires from flex circuit
6. screws holding hot shoe contact above eyepiece
7. Screw and clip that hold down photocell circuit board
8. Screw and circuit board retainer at rewind-side of camera
9. Screw and washer holding LED display at wind-lever side

10. Slide LED display out of focusing screen slot at wind-lever side
11. Lift out complete flex circuit (Underside of flex circuit may be glued to top of pentaprism)
12. Unsolder 5 leads form front-plate circuit board
13. Unsolder green wire and blue wire from power winder terminals
14. Rewind-side leatherette; peel back wind-side leatherette far enough to reach front plate screws
15. Cock shutter
16. Screw at top rear of mirror cage, wind-lever side
17. 4 front-plate screws
18. Front-plate/mirror-box assembly
19. Winding-seat assembly (3 screws)
20. Shutter assembly (3 screws)

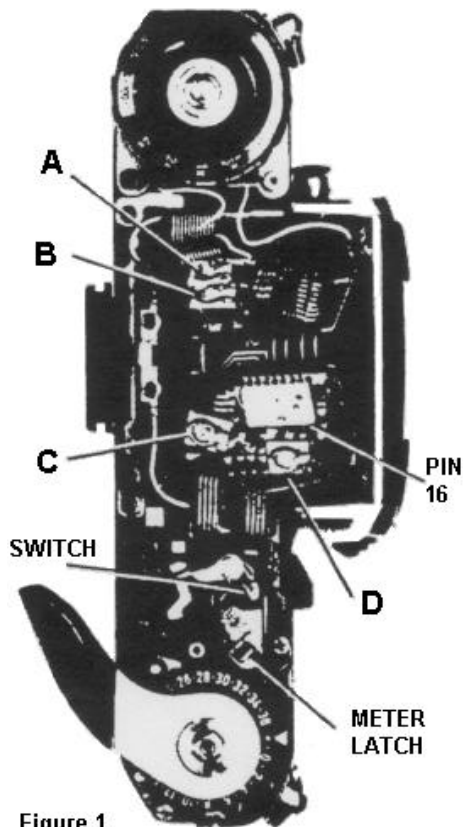

Figure 1

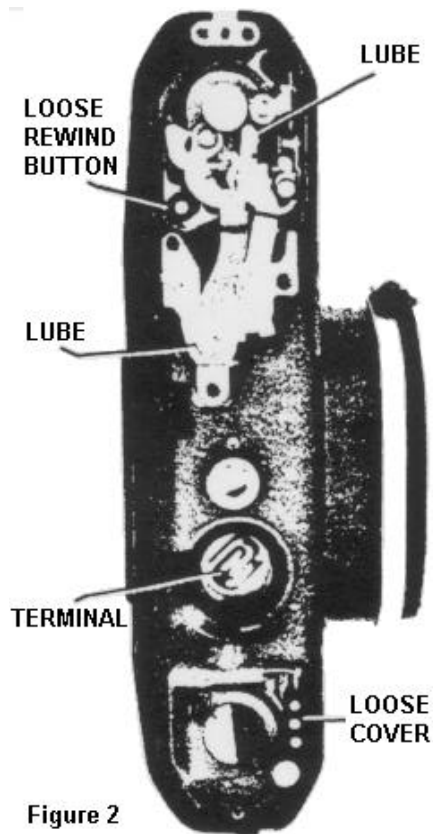

Figure 2

REASSEMBLY HIGHLIGHTS:

1. Replace the mirror-box with the mirror in the released position and the shutter in the cocked position
2. To replace the top cover, set the speed selector to the Bulb ("B") position and the wind-lever shaft to the closed position. Then seat the top cover and turn the speed selector to the auto setting.

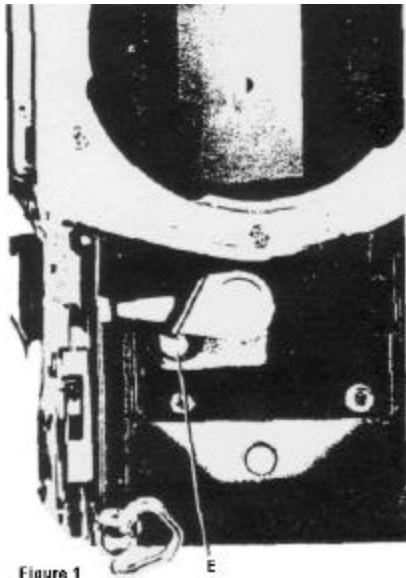

Figure 1

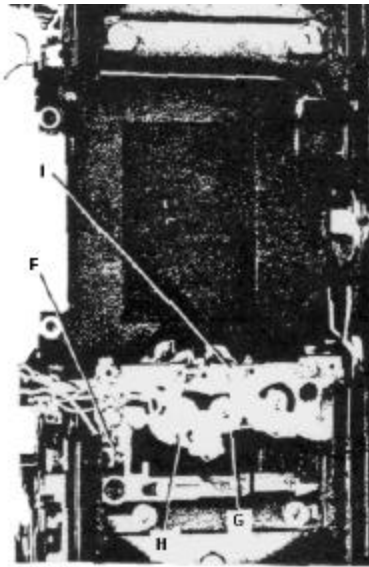

Figure 2

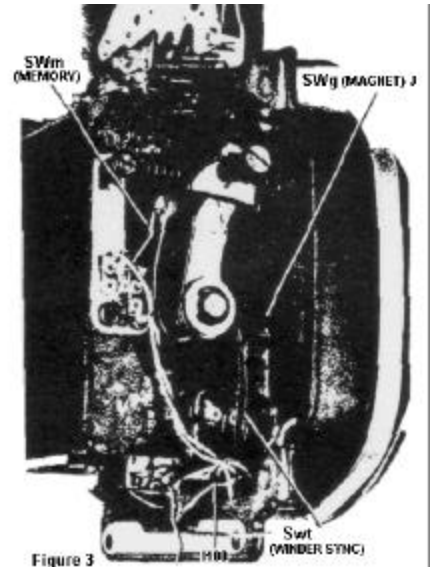

Figure 3

#### TROUBLESHOOTING:

##### Typical battery drain

Meter: 1.7-2.0mA  
 Shutter open: 10mA

##### Behaviour with batteries

Fastest speed only except at mechanical shutter settings

##### Replacement parts

Circuit board T100 and Seiko shutter E000 available from Pentax only as complete modules; other parts available individually

##### Troubleshooting steps for specific problems

1. *Shutter gives only mechanical speed at auto, LEDs don't turn on*

##### Battery voltage at flex circuit

Check for +3V between ground and each red wire at top of flex circuit. No voltage: check battery box and red wire solder connections.

##### Main switch

Check for +3V at center lead (uninsulated connector) to front-plate circuit board A129 with release-side partially depressed. No voltage: check main switch for poor contact. You can also check the main switch by shorting between the red wire at the flex circuit and the center terminal at the front-plate circuit board. The short should turn on the meter. If it does, the main switch is the problem.

2. *Auto-exposure erratic, shutter sometimes delivers mechanical speed only.*

Memory time lag  
Chattering in magnet switch

Check the timing between the magnet switch and the memory switch by plugging the modified circuit board (Fig. 7) into the mirror-box connector I100. Power the special circuit board with a 6V DC power supply. Then measure across the switch with an oscilloscope as you release the mirror-box. You should measure a time lag of 10-12ms between the moment the memory switch opens and the moment the magnet switch closes. Adjust the time lag by reforming the long blade of the magnet switch at the point indicated in Fig. 5. The oscilloscope test also allows you to see chattering in the magnet switch.

3. *Shutter delivers only fastest speed at auto, LEDs operate OK*

Electromagnet  
Check the continuity of the electromagnet coil between the blue wire and brown wire at the front-plate circuit board. You should measure approximately 350 Ohms.

Magnet switch SWg  
The magnet switch (Fig. 5) should close as the diaphragm-closing lever starts to move down. You should then measure direct continuity between the orange wire and the black wire (Fig. 7). To check the magnet switch without removing the mirror-box, you can use the modified circuit board shown in Fig. 7. From the top of the camera, proceed with the disassembly far enough to lift out the memory circuit board. Check for direct continuity between the orange-wire connection and the black-wire connection with the shutter held open on Bulb. No continuity: Magnet switch is not closing.

4. *Power winder transports film during exposure*

Winder sync switch  
Check the continuity between the green-wire power winder terminal (Fig. 2) and ground. You should measure direct continuity with the shutter open, indicating that the winder sync switch (Fig. 5) has closed.

Malfunctions resulting from poor solder connections or poor contact at mirror-box connector I100

1. Violet - LEDs work, shutter hangs open or delivers slow speed
2. Orange - LEDs work but continue to charge with mirror up  
Shutter delivers mechanical action only
3. Violet - LEDs work, shutter hangs open or delivers slow speed

4. Yellow - "Over" LED remains on, shutter delivers mechanical action only
5. White - LEDs work, shutter delivers mechanical action only
6. Blue - LEDs do not work, shutter delivers mechanical action only
7. Brown - LEDs work, shutter delivers mechanical action only
8. Black - LEDs do not work, shutter delivers mechanical action only

#### Tips for troubleshooting without disassembly

1. If the camera jams, check to see if the LEDs remain on. This condition normally indicates that the release side has jammed underneath the meter latch (Fig. 1). The problem may occur in early models if the user turns the speed selector to the lock position during a long exposure. Refer to the "Revised Parts" section.
2. Check to see if the power winder will turn on the meter by shorting between the red-wire terminal and the blue-wire terminal (Fig. 2). The short should turn on the LEDs.

#### REVISED PARTS

- a. The memory switch and magnet switch shown in Fig. 5 have been replaced with the assembly shown in Fig. 6. They are interchangeable. Connect the violet wires to the memory switch and the orange wires to the magnet switch.

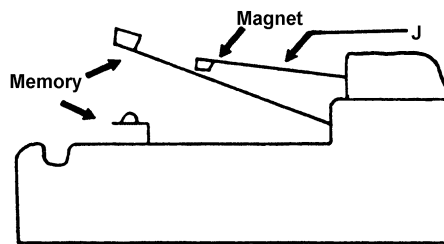

Figure 6 - Mirror-box switches with mirror up

- b. The flex circuit has been physically changed several times, but the electronic operation remains the same. The complete pictorial (Fig. 7) shows the early style; the partial pictorials show the differences in later styles.
- c. The upper end of the release slide has been cut at a slant to avoid the possibility of catching under the meter latch. In the early cameras, you can prevent the problem by cementing a spacer (part #23900) to the bottom cover (Fig. 9). The spacer limits the travel of the release slide.

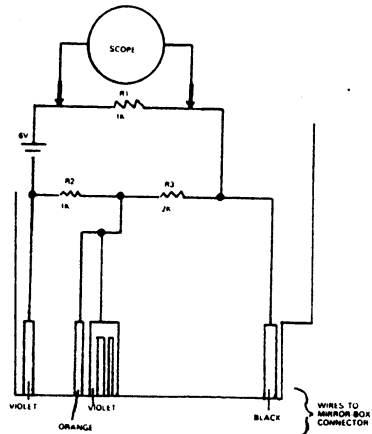
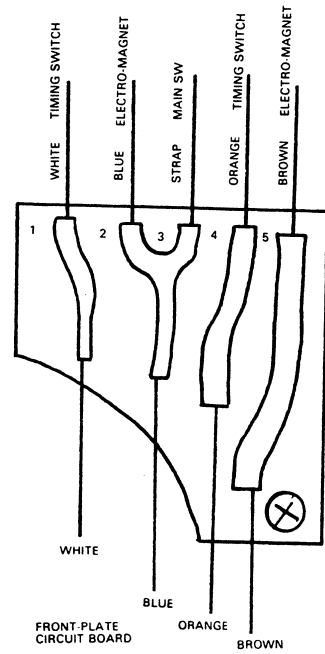

Figure 7



FRONT-PLATE CIRCUIT BOARD

VOLTAGES AT TERMINALS WITH MAIN SWITCH CLOSED:

- 1. 0.6 - 0.7V
- 2. 3V
- 3. 3V
- 4. 0.6 - 0.7V (0V WITH SHUTTER OPEN)
- 5. 3V (CLOSE TO 0V DURING EXPOSURE)

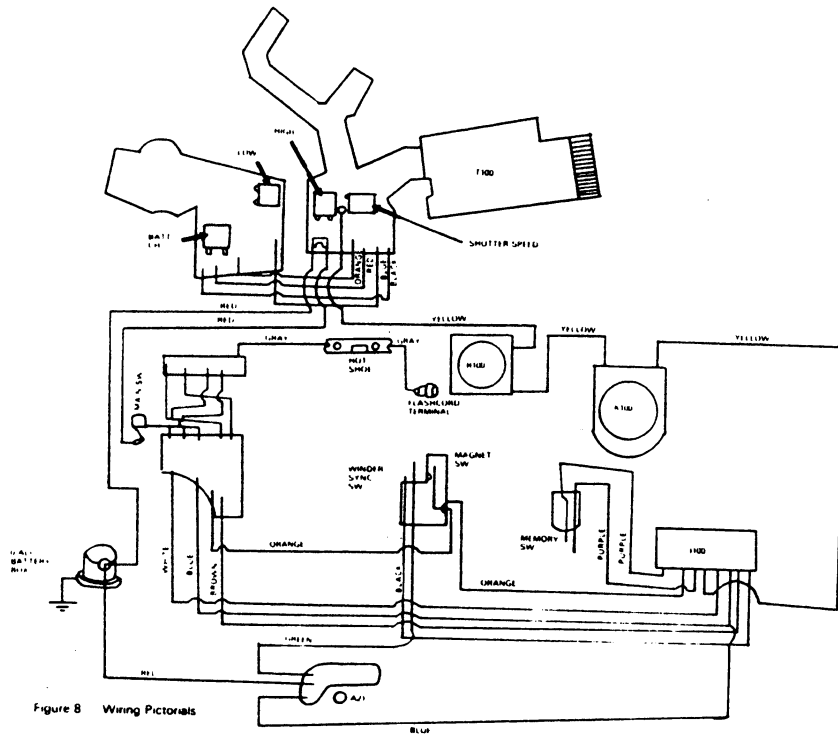

Figure 8 Wiring Pictorial

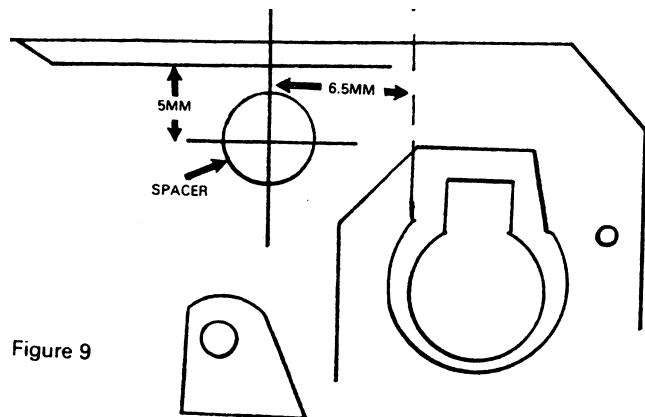
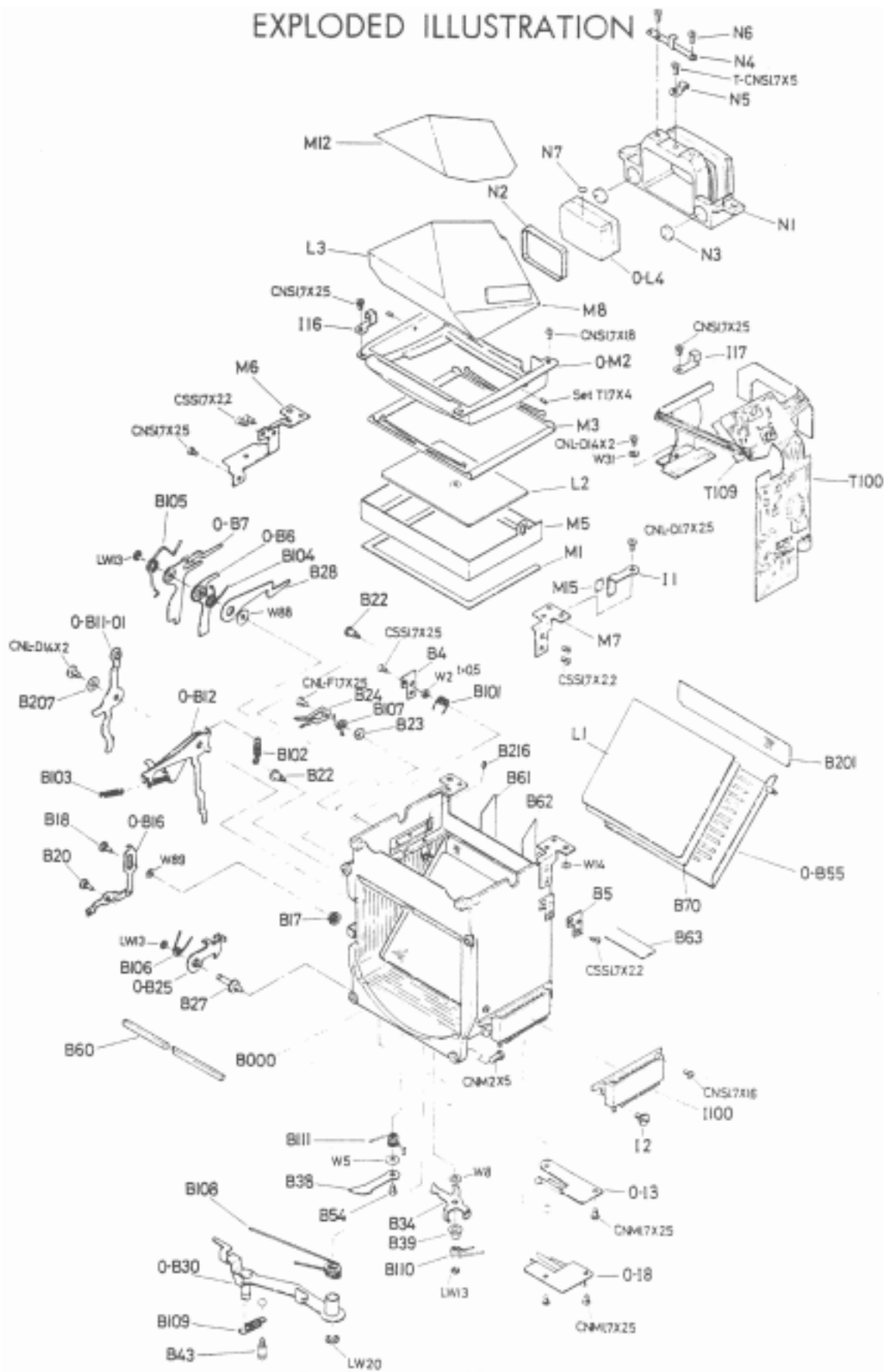

Figure 9





# EXPLODED ILLUSTRATION



Product No. 23900

ASAHI PENTAX **IME**

Fig. 2



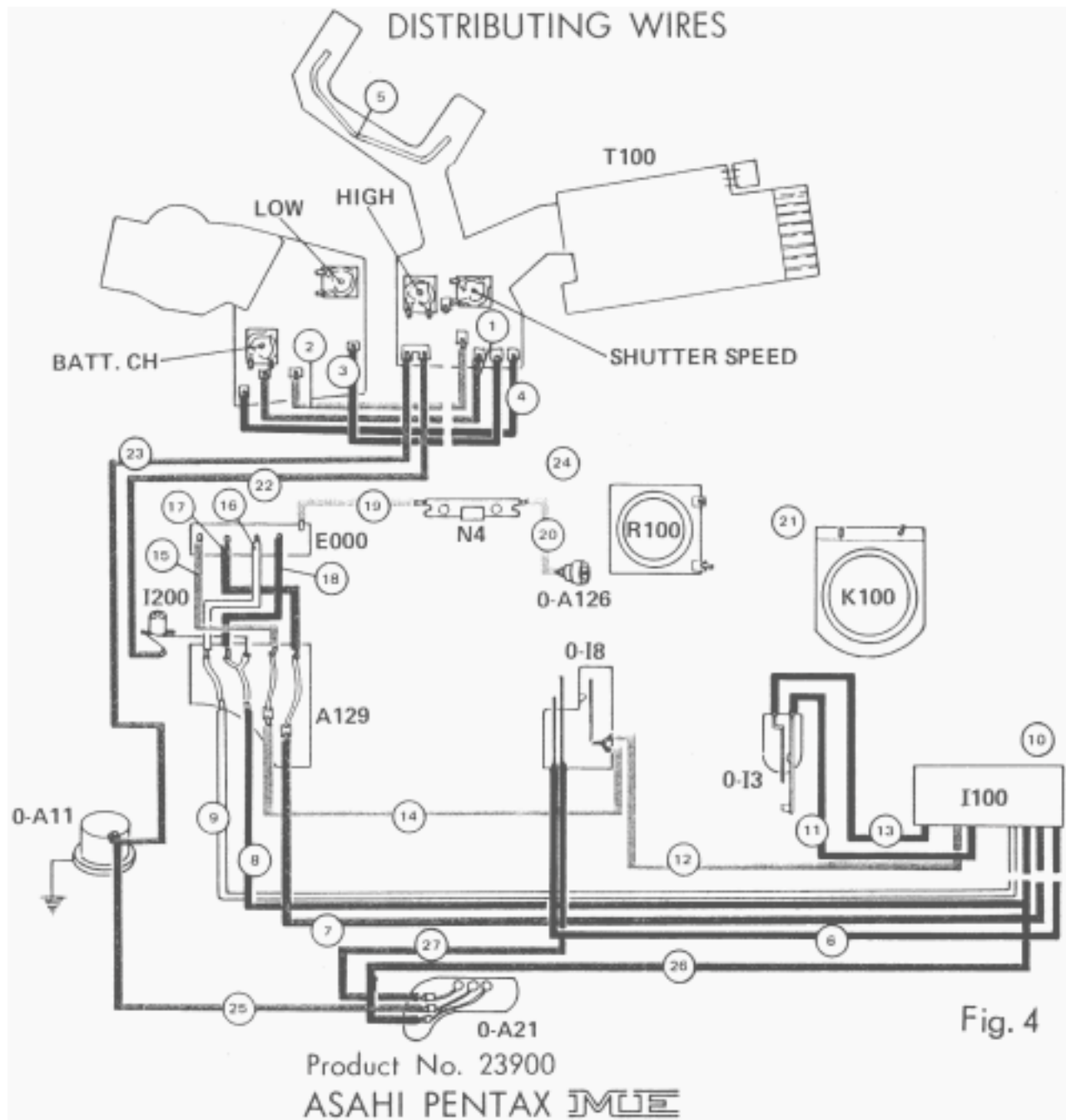

Fig. 4